

Mobilya Kulpları

Furniture Handles

“İyi Fikirler, İyi Çözümler...”

17



Orion Serisi / Series



Ölçüler:	Krom Chrome	Saten Satin Nickel	Antik Bronz Antique Bronze	Altın Brass	Siyah Black
128	260290	317427	293611	252021	258183
192	256124	314366	282559	252022	265512
256	307976	314367	314407	252023	319827

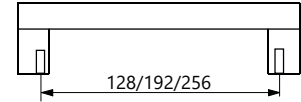

TEKNİK DETAYLAR / Details

> Basıncılı Zamak Metal

Orion Serisi / Series

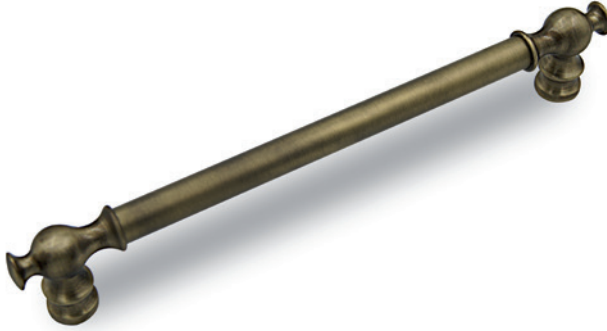

Ölçüler:	Krom Chrome	Saten Satin Nickel	Antik Bronz Antique Bronze	Altın Brass	Siyah Black
128	251997	263445	252005	252001	252013
192	251998	263462	252006	252002	252014
256	251999	319660	317251	314410	252015

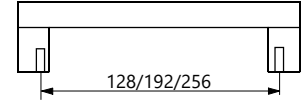

TEKNİK DETAYLAR / Details

> Basıncılı Zamak Metal

192 Serisi / Series



Mat Krom Matte Chrome	Saten Satin Nickel
009783	009784

TEKNİK DETAYLAR / Details

> Basıncılı Zamak Metal

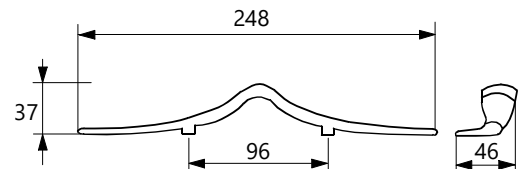

940 Serisi / Series

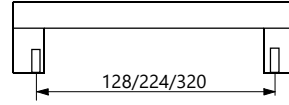

Saten
Satin

Ölçüler:

128	333557
224	333558
320	333559

TEKNİK DETAYLAR / Details

> Basıncılı Zamak Metal

937 Serisi / Series

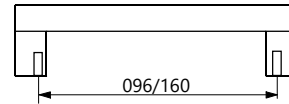

Saten
Satin

Ölçüler:

096	333560
160	333561

TEKNİK DETAYLAR / Details

> Basıncılı Zamak Metal

917 Serisi / Series

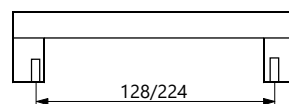

Saten
Satin

Ölçüler:





128	333562
224	333563

TEKNİK DETAYLAR / Details

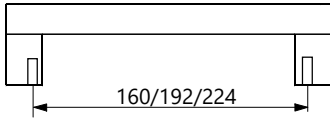
> Basıncılı Zamak Metal

158 Serisi / Series



	Krom Chrome	Saten / İnkoks Satin Nickel	Antik Bronz Antique Bronze	Altın Brass	Siyah Black
Ölçüler:					
Tekli	333564	333565	333566	333567	333568
160	333569	333570	333571	333572	333573
192	333574	333575	333576	333577	333578
224	333579	333580	333581	333582	333583

TEKNİK DETAYLAR / Details

> Basıncılı zamak metal

351 Serisi / Series

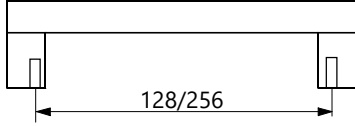

Ölçüler:	Krom Chrome	Saten Satin Nickel	Antik Bronz Antique Bronze	Altın Brass	Siyah Black
128	333584	333585	333586	333587	333588
256	333589	333590	333591	333592	333593

TEKNİK DETAYLAR / Details

> Basıncılı zamak metal

594 Serisi / Series

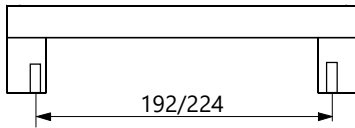

Ölçüler:	Krom Chrome	Saten Satin Nickel	Antik Bronz Antique Bronze	Altın Brass	Siyah Black
192	333594	333595	333596	333597	333598
224	333599	333600	333601	333602	333603

TEKNİK DETAYLAR / Details

> Basıncılı zamak metal

**549920 Serisi / Series**Fırça San
Brushed Brass

333531

İnox
Inox

333532

Siyah
Black

333533

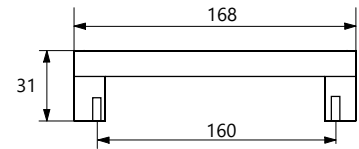
**TEKNİK DETAYLAR / Details**

> Basıncılı zamak metal

240330 Serisi / Series

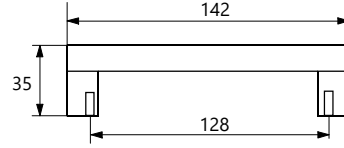
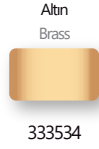

TEKNİK DETAYLAR / Details

> Basıncılı zamak metal

241930 Serisi / Series



TEKNİK DETAYLAR / Details

> Basıncılı zamak metal

344 Serisi / Series



Antik Demir
Antique Iron



Antik Bronz
Antique Bronze



Ölçüler:

Ölçüler:	Antik Demir Antique Iron	Antik Bronz Antique Bronze
128	321366	321363
192	321367	321364
320	321368	321365

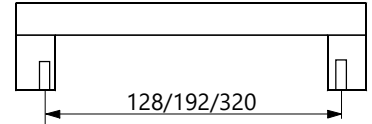

TEKNİK DETAYLAR / Details

> Basıncılı Zamak Metal

309 Serisi / Series



Antik Demir
Antique Iron



Antik Bronz
Antique Bronze



Ölçüler:

Ölçüler:	Antik Demir Antique Iron	Antik Bronz Antique Bronze
128	321361	321359
192	321362	321360

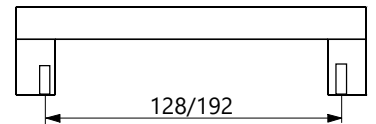

TEKNİK DETAYLAR / Details

> Basıncılı Zamak Metal

3H Serisi / Series



Saten
Satin Nickel

Ölçüler (mm)

	A	B	C	D	E
009737	156	096	32	14	30
009740	252	192	32	14	30
009741	284	224	32	14	30
009742	315	256	32	14	30
009744	380	320	32	14	30
009745	476	416	32	14	30
009746	508	448	32	14	30
009748	660	600	32	14	30
009749	760	700	32	14	30

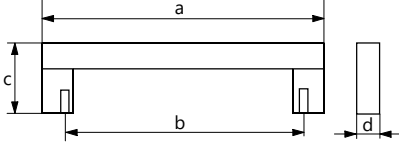

TEKNİK DETAYLAR / Details

> Paslanmaz

835 Serisi / Series



Krom
Chrome

İnoks
Inox

Ölçüler:



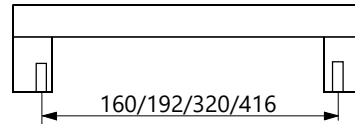

160	056078	056077
192	056076	056075
320	056074	056073
416	056072	056071

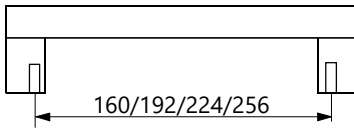

TEKNİK DETAYLAR / Details

> Basıncılı Zamak Metal

359 Serisi / Series

	Krom Chrome	Saten Satin Nickel	Antik Bronz Antique Bronze	Altın Brass	Siyah Black
Ölçüler:					
160	333604	333606	333607	333608	333609
192	333610	333611	333612	333613	333614
224	333615	333616	333617	333618	333619
256	333620	333621	333622	333623	333624

TEKNİK DETAYLAR / Details

> Basıncılı Zamak Metal

360 Serisi / Series

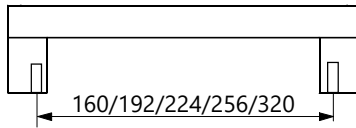





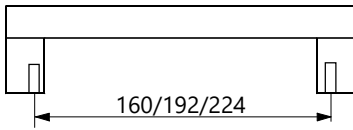

	Krom Chrome	Saten Satin Nickel	Antik Bronz Antique Bronze	Altın Brass	Siyah Black
Ölçüler:					
160	333625	333626	333627	333628	333629
192	333630	333631	333632	333633	333634
224	333635	333636	333637	333638	333639
256	333640	333641	333642	333643	333644
320	333645	333646	333647	333648	333649

TEKNİK DETAYLAR / Details

> Basıncılı Zamak Metal

153 Serisi / Series



	Krom Chrome	Saten Satin Nickel	Antik Bronz Antique Bronze	Altın Brass	Siyah Black
Ölçüler:					
160	333652	333653	333655	333656	333657
192	333658	333659	333660	333661	333662
224	333663	333664	333665	333666	333667

TEKNİK DETAYLAR / Details

> Basıncılı Zamak Metal

551 Serisi / Series

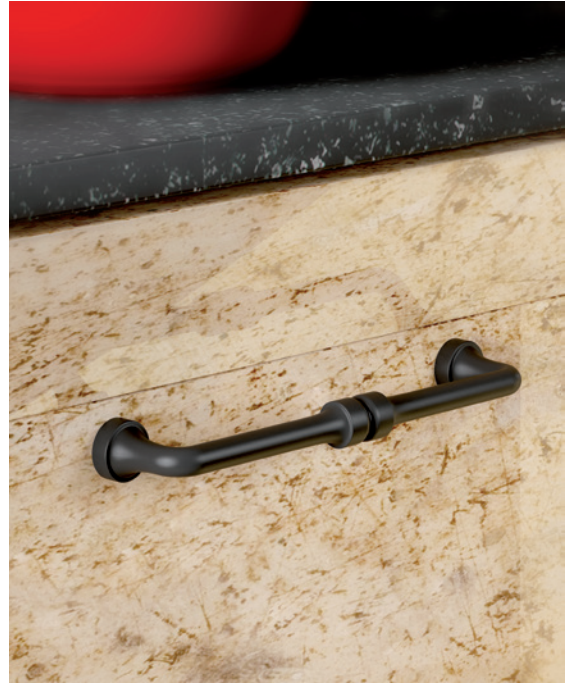

Bronz
Bronze

İnoks
Inox

Siyah
Black

Krom
Chrome

Ölçüler:



128	327635	327633	320902	334320
160	322692	320280	320628	334322

TEKNİK DETAYLAR / Details

> Basıncılı Zamak Metal

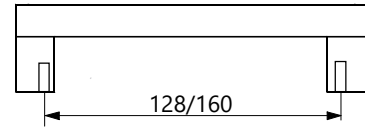

650 Serisi / Series



Saten
Satin Nickel



053353

TEKNİK DETAYLAR / Details

> Basıncılı Zamak Metal

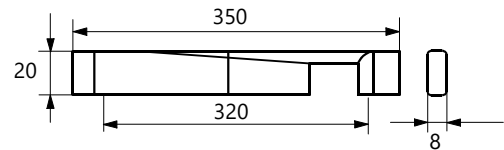

572 Serisi / Series

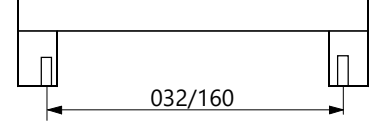

Ölçüler:	Krom Chrome	Saten Satin Nickel	Antik Bronz Antique Bronze	Altın Brass	Siyah Black
032	333668	333669	333670	333671	333672
160	333673	333674	333675	333676	333677

TEKNİK DETAYLAR / Details

> Basıncılı Zamak Metal

574 Serisi / Series

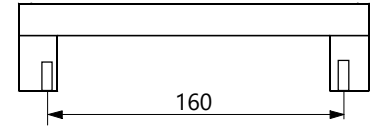

Ölçüler:	Krom Chrome	Saten Satin Nickel	Antik Bronz Antique Bronze	Altın Brass	Siyah Black
Tekli	333678	333679	333680	333681	333682
160	333683	333684	333685	333686	333687

TEKNİK DETAYLAR / Details

> Basıncılı Zamak Metal

354 Serisi / Series

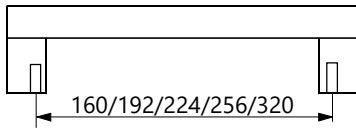

	Krom Chrome	Saten Satin Nickel	Antik Bronz Antique Bronze	Altın Brass	Siyah Black
Ölçüler:					
160	333688	333689	333690	333691	333692
192	333693	333694	333695	333696	333697
224	333700	333701	333702	333703	333704
256	333705	333706	333707	333708	333708
320	333710	333711	333712	333713	333714

TEKNİK DETAYLAR / Details

> Basıncılı Zamak Metal

949 Serisi / Series



Krom
Chrome

Ölçüler:

96	333715
192	333716
320	333717

TEKNİK DETAYLAR / Details

> Basıncılı Zamak Metal

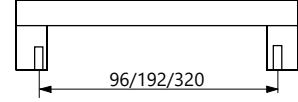

910 Serisi / Series



Krom
Chrome



060994

Mat Krom
Matt Chrome



073373

İnoks
Inox



073374

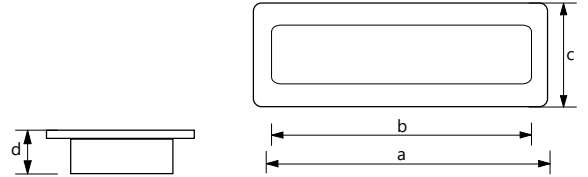

Ölçüler (mm)

A	B	C	D
183	160	50	23

TEKNİK DETAYLAR / Details

> Basıncılı Zamak Metal

204 Serisi / Series



İnoks
Inox

Ölçüler:

102	082341
150	160818
200	160819

TEKNİK DETAYLAR / Details

> Paslanmaz

Ölçüler (mm)

A	B	C	D
72	102	51	12
122	150	51	12
172	200	60	17

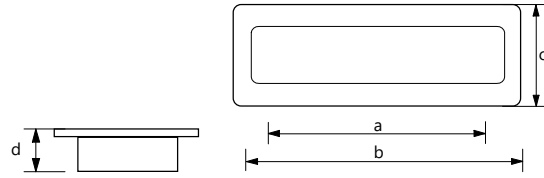

Kare Serisi / Series

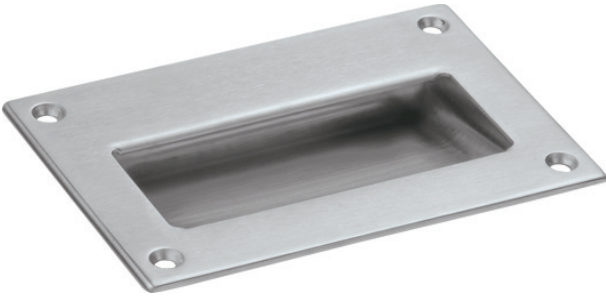

Saten
Satin Nickel



004683

TEKNİK DETAYLAR / Details

> Paslanmaz

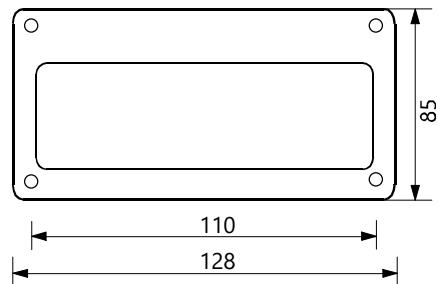

Mobilya Kulpları Furniture Handles

900 Serisi / Series

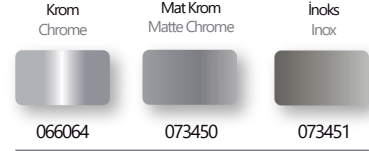
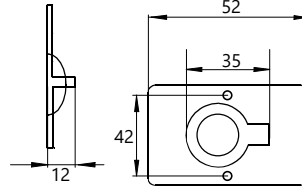

TEKNİK DETAYLAR / Details

> Basınçlı Zamak Metal

GMC-004 Serisi / Series

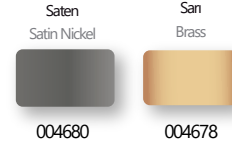
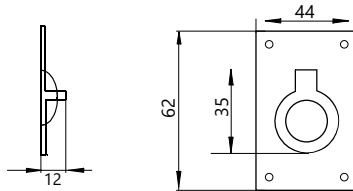

TEKNİK DETAYLAR / Details

> Paslanmaz

210 Serisi / Series

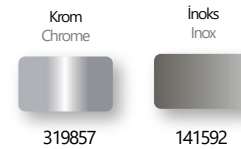
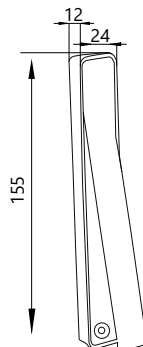

TEKNİK DETAYLAR / Details

> Basınçlı Zamak Metal

145 Serisi / Series

Saten
Satin Nickel



052849

TEKNİK DETAYLAR / Details

> Basıncılı Zamak Metal

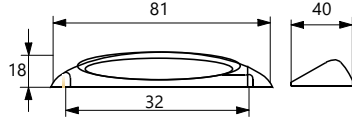

821 Serisi / Series

Krom
Chrome



066066

Mat Krom
Matt Chrome



073428

İnoks
Inox



073429

TEKNİK DETAYLAR / Details

> Basıncılı Zamak Metal

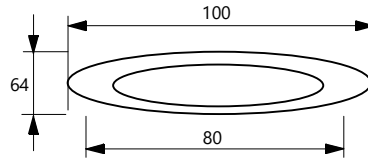

101 Serisi / Series

Saten
Satin Nickel



009758

TEKNİK DETAYLAR / Details

> Basıncılı Zamak Metal

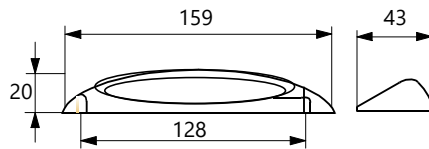

3H134 Serisi / Series

Saten
Satin Nickel



054123

Krom
Chrome



054122

TEKNİK DETAYLAR / Details

> Alüminyum / Basıncılı Zamak Metal

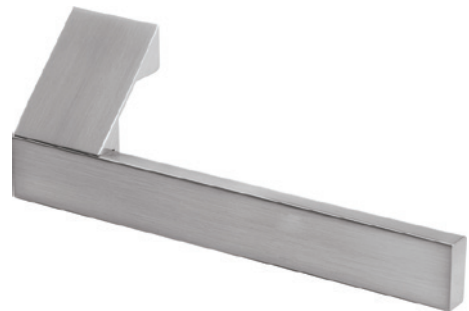
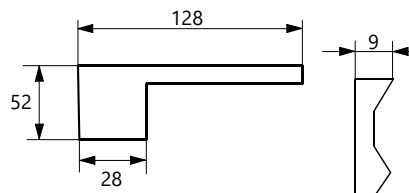



380 Serisi / Series

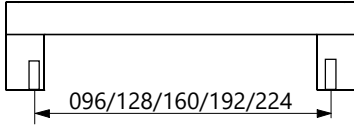
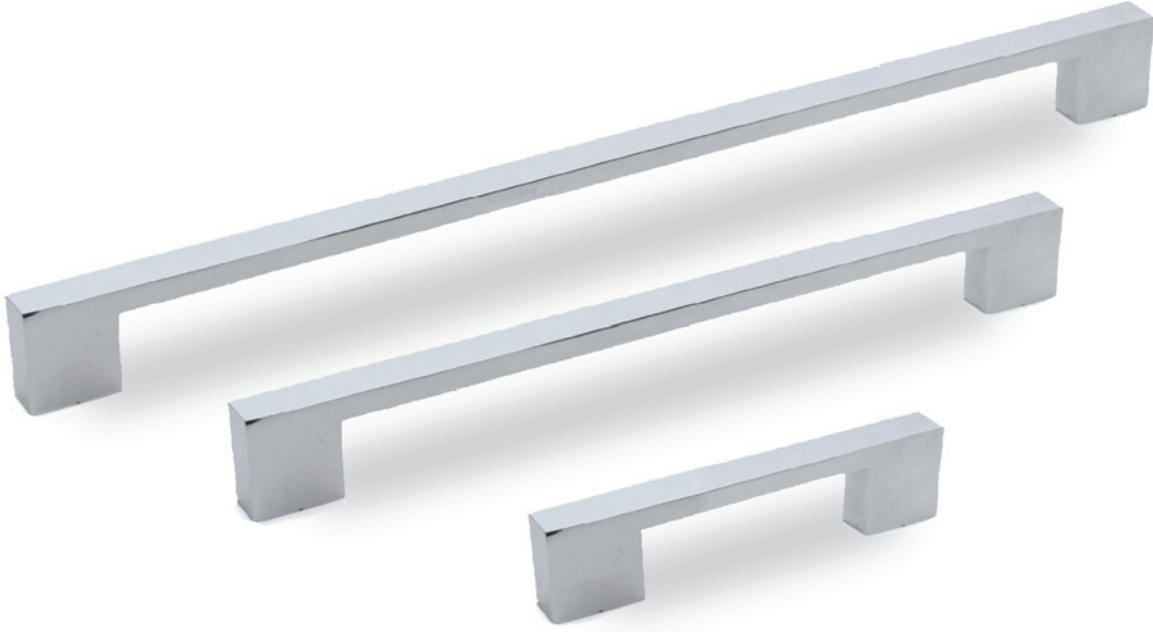





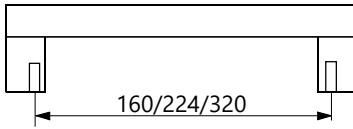

	Krom Chrome	Saten Satin Nickel	Antik Bronz Antique Bronze	Altın Brass	Siyah Black
Ölçüler:					
96	333718	333719	333720	333721	333722
128	333723	333724	333725	333726	333727
160	333728	333729	333730	333731	333732
192	333733	333734	333735	333742	333736
224	333737	333738	333739	333740	333741

TEKNİK DETAYLAR / Details

> Basıncılı Zamak Metal

348 Serisi / Series



	Krom Chrome	Saten Satin Nickel	Antik Bronz Antique Bronze	Altın Brass	Siyah Black
Ölçüler:					
Tekli	333743	333744	333745	333746	333747
160	333748	333749	333750	333751	333752
224	333753	333754	333755	333756	333757
320	333758	333759	333760	333761	333762

TEKNİK DETAYLAR / Details

> Basıncılı Zamak Metal

1040 Serisi / Series

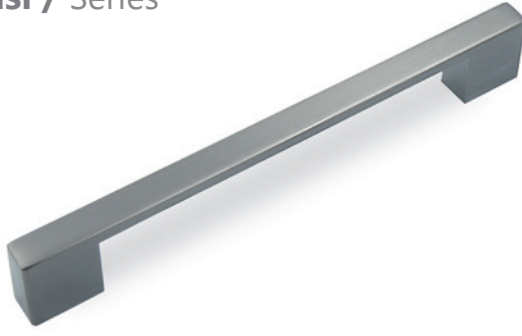

Ölçüler:	Saten Satin Nickel	Antrasit Anthracite	Siyah Black	Antik Bronz Antique Bronze	Altın Brass
160	334115	334116	334295	334119	335004
224	334114	334117	334294	334120	335005
320	334113	334118	334955	334121	335006
416	335651	334879	334880	335652	335653

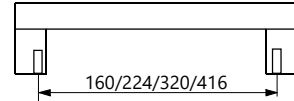

TEKNİK DETAYLAR / Details

> Basıncılı Zamak Metal

1107 Serisi / Series



Ölçüler:	Krom Chrome	Saten Satin Nickel	Siyah Black
Tekli	328390	328391	328393
160	328386	328387	328389
320	328382	328383	328385

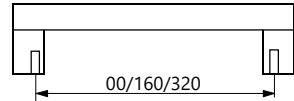

TEKNİK DETAYLAR / Details

> Basıncılı Zamak Metal

317 Serisi / Series



Ölçüler:	S. Saten S. Satin	Antik Bronz Antique Bronze	Siyah Black
192	328390	328391	328393
256	328386	328387	328389

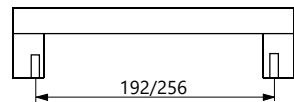

TEKNİK DETAYLAR / Details

> Basıncılı Zamak Metal

866 Serisi / Series



Krom
Chrome

Ölçüler:

160	060193
224	060191

TEKNİK DETAYLAR / Details

> Basıncılı Zamak Metal

832 Serisi / Series



Krom
Chrome

Ölçüler:

160	056062
192	056060
320	056058

TEKNİK DETAYLAR / Details

> Basıncılı Zamak Metal



770 Serisi / Series

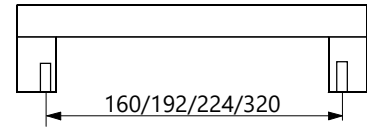
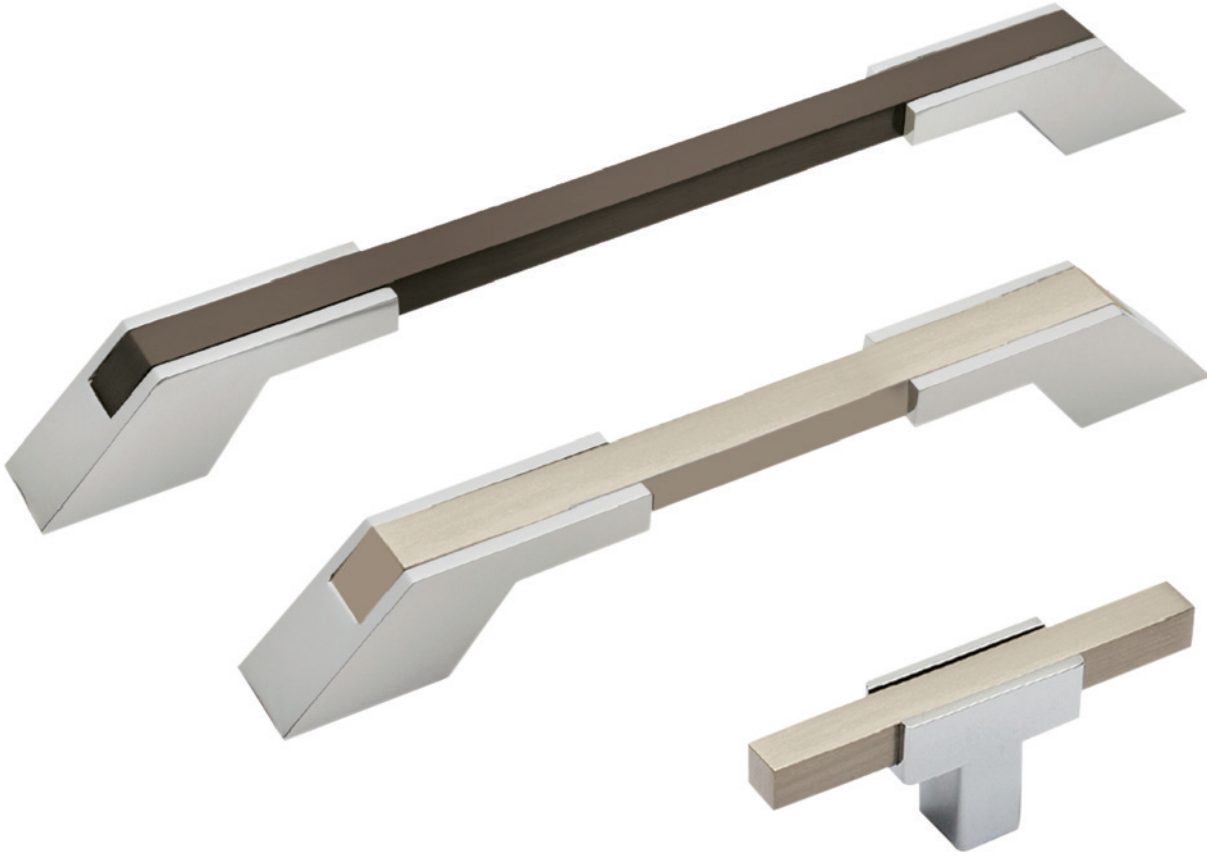

Ölçüler:	Krom Chrome	Krom İnkoks Chrome Inox	Krom Altın Chrome Brass	Krom Siyah Chrome Black
160	333768	333772	333776	333780
192	333769	333773	333777	333781
224	333770	333774	333778	333782
320	333771	333775	333779	333783

TEKNİK DETAYLAR / Details

> Basıncılı Zamak Metal



546 Serisi / Series

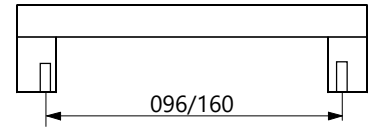

Ölçüler:	Krom Chrome	Saten Satin Nickel	Antik Bronz Antique Bronze	Altın Brass	Siyah Black
Tekli	333784	320240	320241	333785	320239
96	333786	320233	320235	333788	320234
160	333789	320238	320236	333790	320237

TEKNİK DETAYLAR / Details

> Basınçlı Zamak Metal

371 Serisi / Series

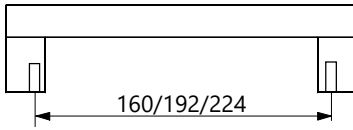

Krom
Chrome



Saten
Satin Nickel



Antik Bronz
Antique Bronze



Altın
Brass



Siyah
Black



Ölçüler:

160	333791	333792	333793	333794	333795
192	333796	333797	333798	333804	333805
224	333799	333800	333801	333802	333803

TEKNİK DETAYLAR / Details

> Basıncılı Zamak Metal

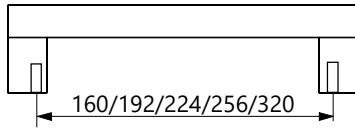
365 Serisi / Series

	Krom Chrome	Saten Satin Nickel	Antik Bronz Antique Bronze	Altın Brass	Siyah Black
Ölçüler:					
160	333806	333807	333808	333809	333810
192	333811	333812	333813	333814	333815
224	333816	333817	333818	333819	333820

TEKNİK DETAYLAR / Details

- > Basıncılı Zamak Metal
- > Ölçüler: 160, 192, 224, 256, 320

550 Serisi / Series

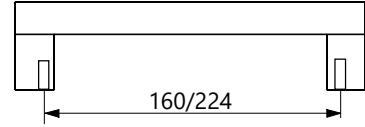

Ölçüler:	Krom Chrome	Saten Satin Nickel	Antik Bronz Antique Bronze	Altın Brass	Siyah Black
160	333821	333822	333823	333824	333825
224	333826	333827	333828	333829	333830

TEKNİK DETAYLAR / Details

> Basıncılı Zamak Metal

551 Serisi

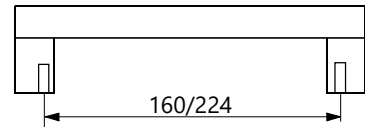

Ölçüler:	Krom Chrome	Saten Satin Nickel	Antik Bronz Antique Bronze	Altın Brass	Siyah Black
160	333831	333832	333833	333834	333835
224	333836	333837	333838	333839	333840

TEKNİK DETAYLAR / Details

> Basıncılı Zamak Metal

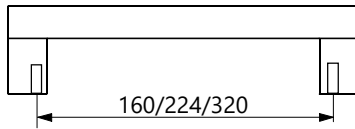
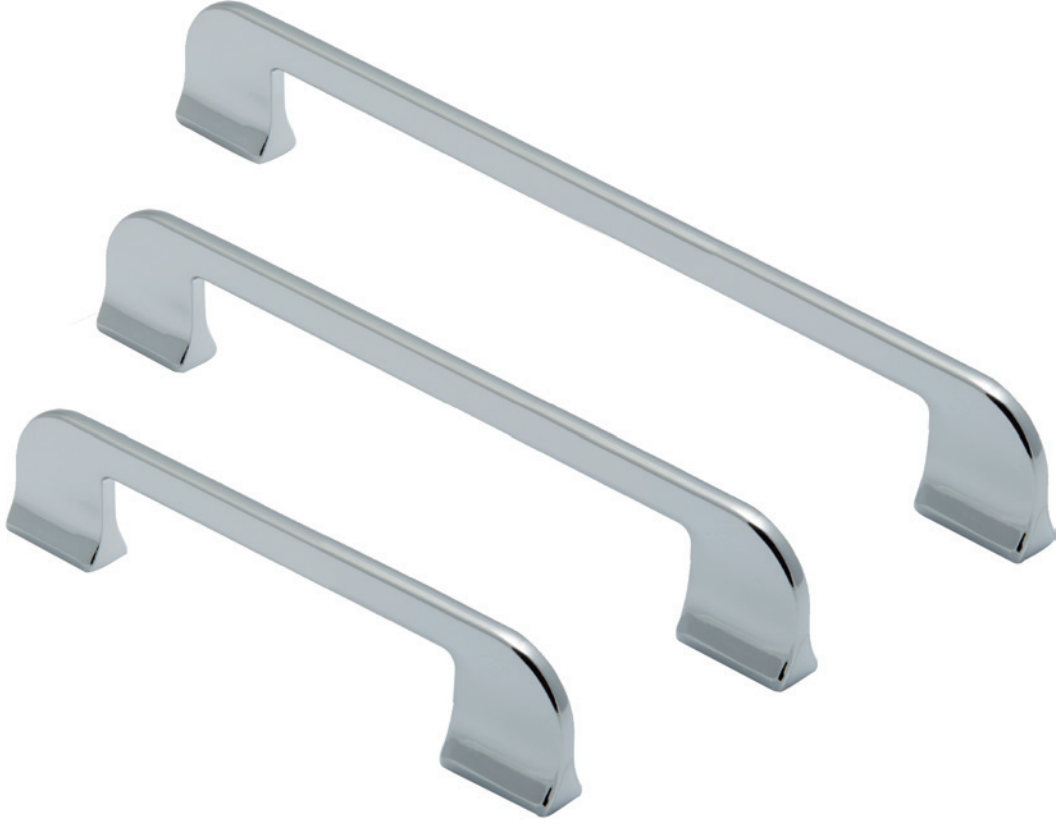
591 Serisi / Series**Krom**
Chrome**Saten**
Satin Nickel**Antik Bronz**
Antique Bronze**Altın**
Brass**Siyah**
Black

Ölçüler:

160	333841	333842	333843	333844	333845
224	333846	333847	333848	333849	333850
320	333851	333852	333853	333854	333855

TEKNİK DETAYLAR / Details

> Basıncılı Zamak Metal

348 Serisi / Series

Ölçüler:	Krom Chrome	Saten Satin Nickel	Siyah Black
64	335425	335434	335431
128	335426	335436	335433
192	335427	335435	335432



TEKNİK DETAYLAR / Details

> Basıncılı Zamak Metal, Alüminyum

349 Serisi / Series

Ölçüler:	Saten Satin Nickel	Siyah Black	Antik Bronz Antique Bronze
64	335440	335443	335446
128	335441	335444	335447
192	335442	335445	335448



TEKNİK DETAYLAR / Details

> Basıncılı Zamak Metal, Alüminyum

350 Serisi / Series

Ölçüler:	Saten Satin Nickel	Siyah Black	Altın Brass
160	335455	335452	335449
224	335456	335453	335450
320	335457	335454	335451



TEKNİK DETAYLAR / Details

> Basıncılı Zamak Metal, Alüminyum

351 Serisi / Series

Ölçüler:	Saten Satin Nickel	Antik Bronz Antique Bronze	Altın Brass
160	335464	335470	335461
224	335465	335471	335462
320	335466	335472	335463



TEKNİK DETAYLAR / Details

> Basıncılı Zamak Metal, Alüminyum

390 Serisi / Series



	Krom Chrome	Saten Satin Nickel	Siyah Black
Ölçüler:			
160	333885	333886	333887
224	333888	333889	333890

TEKNİK DETAYLAR / Details

> Basıncılı Zamak Metal

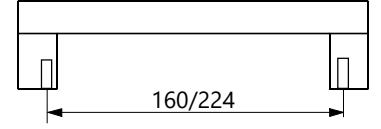

901 Serisi / Series



	Krom Chrome	Saten Satin Nickel	Altın Brass
Ölçüler:			
128	089569	087924	082096
192	089568	087925	088631

TEKNİK DETAYLAR / Details

> Basıncılı Zamak Metal

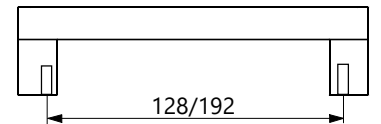

751 Serisi / Series

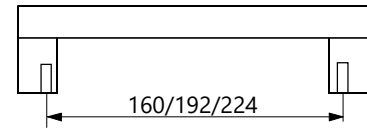

	Krom Chrome	Saten Satin Nickel	Antik Bronz Antique Bronze	Altın Brass	Siyah Black
Ölçüler:					
Tekli	333895	333896	333897	333898	333899
160	333900	333901	333902	333903	333904
192	333905	333906	333907	333908	333909
224	333910	333911	333912	333913	333914

TEKNİK DETAYLAR / Details

> Basıncılı Zamak Metal

144 Serisi / Series

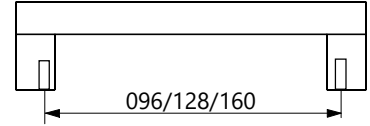

Ölçüler:	Krom Chrome	Saten Satin Nickel	Antik Bronz Antique Bronze	Altın Brass	Siyah Black
096	334233	334234	334235	334236	334237
128	334238	334239	334240	334241	334242
160	334243	334244	334245	334246	334247

TEKNİK DETAYLAR / Details

> Basıncılı Zamak Metal

149 Serisi / Series

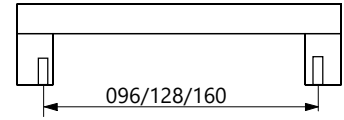

Ölçüler:	Krom Chrome	Saten Satin Nickel	Antik Bronz Antique Bronze	Altın Brass	Siyah Black
096	334218	334219	334220	334221	334222
128	334223	334224	334225	334226	334227
160	334228	334229	334230	334231	334232

TEKNİK DETAYLAR / Details

> Basıncılı Zamak Metal

835 Serisi / Series

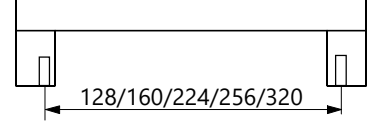

Ölçüler:	Krom Chrome	Saten Satin Nickel	Antik Bronz Antique Bronze	Siyah Black
128	333925	333926	333927	333931
256	333928	333929	3338330	333932

TEKNİK DETAYLAR / Details

> Basıncılı Zamak Metal

1133 Serisi / Series



Ölçüler:	Antik Bronz Antique Bronze	Mat Altın Matt Brass
032	328599	328602
128	328600	328601

TEKNİK DETAYLAR / Details

> Basıncılı Zamak Metal

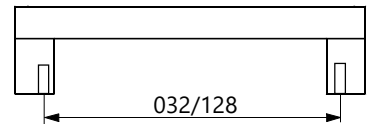



140 Serisi / Series

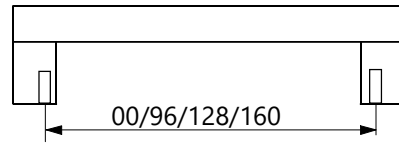

Krom
Chrome



Saten
Satin Nickel



Antik Bronz
Antique Bronze



Altın
Brass



Siyah
Black



Tekli	333934	333935	333936	333937	333938
96	333939	333940	333941	333942	333943
128	333944	333945	333946	333947	333948
160	333949	333950	333951	333952	333953

TEKNİK DETAYLAR / Details

> Basıncılı Zamak Metal

138 Serisi / Series

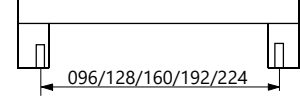

Ölçüler:	Krom Chrome	Saten Satin Nickel	Antik Bronz Antique Bronze	Altın Brass	Siyah Black
96	333954	333955	333956	333957	333958
128	333959	333960	333961	333962	333963
160	333964	333965	333966	333967	333968

TEKNİK DETAYLAR / Details

> Basıncılı Zamak Metal

132 Serisi / Series

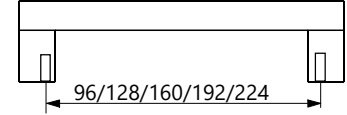

Ölçüler:	Krom Chrome	Saten Satin Nickel	Antik Bronz Antique Bronze	Altın Brass	Siyah Black
96	333969	333970	333971	333972	333973
128	333974	333975	333976	333977	333978
160	333979	333980	333981	333982	333983

TEKNİK DETAYLAR / Details

> Basıncılı Zamak Metal

760 Serisi / Series

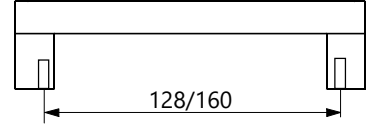

Krom
Chrome

Saten
Satin Nickel

Antik Bronz
Antique Bronze

Altın
Brass

Siyah
Black

Ölçüler:

Tekli	334199	334200	334201	334202	334203
128	334204	334205	334206	334207	334208
160	334209	334210	334211	334212	334213

TEKNİK DETAYLAR / Details

> Basıncılı Zamak Metal

549 Serisi / Series

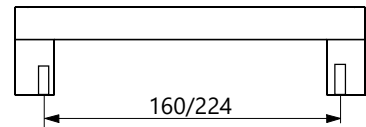

Krom
Chrome

Saten
Satin Nickel

Antik Bronz
Antique Bronze

Altın
Brass

Siyah
Black

Ölçüler:

160	334586	334587	334588	334589	334590
224	334591	334592	334593	334594	334595

TEKNİK DETAYLAR / Details

> Basıncılı Zamak Metal

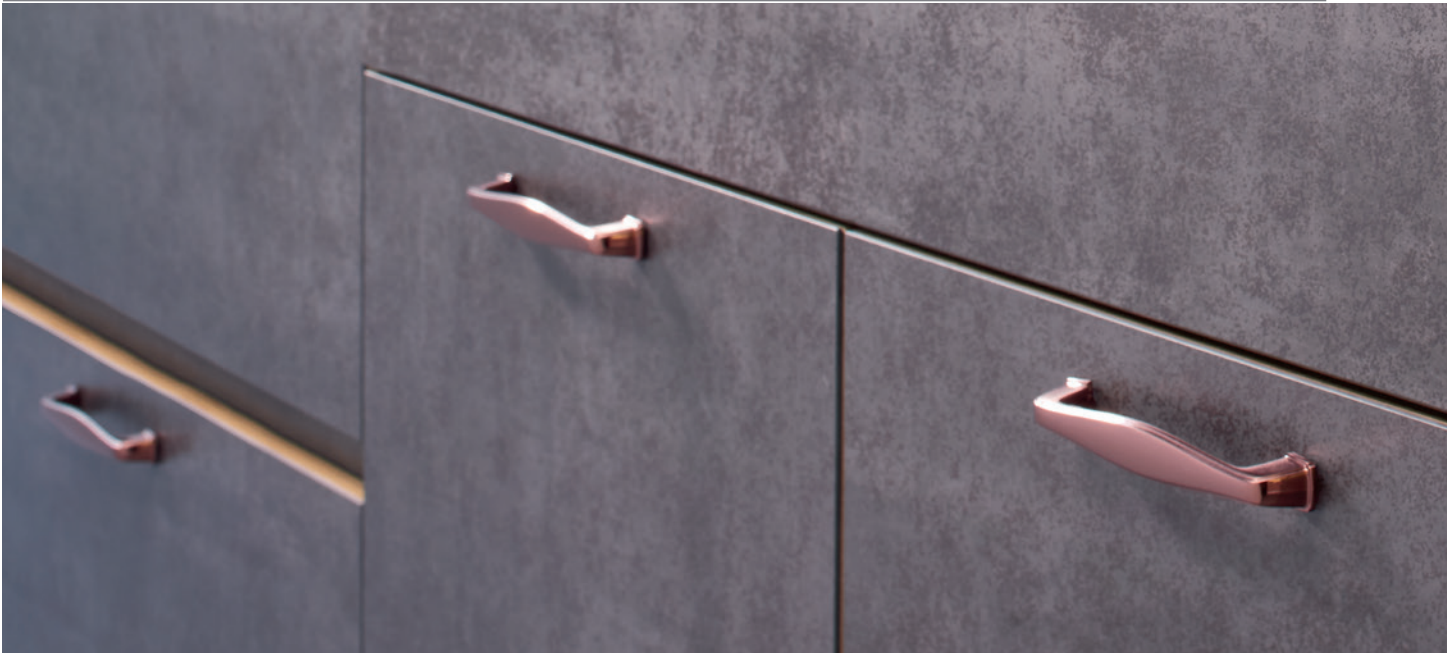

351 Serisi / Series

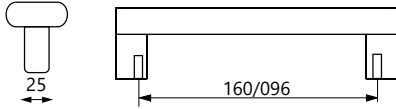

Ölçüler:	Krom Chrome	Saten Satin Nickel	Altın Brass	Siyah Black	Antik Bronze Antique Bronze
Tekli	315694	315695	315696	315697	315698
096	315699	315700	315702	315703	315775
160	315703	315704	315705	315706	315776

TEKNİK DETAYLAR / Details

> Alüminyum

326 Serisi / Series



Ölçüler:	Krom Chrome	Mat Altın Matte Brass	Antik Antique
096	073561	073562	073017
160	073563	073564	073016

TEKNİK DETAYLAR / Details

> Basıncılı Zamak Metal

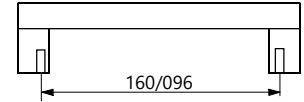

340 Serisi / Series



Ölçüler:	Antik Antique	Bakır Copper
128	333995	334752
192	333996	334753

TEKNİK DETAYLAR / Details

> Basıncılı Zamak Metal

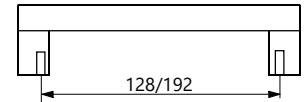

329 Serisi / Series



Ölçüler:	Antik Antique	Mat Altın Matte Brass
128	334007	334008
192	334009	334010

TEKNİK DETAYLAR / Details

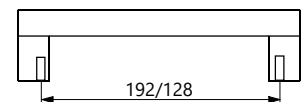

> Basıncılı Zamak Metal



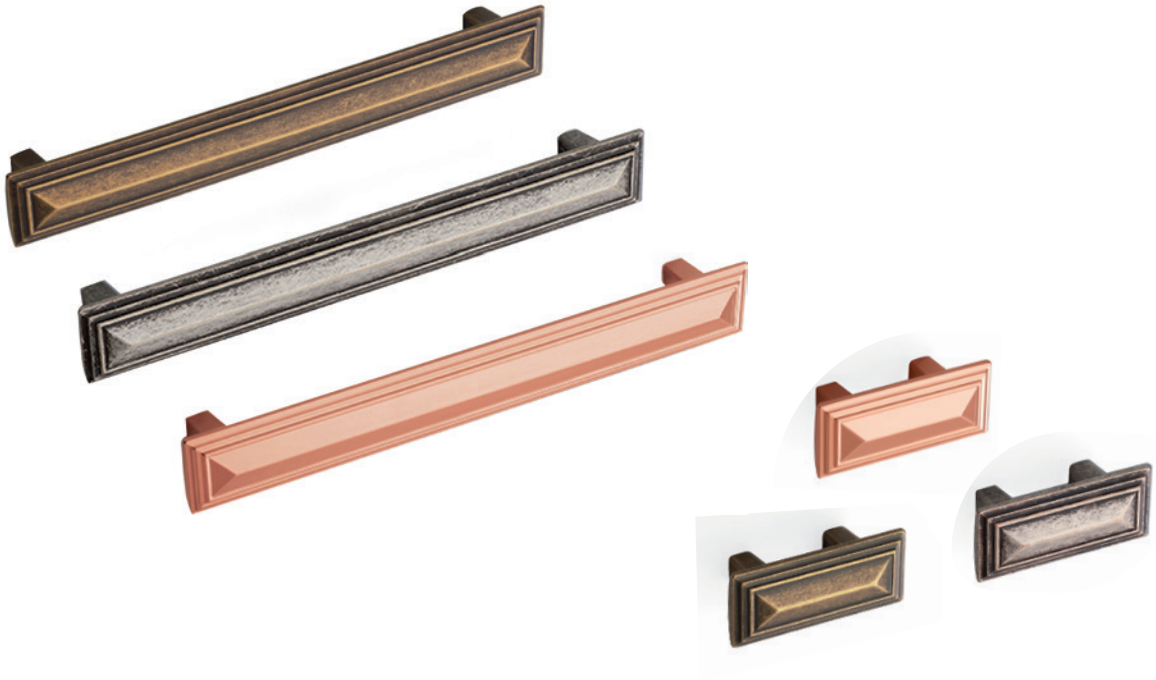

354 Serisi / Series



	Antik Bronz Antique Bronze	Altın Brass	Demir Iron
Öçüler:			
032	334013	334014	334015
096	334016	334017	334018
160	334019	334020	334021

TEKNİK DETAYLAR / Details

> Alüminyum

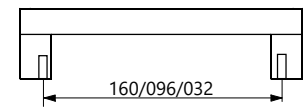

752 Serisi / Series

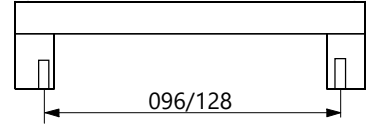

Krom
Chrome

Saten
Satin Nickel

Antik Bronz
Antique Bronze

Altın
Brass

Siyah
Black

Ölçüler:



Tekli	334022	334023	334024	334025	334026
096	334027	334028	334029	334030	334031
160	334032	334033	334034	334035	334036

TEKNİK DETAYLAR / Details

> Basıncılı Zamak Metal

141 Serisi / Series

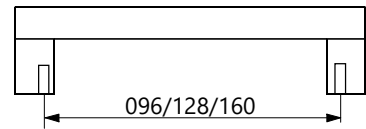

Krom
Chrome

Saten
Satin Nickel

Antik Bronz
Antique Bronze

Altın
Brass

Siyah
Black

Ölçüler:



096	334184	334185	334186	334187	334188
128	334189	334190	334191	334192	334193
160	334194	334195	334196	334197	334198

TEKNİK DETAYLAR / Details

> Basıncılı Zamak Metal

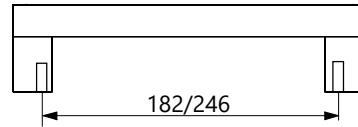

548 Serisi / Series

Antik Sarı
Antique Brass

333519

333523

Mat Siyah
Matte Black

333524

333525

TEKNİK DETAYLAR / Details

> Basıncılı Zamak Metal

54312 Serisi / Series



Antik San
Antique Brass



333511

Mat Siyah
Matte Black



333512

TEKNİK DETAYLAR / Details

> Basınçlı Zamak Metal

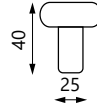

54922 Serisi / Series



Antik San
Antique Brass



333513

Siyah
Black



333514

TEKNİK DETAYLAR / Details

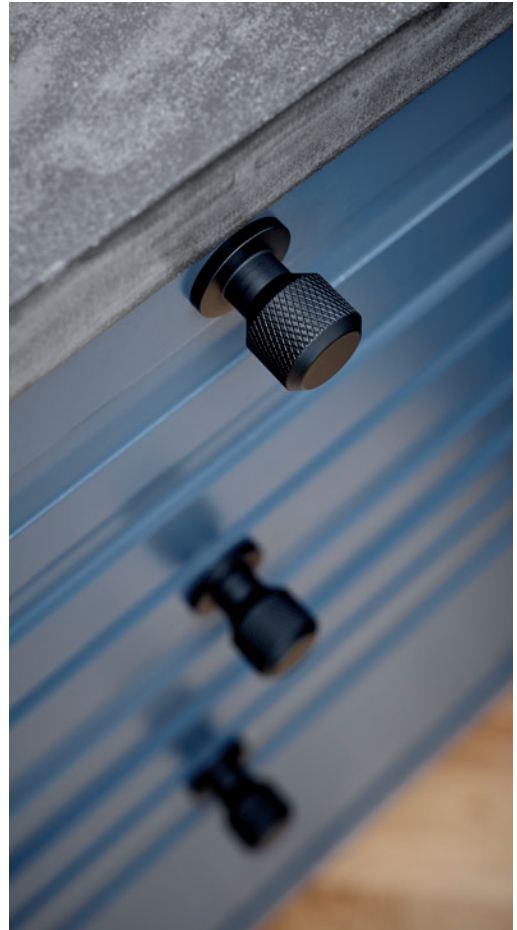
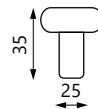

> Basınçlı Zamak Metal

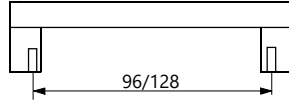
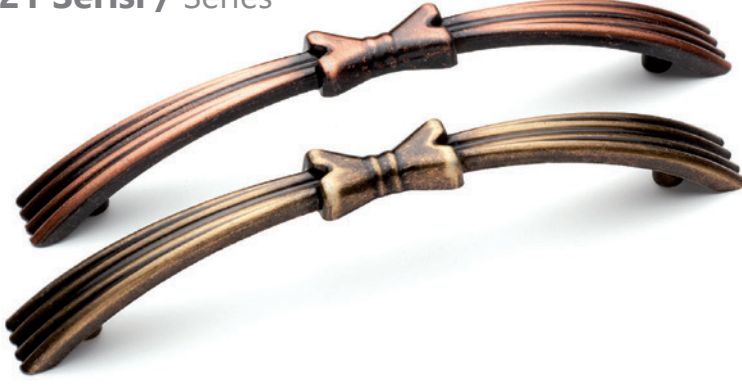

Mobilya Kulpları Furniture Handles

721 Serisi / Series





	Antik San Antique Brass	Antik Bakır Antique Copper
Ölçüler:		
096	334046	334048
128	334047	334049

TEKNİK DETAYLAR / Details

> Basıncılı Zamak Metal

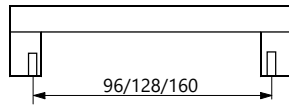
799 Serisi / Series







	Antik San Antique Brass	Antik Bakır Antique Copper
Ölçüler:		
096	334050	334053
128	334051	334054
160	334052	334055

TEKNİK DETAYLAR / Details

> Basıncılı Zamak Metal

259 Serisi / Series



Krom Chrome	Altın Brass	Antik San Antique Brass	Antik Bakır Antique Copper
			
334056	334057	334058	334059

TEKNİK DETAYLAR / Details

> Basıncılı Zamak Metal

771 Serisi / Series

Ölçüler:	Antik San Antique Brass	Antik Bakır Antique Copper
Tekdi	334067	334068
096	334069	334070
128	334071	334072

TEKNİK DETAYLAR / Details

> Basınçlı Zamak Metal

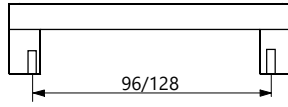
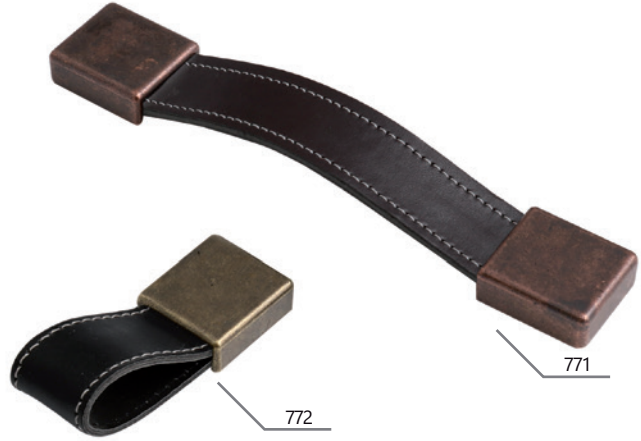

720 Serisi / Series

Ölçüler:	Antik San Antique Brass	Antik Bakır Antique Copper
096	334074	334076
128	334075	334077

TEKNİK DETAYLAR / Details

> Basınçlı Zamak Metal

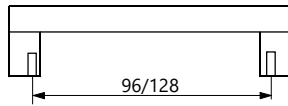

725 Serisi / Series

Ölçüler:	Antik San Antique Brass	Antik Bakır Antique Copper
Tekdi	334082	334083
096	334078	334079
128	334080	334081
160	334085	334086

TEKNİK DETAYLAR / Details

> Basınçlı Zamak Metal

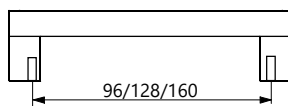

315 Serisi / Series

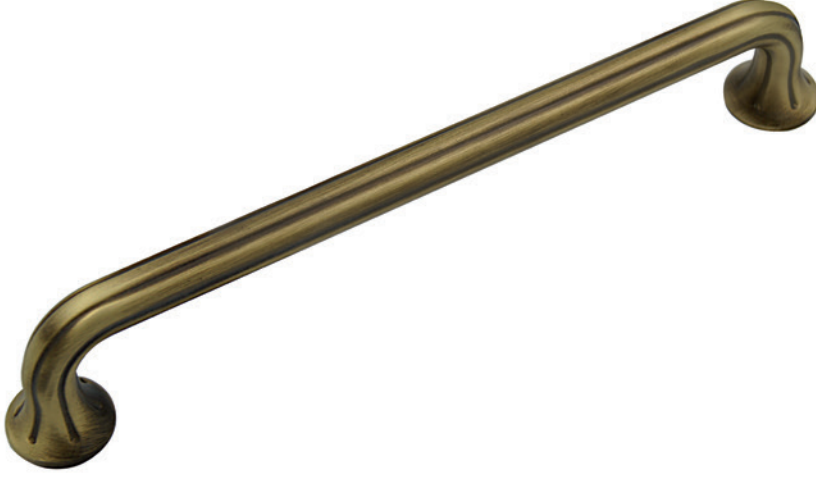

Mat Sarı
Matte Brass

Antik Bronz
Antique Bronze

Ölçüler:

	Mat Sarı Matte Brass	Antik Bronz Antique Bronze
192	335548	335546
320	335551	335549

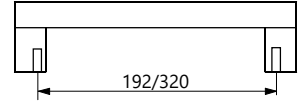

TEKNİK DETAYLAR / Details

> Basıncılı Zamak Metal

311 Serisi / Series

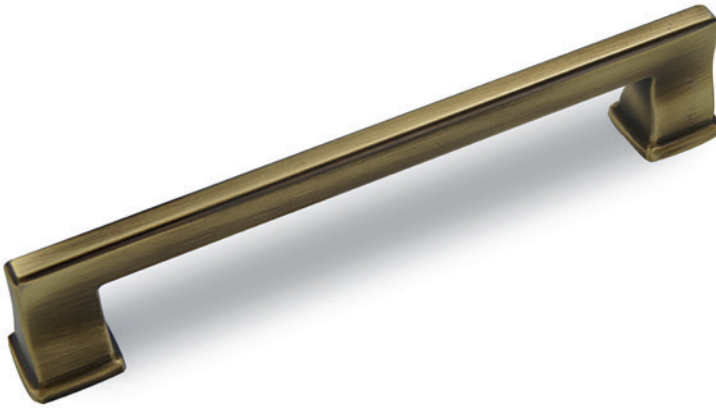

Siyah
Black

Antik Bronz
Antique Bronze

Ölçüler:

	Siyah Black	Antik Bronz Antique Bronze
160	327277	327279
224	327278	327280

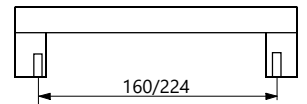

TEKNİK DETAYLAR / Details

> Basıncılı Zamak Metal

352 Serisi / Series



Antik San
Antique Brass

Ölçüler:



032	334096
096	334097
128	334098

TEKNİK DETAYLAR / Details

> Basınçlı Zamak Metal

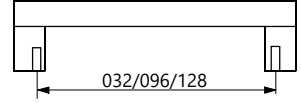

332 Serisi / Series



Mat Altın Beyaz
Matte Brass White

Antik Beyaz
Antique White

Ölçüler:



096	081901	088867
160	082415	088868

TEKNİK DETAYLAR / Details

> Basınçlı Zamak Metal

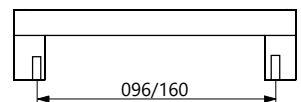

344 Serisi / Series



Antik Demir
Antique Iron



Antik Bronz
Antique Bronze



Ölçüler:

Ölçü	Antik Demir / Antique Iron	Antik Bronz / Antique Bronze
96	333969	333970
128	333974	333975
160	333979	333980

TEKNİK DETAYLAR / Details

> Basınçlı Zamak Metal, Alüminyum

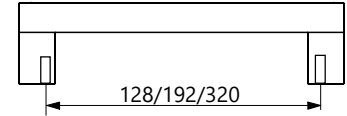

343 Serisi / Series



Krom
Chrome



Antik Bronz
Antique Bronze



Siyah
Black



Ölçüler:

Ölçü	Krom / Chrome	Antik Bronz / Antique Bronze	Siyah / Black
96	335663	321369	321375
128	327697	321370	321376
160	327696	321371	321377

TEKNİK DETAYLAR / Details

> Basınçlı Zamak Metal, Alüminyum

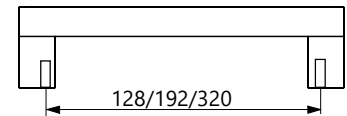

369 Serisi / Series



Antik San
Antique Brass

Ölçüler:

Tekli	334129
128	334130
160	334131

TEKNİK DETAYLAR / Details

> Basıncılı Zamak Metal

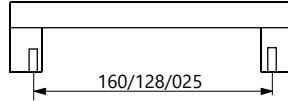

368 Serisi / Series



Antik San
Antique Brass

Ölçüler:

Tekli	334132
096	334133

TEKNİK DETAYLAR / Details

> Basıncılı Zamak Metal

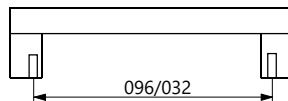



492 Serisi / Series

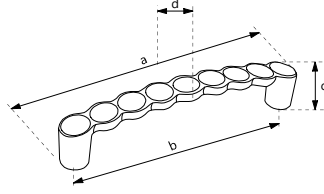
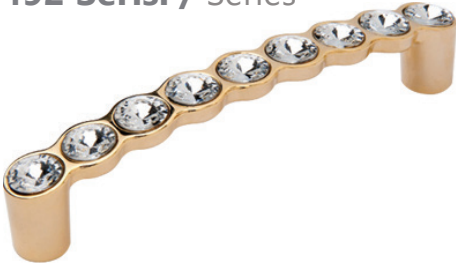

Ölçüler:	Krom Chrome	Altın Brass	İnoks Inox
096	054993	070221	054994
128	060966	073301	073302

TEKNİK DETAYLAR / Details

> Basıncılı Zamak Metal

92 Serisi / Series

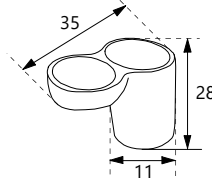

Ölçüler:	Krom Chrome	Altın Brass	İnoks Inox
	066027	073303	073304

TEKNİK DETAYLAR / Details

> Basıncılı Zamak Metal

491 Serisi / Series

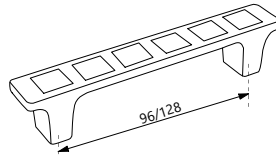

Ölçüler:	Krom Chrome	Altın Brass	İnoks Inox
096	055167	073306	073308
128	073305	073307	073309

TEKNİK DETAYLAR / Details

> Basıncılı Zamak Metal

91 Serisi / Series

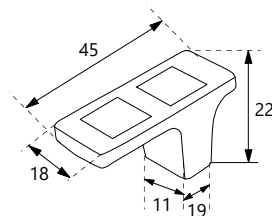

Ölçüler:	Krom Chrome	Altın Brass	Saten Satin
	066029	073310	073311

TEKNİK DETAYLAR / Details

> Basıncılı Zamak Metal

420 Serisi / Series



Ölçüler:	Krom Chrome	Altın Brass	Antik Antique	Antik Bakır Antique Copper
160	334135	334136	334137	334138

TEKNİK DETAYLAR / Details

> Basıncılı Zamak Metal

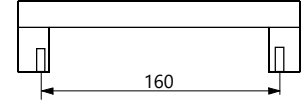

404 Serisi / Series



Ölçüler:	Krom Chrome	Altın Brass	Antik Sarı Antique Brass	Antik Bakır Antique Copper
160	334139	334140	334141	334142

TEKNİK DETAYLAR / Details

> Basıncılı Zamak Metal

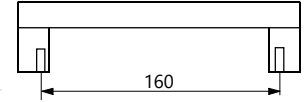

240 Serisi / Series



Ölçüler:	Krom Chrome	Altın Brass	Antik Sarı Antique Brass	Antik Bakır Antique Copper
160	334143	334144	334145	334146

TEKNİK DETAYLAR / Details

> Basıncılı Zamak Metal

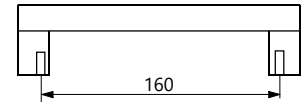

239 Serisi / Series



Ölçüler:	Krom Chrome	Altın Brass	Antik Antique	Antik Bakır Antique Copper
064	334147	334148	334149	334150
160	334151	334152	334153	334154

TEKNİK DETAYLAR / Details

> Basıncılı Zamak Metal

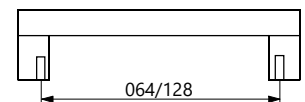

278 Serisi / Series



Ölçüler:	Krom Chrome	Altın Brass	Antik Antique
Tekli	334747	334748	334749
160	333856	333857	333858
192	333859	333860	333861

TEKNİK DETAYLAR / Details

> Basıncılı Zamak Metal

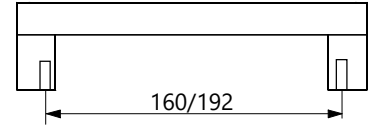
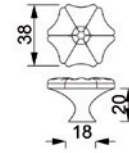

276 Serisi / Series



Ölçüler:	Krom Chrome	Altın Brass	Antik Antique
Tekli	333882	333883	333884
096	333862	333863	333864
160	333865	333866	333867

TEKNİK DETAYLAR / Details

> Basıncılı Zamak Metal

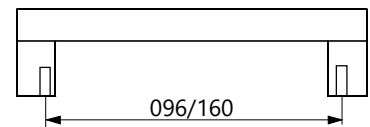
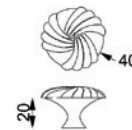



9128 Serisi / Series

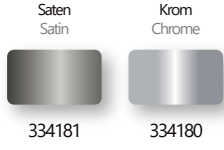

TEKNİK DETAYLAR / Details

> Basıncılı Zamak Metal

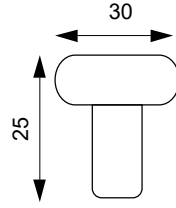

9162 Serisi / Series



TEKNİK DETAYLAR / Details

> Basıncılı Zamak Metal



901 Serisi / Series

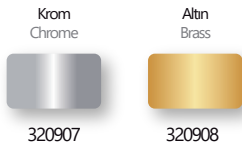

TEKNİK DETAYLAR / Details

> Basıncılı Zamak Metal

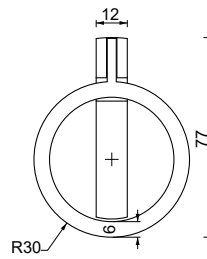

51 Serisi / Series

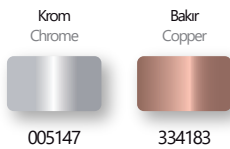

TEKNİK DETAYLAR / Details

> Basıncılı Zamak Metal

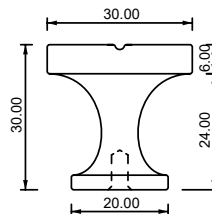

9161 Serisi / Series

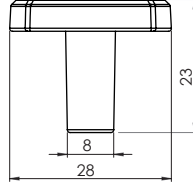

Siyah
Black



334177

TEKNİK DETAYLAR / Details

> Basıncı Zamak Metal

39 Serisi / Series

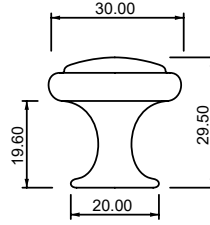

Saten
Satin



327702

Krom
Chrome



327701

TEKNİK DETAYLAR / Details

> Basıncı Zamak Metal

673 Serisi / Series

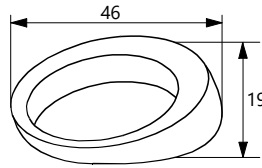

Mat Krom
Matte Chrome



053348

Saten
Satin Nickel



053350

TEKNİK DETAYLAR / Details

> Basıncı Zamak Metal

904 Serisi / Series

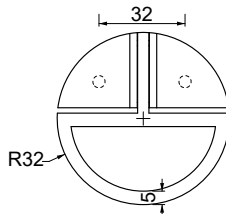
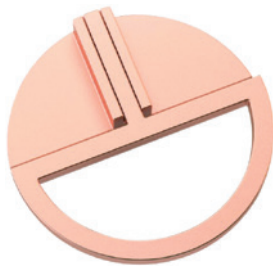

Bakır
Copper



334179

TEKNİK DETAYLAR / Details

> Basıncı Zamak Metal

9129 Serisi / Series

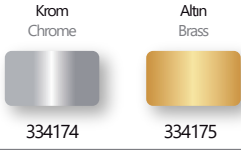

TEKNİK DETAYLAR / Details

> Basıncılı Zamak Metal

9159 Serisi / Series

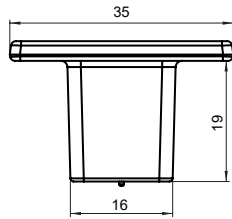

TEKNİK DETAYLAR / Details

> Basıncılı Zamak Metal

30 Serisi / Series

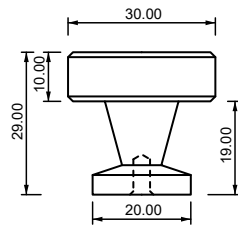
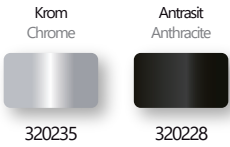

TEKNİK DETAYLAR / Details

> Basıncılı Zamak Metal

371 Serisi / Series

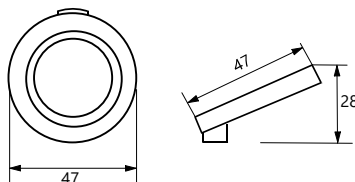
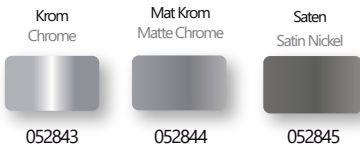

TEKNİK DETAYLAR / Details

> Basıncılı Zamak Metal

903 Serisi / Series

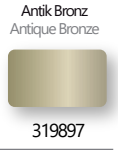
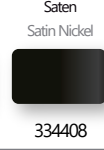
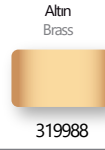
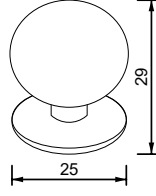

TEKNİK DETAYLAR / Details

> Basıncılı Zamak Metal

9130 Serisi / Series



TEKNİK DETAYLAR / Details

> Basıncılı Zamak Metal

31 Serisi / Series

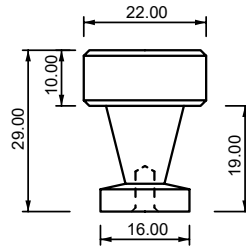

TEKNİK DETAYLAR / Details

> Basıncılı Zamak Metal

28 Serisi / Series

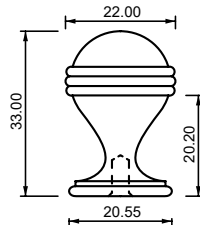

TEKNİK DETAYLAR / Details

> Basıncılı Zamak Metal

260 Serisi / Series

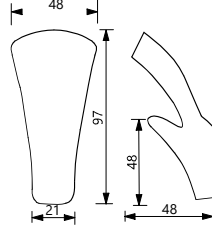
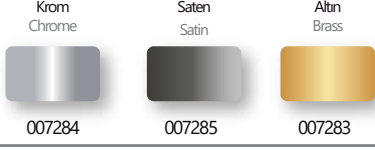

TEKNİK DETAYLAR / Details

> Basıncılı Zamak Metal

270 Serisi / Series

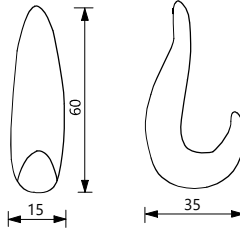
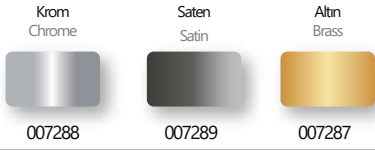

TEKNİK DETAYLAR / Details

> Basıncılı Zamak Metal

500 Serisi / Series

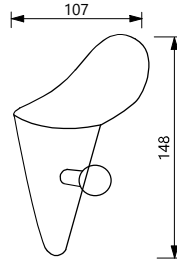
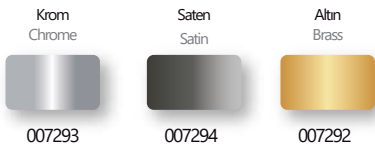

TEKNİK DETAYLAR / Details

> Basıncılı Zamak Metal

730 Serisi

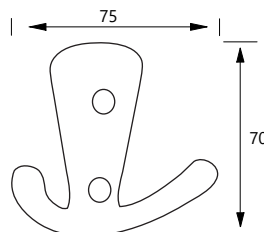

TEKNİK DETAYLAR / Details

> Basıncılı Zamak Metal

Mobilya Kulpları

Furniture Handles

78 Serisi / Series

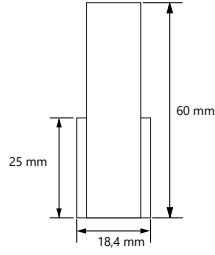

TEKNİK DETAYLAR / Details

> Alüminyum

320-D Serisi / Series

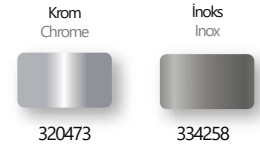
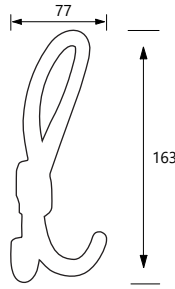

TEKNİK DETAYLAR / Details

> Basıncılı Zamak Metal

320-K Serisi / Series

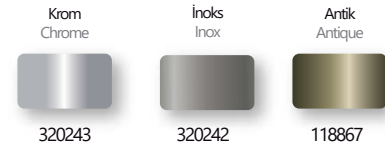
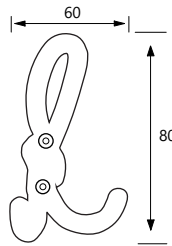

TEKNİK DETAYLAR / Details

> Basıncılı Zamak Metal

320-DA Serisi / Series

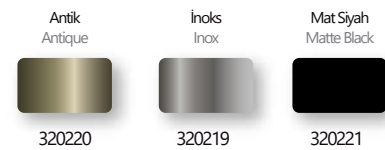
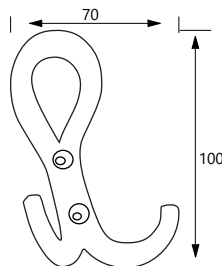

TEKNİK DETAYLAR / Details

> Basıncılı Zamak Metal



2022 Serisi / Series



TEKNİK DETAYLAR / Details

> Alüminyum

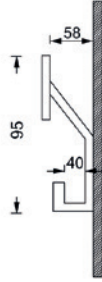

713 Serisi / Series



TEKNİK DETAYLAR / Details

> Basıncılı Zamak Metal

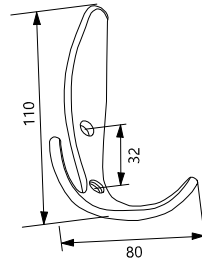

720 Serisi / Series

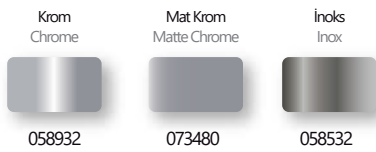

TEKNİK DETAYLAR / Details

> Basıncılı Zamak Metal

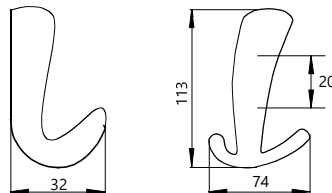

Mobilya Kulpları

Furniture Handles

RF-U50 Serisi / Series



Rotating and Swing Hook

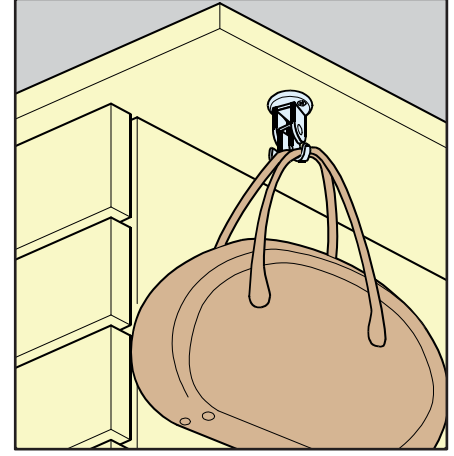
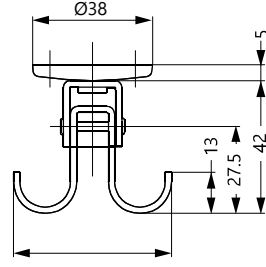
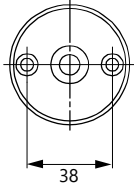

Paslanmaz
Stainless



071444

TEKNİK DETAYLAR / Details

> Paslanmaz çelik

DA-12 Serisi / Series

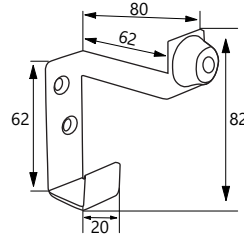

Paslanmaz
Stainless



211139

TEKNİK DETAYLAR / Details

> Paslanmaz çelik

SH-13 Serisi / Series

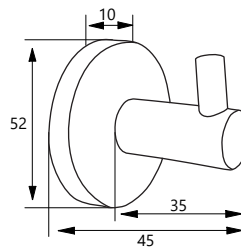
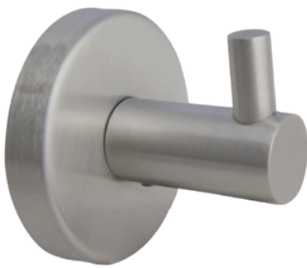

Paslanmaz
Stainless



320402

TEKNİK DETAYLAR / Details

> Paslanmaz çelik



146 Serisi / Series

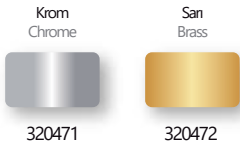

TEKNİK DETAYLAR / Details

> Basınçlı Zamak Metal

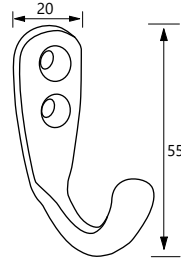

147 Serisi / Series

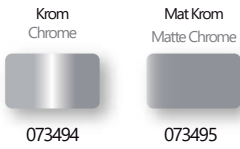

TEKNİK DETAYLAR / Details

> Basınçlı Zamak Metal

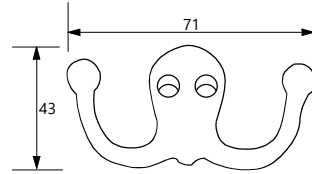

111 Serisi / Series

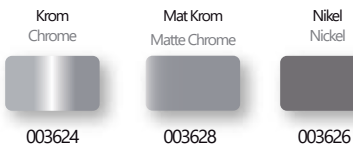

TEKNİK DETAYLAR / Details

> Basınçlı Zamak Metal

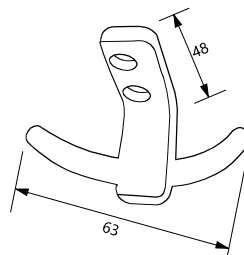

Mobilya Kulpları

Furniture Handles

400 Serisi / Series

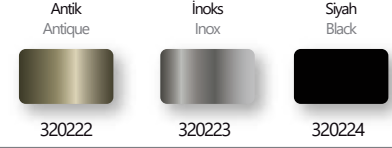
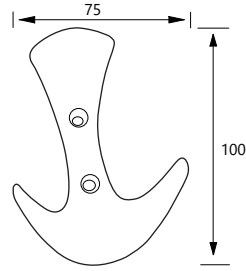

TEKNİK DETAYLAR / Details

> Basıncılı Zamak Metal

725 Serisi / Series

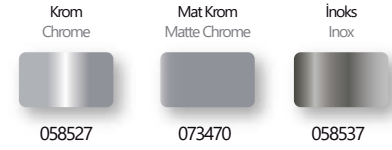
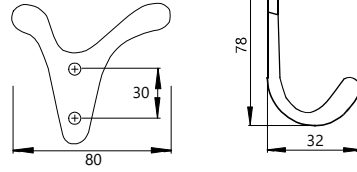

TEKNİK DETAYLAR / Details

> Basıncılı Zamak Metal

358 Serisi / Series

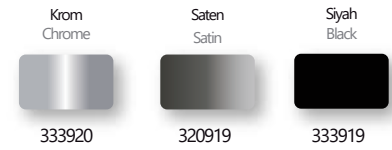
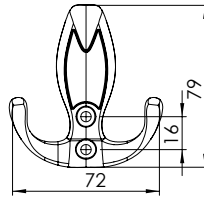

TEKNİK DETAYLAR / Details

> Basıncılı Zamak Metal

2023 Serisi / Series

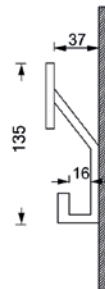

TEKNİK DETAYLAR / Details

> Alüminyum



491032 Serisi / Series

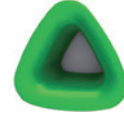
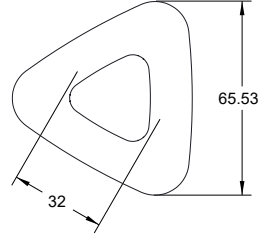
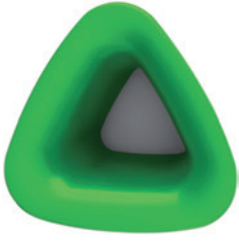

073843

TEKNİK DETAYLAR / Details

> Antibakteriyel Özel Plastikten Üretilmiştir

490032 Serisi / Series

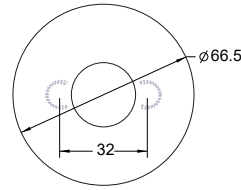

334259

TEKNİK DETAYLAR / Details

> Antibakteriyel Özel Plastikten Üretilmiştir

489032 Serisi / Series

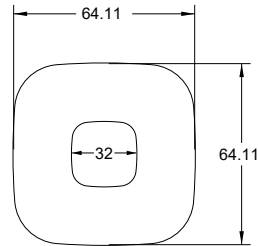

334281

TEKNİK DETAYLAR / Details

> Antibakteriyel Özel Plastikten Üretilmiştir

488025 Serisi / Series

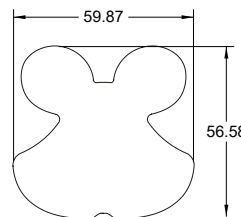

334282

TEKNİK DETAYLAR / Details

> Antibakteriyel Özel Plastikten Üretilmiştir

487025 Serisi / Series



334283

TEKNİK DETAYLAR / Details

> Antibakteriyel Özel Plastikten Üretilmiştir

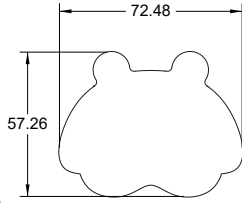

485025 Serisi / Series



073853

TEKNİK DETAYLAR / Details

> Antibakteriyel Özel Plastikten Üretilmiştir

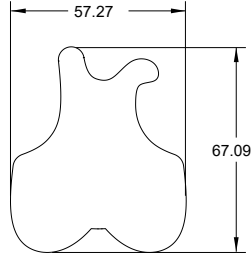

484025 Serisi / Series



073852

TEKNİK DETAYLAR / Details

> Antibakteriyel Özel Plastikten Üretilmiştir

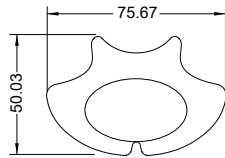

448025 Serisi / Series



334284

TEKNİK DETAYLAR / Details

> Antibakteriyel Özel Plastikten Üretilmiştir

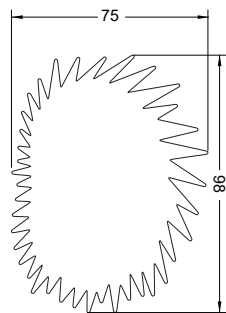

KARE KONSEPT ALUMİNYUM

CONCEPT
KARE

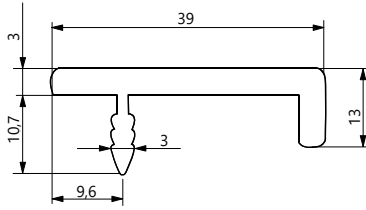
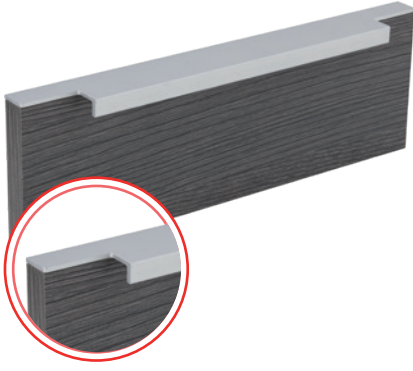

Entegre Kulp / Integrated Furniture Handle
101 Seri



Ölçü Boy (mm)	Renk	
	(06) Krom	(02) Şampanya
197 mm	070641	081292
247 mm	070642	081293
297 mm	070643	081294
347 mm	070644	081295
397 mm	070645	081296
447 mm	070646	081297
497 mm	070647	081298
547 mm	070648	081299
597 mm	070649	081300
697 mm	070650	081302
797 mm	070651	081304
897 mm	070652	081306
1000 mm	060110	081307

TEKNİK DETAYLAR / Details

Malzeme : Alüminyum
Montaj : Kanala Geçme
Renk : (01) Eloksal, (02) Şampanya, (04) Siyah,
(05) Kimyasal, (06) Krom, (07) Sarı,
(08) Mavi, (09) Kırmızı

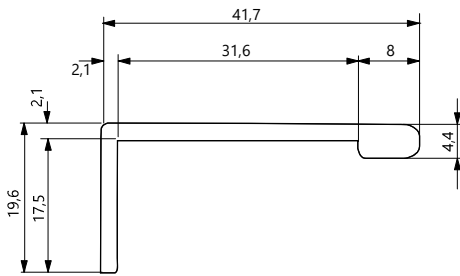
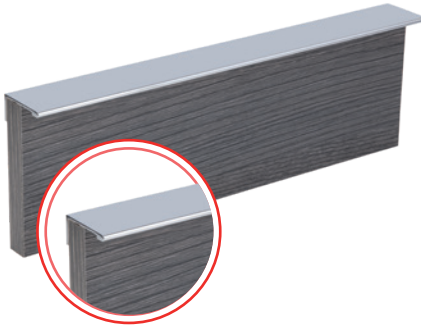

Entegre Kulp / Integrated Furniture Handle
102 Seri



Ölçü Boy (mm)	Renk	
	(06) Krom	(02) Şampanya
197 mm	081314	081326
247 mm	081315	081327
297 mm	081316	081328
347 mm	081317	081332
397 mm	081318	081333
447 mm	072218	081334
497 mm	081319	081335
547 mm	081320	081336
597 mm	081321	081337
697 mm	081322	081338
797 mm	081323	081339
897 mm	081324	081340
1000 mm	081325	081341

TEKNİK DETAYLAR / Details

Malzeme : Alüminyum
Montaj : Kanala Geçme
Renk : (01) Eloksal, (02) Şampanya, (04) Siyah,
(05) Kimyasal, (06) Krom, (07) Sarı,
(08) Mavi, (09) Kırmızı



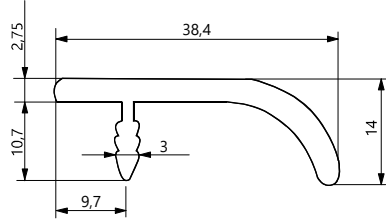
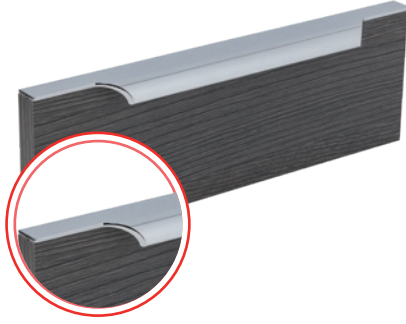

Entegre Kulp / Integrated Furniture Handle
103 Seri



Ölçü Boy (mm)	Renk	
	(06) Krom	(02) Şampanya
197 mm	081352	081345
247 mm	081351	081344
297 mm	076661	081343
347 mm	073865	081342
397 mm	073866	076216
447 mm	076149	081349
497 mm	081353	076214
547 mm	081354	081350
597 mm	081355	076217
697 mm	073867	076218
797 mm	081356	081346
897 mm	081357	081347
1000 mm	081358	081348

TEKNİK DETAYLAR / Details

Malzeme : Alüminyum
Montaj : Kanala Geçme
Renk : (01) Elokstal, (02) Şampanya, (04) Siyah,
(05) Kimyasal, (06) Krom, (07) Sarı,
(08) Mavi, (09) Kırmızı

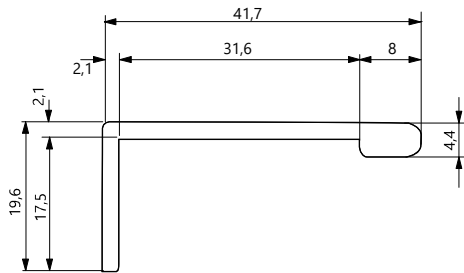
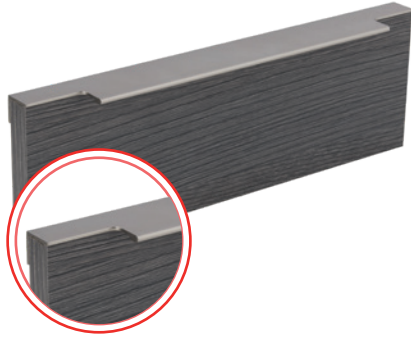
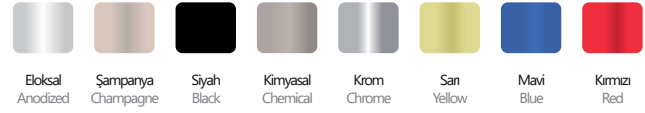

Entegre Kulp / Integrated Furniture Handle
104 Seri



Ölçü Boy (mm)	Renk	
	(06) Krom	(02) Şampanya
197 mm	081360	081373
247 mm	081361	081374
297 mm	081362	081375
347 mm	081363	081376
397 mm	081364	081377
447 mm	081365	081378
497 mm	081366	081379
547 mm	081367	081380
597 mm	081368	081381
697 mm	081369	081382
797 mm	081370	081383
897 mm	081371	081384
1000 mm	081372	081385

TEKNİK DETAYLAR / Details

Malzeme : Alüminyum
Montaj : Kanala Geçme
Renk : (01) Elokstal, (02) Şampanya, (04) Siyah,
(05) Kimyasal, (06) Krom, (07) Sarı,
(08) Mavi, (09) Kırmızı



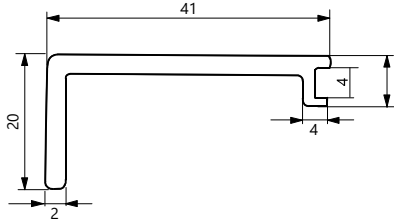
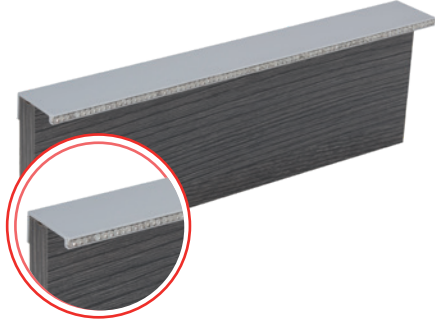

Entegre Kulp / Integrated Furniture Handle
105 Seri



Ölçü Boy (mm)	Renk	
	(06) Krom	(02) Şampanya
197 mm	081386	081398
247 mm	081387	081399
297 mm	081388	081400
347 mm	081252	081401
397 mm	081389	081402
447 mm	081390	081403
497 mm	081391	081404
547 mm	081392	081405
597 mm	081393	081406
697 mm	081394	081407
797 mm	081395	081408
897 mm	081396	081409
1000 mm	081397	081410

TEKNİK DETAYLAR / Details

Malzeme : Alüminyum
Montaj : Kanala Geçme
Renk : (02) Şampanya, (04) Siyah, (05) Kimyasal, (06) Krom, (07) Sarı, (08) Mavi, (09) Kırmızı

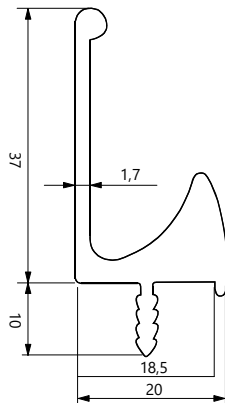
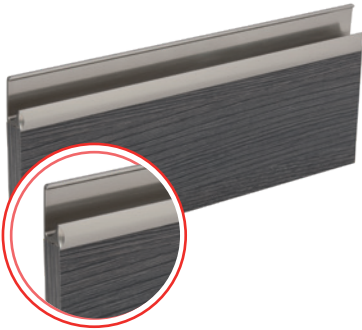

Entegre Kulp / Integrated Furniture Handle
106 Seri



Ölçü Boy (mm)	Renk	
	(05) Kimyasal	(02) Şampanya
197 mm	055346	055347
247 mm	081411	055348
297 mm	081412	055349
347 mm	081413	055350
397 mm	081078	055351
447 mm	057773	055352
497 mm	081414	055353
547 mm	081416	055354
597 mm	076488	055355
697 mm	057772	057771
797 mm	076489	057231
897 mm	076487	055356
1000 mm	081415	055357

TEKNİK DETAYLAR / Details

Malzeme : Alüminyum
Montaj : Kanala Geçme
Renk : (01) Elokسال, (02) Şampanya, (04) Siyah, (05) Kimyasal, (07) Sarı, (08) Mavi, (09) Kırmızı





CONCEPT
KARE

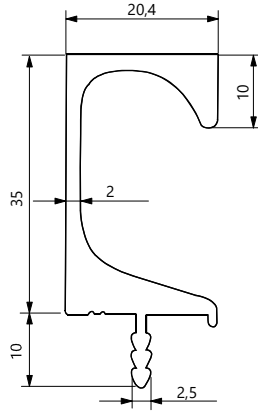
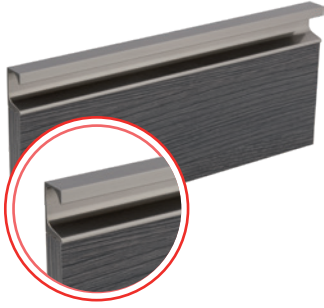

Entegre Kulp / Integrated Furniture Handle
107 Seri



Ölçü Boy (mm)	Renk	
	(05) Kimyasal	(02) Şampanya
197 mm	081427	081417
247 mm	081426	081418
297 mm	081425	081419
347 mm	081424	081420
397 mm	081423	063809
447 mm	072195	063810
497 mm	072196	063819
547 mm	081428	081153
597 mm	072197	070870
697 mm	071610	063817
797 mm	081429	081421
897 mm	081430	070871
1000 mm	081431	081422

TEKNİK DETAYLAR / Details

Malzeme : Alüminyum
Montaj : Kanala Geçme
Renk : (01) Eloksal, (02) Şampanya, (04) Siyah,
(05) Kimyasal, (07) Sarı, (08) Mavi,
(09) Kırmızı

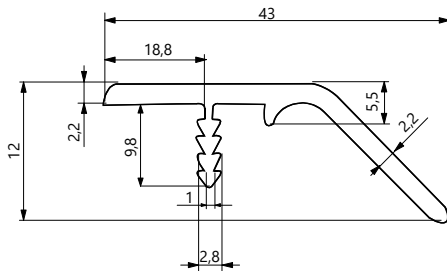
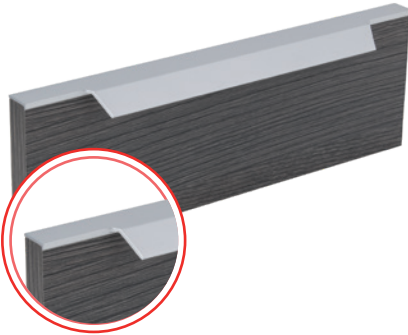

Entegre Kulp / Integrated Furniture Handle
108 Seri



Ölçü Boy (mm)	Renk	
	(05) Kimyasal	(02) Şampanya
197 mm	072345	081434
247 mm	072346	081433
297 mm	072347	081432
347 mm	072348	081097
397 mm	072349	081090
447 mm	072350	081437
497 mm	072351	081091
547 mm	072352	081092
597 mm	072344	081093
697 mm	072353	081094
797 mm	072354	081095
897 mm	072355	081096
1000 mm	081436	081435

TEKNİK DETAYLAR / Details

Malzeme : Alüminyum
Montaj : Kanala Geçme
Renk : (01) Eloksal, (02) Şampanya, (04) Siyah,
(05) Kimyasal, (07) Sarı, (08) Mavi,
(09) Kırmızı



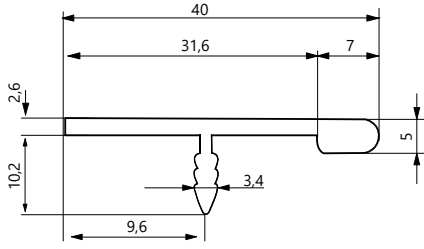
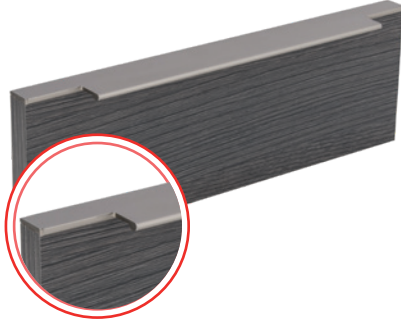

Entegre Kulp / Integrated Furniture Handle
109 Seri

CONCEPT
KARE

Ölçü Boy (mm)	Renk	
	(06) Krom	(02) Şampanya
197 mm	327851	327852
247 mm	327865	327853
297 mm	327866	327854
347 mm	327867	327855
397 mm	327868	327856
447 mm	327869	327857
497 mm	327870	327858
547 mm	327871	327859
597 mm	327872	327860
697 mm	327873	327861
797 mm	327874	327862
897 mm	327875	327863
1000 mm	327876	327864

TEKNİK DETAYLAR / Details

Malzeme : Alüminyum
Montaj : Kanala Geçme
Renk : (01) Eloksal, (02) Şampanya, (04) Siyah,
(05) Kimyasal, (06) Krom, (07) Sarı,
(08) Mavi, (09) Kırmızı

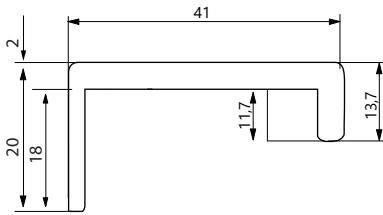
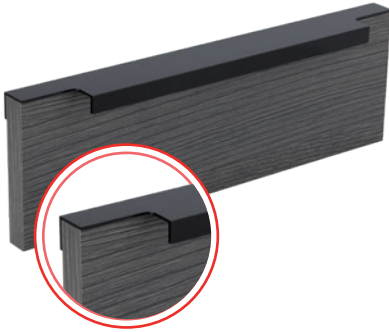

Entegre Kulp / Integrated Furniture Handle
111 Seri

CONCEPT
KARE

Ölçü Boy (mm)	Renk	
	(06) Krom	(02) Şampanya
197 mm	327838	327825
247 mm	327839	327826
297 mm	327840	327827
347 mm	327841	327828
397 mm	327842	327829
447 mm	327843	327830
497 mm	327844	327831
547 mm	327845	327832
597 mm	327846	327833
697 mm	327847	327834
797 mm	327848	327835
897 mm	327849	327836
1000 mm	327850	327837

TEKNİK DETAYLAR / Details

Malzeme : Alüminyum
Montaj : Yüzeğe Montaj
Renk : (01) Eloksal, (02) Şampanya, (04) Siyah,
(05) Kimyasal, (06) Krom, (07) Sarı,
(08) Mavi, (09) Kırmızı

