

Banyo Aksesuarları

Bathroom Accessories

“İyi Fikirler, İyi Çözümler...”

19





Bornozluk
Robe Hook

Kod/Code	Açıklama/Description
118103	Piccolo Bornozluk

TEKNİK DETAYLAR / Details	
Malzeme	: Pirinç
Yüzey Görünüm	: Krom Kaplama
Montaj	: Vidalanarak Montaj

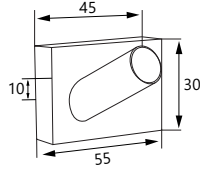

İkili Bornozluk
Double Towel Hook

Kod/Code	Açıklama/Description
118104	Piccolo İkili Bornozluk

TEKNİK DETAYLAR / Details	
Malzeme	: Pirinç
Yüzey Görünüm	: Krom Kaplama
Montaj	: Vidalanarak Montaj

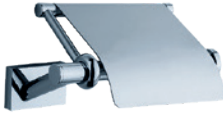
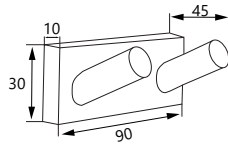

Kapaklı Tuvalet Kağıtlık
Toilet Paper Holder

Kod/Code	Açıklama/Description
118107	Piccolo Tuvalet Kağıtlık Kapaklı

TEKNİK DETAYLAR / Details	
Malzeme	: Pirinç
Yüzey Görünüm	: Krom Kaplama
Montaj	: Vidalanarak Montaj

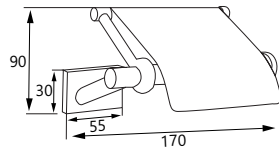

Yuvarlak Havluluk
Towel Holder

Kod/Code	Açıklama/Description
118105	Piccolo Yuvarlak Havluluk

TEKNİK DETAYLAR / Details	
Malzeme	: Pirinç
Yüzey Görünüm	: Krom Kaplama
Montaj	: Vidalanarak Montaj

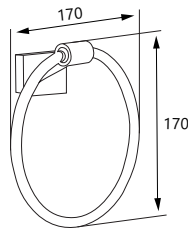

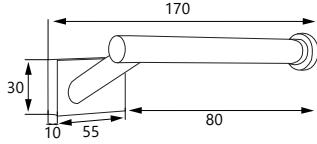

Açık Tuvalet Kağıtlık

Toilet Paper Holder

Kod/Code	Açıklama/Description
119210	Piccolo Açık Tuvalet Kağıtlık

TEKNİK DETAYLAR / Details

Malzeme	: Pirinç
Yüzey Görünüm	: Krom Kaplama
Montaj	: Vidalanarak Montaj

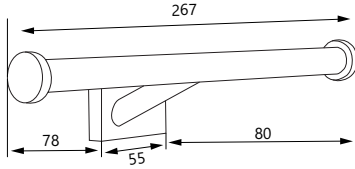

Yedek Tuvalet Kağıtlık

Spare Toilet Paper Holder

Kod/Code	Açıklama/Description
119211	Piccolo İkili Yedek Tuvalet Kağıtlık

TEKNİK DETAYLAR / Details

Malzeme	: Pirinç
Yüzey Görünüm	: Krom Kaplama
Montaj	: Vidalanarak Montaj

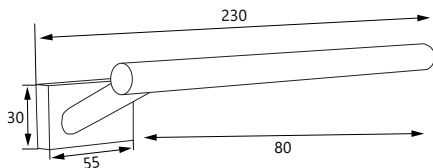

Havluluk

Towel Holder

Kod/Code	Açıklama/Description
119233	Piccolo Kısa Havluluk

TEKNİK DETAYLAR / Details

Malzeme	: Pirinç
Yüzey Görünüm	: Krom Kaplama
Montaj	: Vidalanarak Montaj



Uzun Havluluk
Towel Holder

Kod/Code	Açıklama/Description
118106	Piccolo Uzun Havluluk

TEKNİK DETAYLAR / Details

Malzeme	: Pirinç
Yüzey Görünüm	: Krom Kaplama
Montaj	: Vidalanarak Montaj

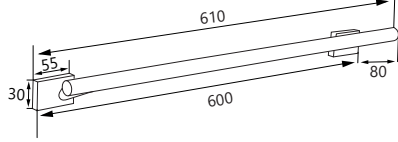

Raflı Havluluk
Towel Rack

Kod/Code	Açıklama/Description
118109	Piccolo Raf Havluluk

TEKNİK DETAYLAR / Details

Malzeme	: Pirinç
Yüzey Görünüm	: Krom Kaplama
Montaj	: Vidalanarak Montaj

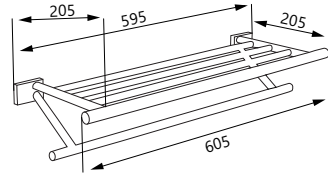



Oscar
Serisi



Bornozluk
Robe Hook

Kod/Code Açıklama/Description

129485 Oscar Bornozluk

TEKNİK DETAYLAR / Details

Malzeme : Paslanmaz
Yüzey Görünüm : Krom Kaplama
Montaj : Vidalanarak Montaj

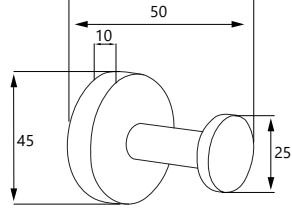

Açık Tuvalet Kağıtlık
Toilet Paper Holder

Kod/Code Açıklama/Description

118549 Oscar Tuvalet Kağıtlık

TEKNİK DETAYLAR / Details

Malzeme : Paslanmaz
Yüzey Görünüm : Krom Kaplama
Montaj : Vidalanarak Montaj

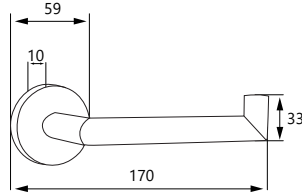

Köşeli Havluluk
Towel Holder

Kod/Code Açıklama/Description

118544 Oscar Köşeli Havluluk

TEKNİK DETAYLAR / Details

Malzeme : Paslanmaz
Yüzey Görünüm : Krom Kaplama
Montaj : Vidalanarak Montaj

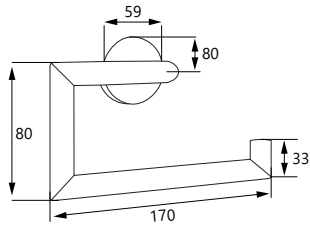

Kapaklı Tuvalet Kağıtlık
Toilet Paper Holder

Kod/Code Açıklama/Description

118550 Oscar Tuvalet Kağıtlık Kapaklı

TEKNİK DETAYLAR / Details

Malzeme : Paslanmaz
Yüzey Görünüm : Krom Kaplama
Montaj : Vidalanarak Montaj

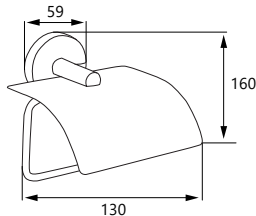

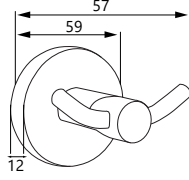

İkili Bornozluk
Double Towel Hook

Kod/Code	Açıklama/Description
165889	Oscar İkili Bornozluk

TEKNİK DETAYLAR / Details

Malzeme	: Paslanmaz
Yüzey Görünüm	: Krom Kaplama
Montaj	: Vidalanarak Montaj

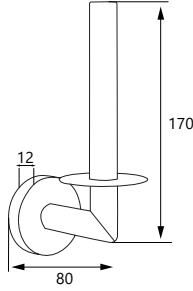

Tuvalet Kağıtlık
Toilet Paper Holder

Kod/Code	Açıklama/Description
118548	Oscar Tuvalet Kağıtlık Dikey

TEKNİK DETAYLAR / Details

Malzeme	: Paslanmaz
Yüzey Görünüm	: Krom Kaplama
Montaj	: Vidalanarak Montaj

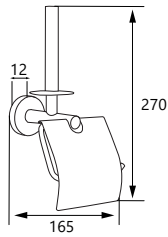

Yedek Tuvalet Kağıtlık
Toilet Paper Holder

Kod/Code	Açıklama/Description
165888	Oscar Yedekli Tuvalet Kağıtlık

TEKNİK DETAYLAR / Details

Malzeme	: Paslanmaz
Yüzey Görünüm	: Krom Kaplama
Montaj	: Vidalanarak Montaj

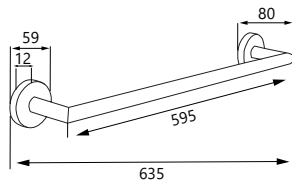

Uzun Havluluk
Towel Holder

Kod/Code	Açıklama/Description
118547	Oscar Uzun Havluluk

TEKNİK DETAYLAR / Details

Malzeme	: Paslanmaz
Yüzey Görünüm	: Krom Kaplama
Montaj	: Vidalanarak Montaj



Rafli Havluluk
Towel Rack

Kod/Code	Açıklama/Description
118552	Oscar Rafli Havluluk

TEKNİK DETAYLAR / Details	
Malzeme	: Paslanmaz
Yüzey Görünüm	: Krom Kaplama
Montaj	: Vidalanarak Montaj

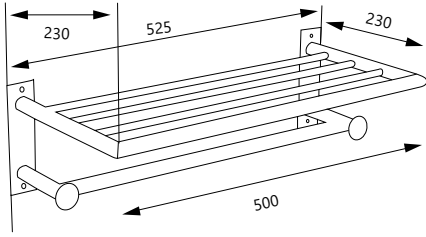



Prado
Serisi

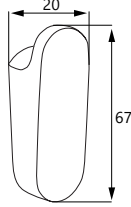

Bornozluk
Robe Hook



Kod/Code **Açıklama/Description**

119082 Prado Bornozluk

TEKNİK DETAYLAR / Details

Malzeme : Pirinç
Yüzey Görünüm : Krom Kaplama
Montaj : Vidalanarak Montaj

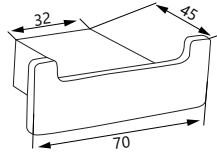

İkili Bornozluk
Double Towel Hook

Kod/Code **Açıklama/Description**

119083 Prado İkili Bornozluk

TEKNİK DETAYLAR / Details

Malzeme : Pirinç
Yüzey Görünüm : Krom Kaplama
Montaj : Vidalanarak Montaj

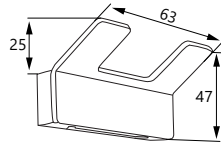

İkili Bornozluk
Double Towel Hook

Kod/Code **Açıklama/Description**

129486 Prado İkili Bornozluk

TEKNİK DETAYLAR / Details

Malzeme : Pirinç
Yüzey Görünüm : Krom Kaplama
Montaj : Vidalanarak Montaj

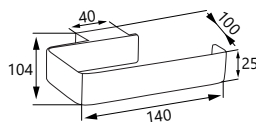

Tuvalet Kağıtlık
Toilet Paper Holder

Kod/Code **Açıklama/Description**

119085 Prado Tuvalet Kağıtlık

TEKNİK DETAYLAR / Details

Malzeme : Pirinç
Yüzey Görünüm : Krom Kaplama
Montaj : Vidalanarak Montaj

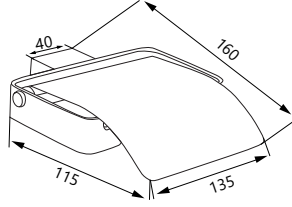

Tuvalet Kağıtlık

Toilet Paper Holder

Kod/Code	Açıklama/Description
119090	Prado Tuvalet Kağıtlık

TEKNİK DETAYLAR / Details

Malzeme	: Pirinç
Yüzey Görünüm	: Krom Kaplama
Montaj	: Vidalanarak Montaj

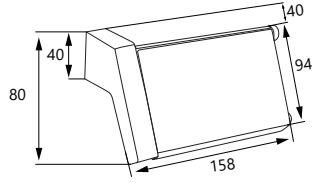

Tuvalet Kağıtlık

Toilet Paper Holder

Kod/Code	Açıklama/Description
119086	Prado Kapaklı Kağıtlık

TEKNİK DETAYLAR / Details

Malzeme	: Pirinç
Yüzey Görünüm	: Krom Kaplama
Montaj	: Vidalanarak Montaj

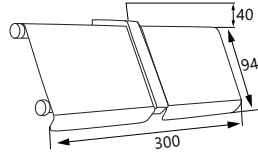

İkili Tuvalet Kağıtlık

Double Toilet Paper Holder

Kod/Code	Açıklama/Description
120306	Prado İkili Tuvalet Kağıtlık

TEKNİK DETAYLAR / Details

Malzeme	: Pirinç
Yüzey Görünüm	: Krom Kaplama
Montaj	: Vidalanarak Montaj

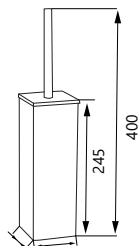

Klozet Fırçası

Toilet Brush

Kod/Code	Açıklama/Description
120384	Soho Kare Klozet Fırçası

TEKNİK DETAYLAR / Details

Malzeme	: Pirinç
Yüzey Görünüm	: Krom Kaplama
Montaj	: Vidalanarak Montaj



Uzun Havluluk
Towel Holder

Kod/Code	Açıklama/Description
119088	Prado Uzun Havluluk

TEKNİK DETAYLAR / Details

Malzeme	: Pirinç
Yüzey Görünüm	: Krom Kaplama
Montaj	: Vidalanarak Montaj

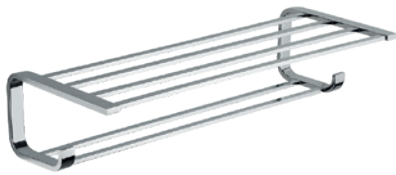
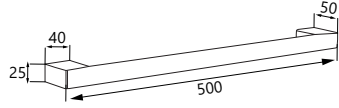

Raf Havluluk
Towel Rack

Kod/Code	Açıklama/Description
119089	Prado Raf Havluluk

TEKNİK DETAYLAR / Details

Malzeme	: Pirinç
Yüzey Görünüm	: Krom Kaplama
Montaj	: Vidalanarak Montaj

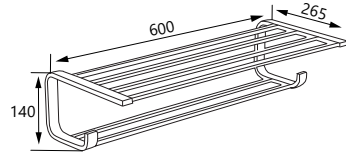

Süngerlik
Toilet Paper Holder

Kod/Code	Açıklama/Description
119087	Prado Süngerlik Köşeli

TEKNİK DETAYLAR / Details

Malzeme	: Pirinç
Yüzey Görünüm	: Krom Kaplama
Montaj	: Vidalanarak Montaj

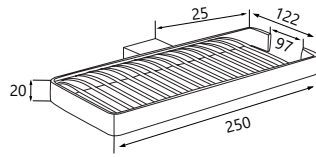



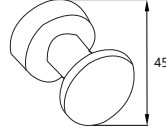

Bornozluk Robe Hook

Kod/Code	Açıklama/Description
828645	Tekli Bornozluk

TEKNİK DETAYLAR / Details	
Malzeme	: Pirinç
Yüzey Görünüm	: Krom Kaplama
Montaj	: Vidalanarak Montaj

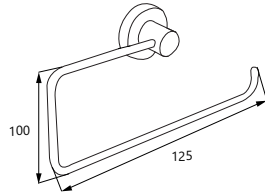

Kağıt Havluluk Paper Holder

Kod/Code	Açıklama/Description
334465	Kağıt Havluluk

TEKNİK DETAYLAR / Details	
Malzeme	: Pirinç
Yüzey Görünüm	: Krom Kaplama
Montaj	: Vidalanarak Montaj

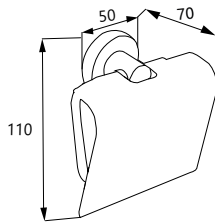

Kapaklı Tuvalet kağıtlıkları Toilet Paper Holder

Kod/Code	Açıklama/Description
328653	Kapaklı Tuvalet Kağıtlık

TEKNİK DETAYLAR / Details	
Malzeme	: Pirinç
Yüzey Görünüm	: Krom Kaplama
Montaj	: Vidalanarak Montaj

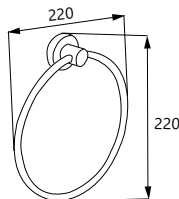

Yuvarlak Havluluk Circle Holder

Kod/Code	Açıklama/Description
328650	Yuvarlak Havluluk

TEKNİK DETAYLAR / Details	
Malzeme	: Pirinç
Yüzey Görünüm	: Krom Kaplama
Montaj	: Vidalanarak Montaj

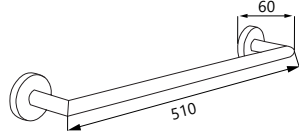

Uzun Havluluk

Long Holder

Kod/Code	Açıklama/Description
328649	Uzun Havluluk

TEKNİK DETAYLAR / Details

Malzeme	: Pirinç
Yüzey Görünüm	: Krom Kaplama
Montaj	: Vidalanarak Montaj

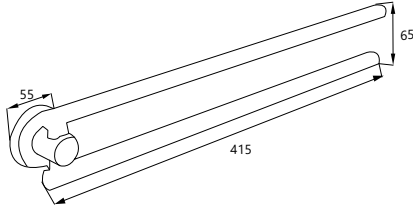

İkili Havluluk

Double Holder

Kod/Code	Açıklama/Description
328646	İkili Havluluk Krom

TEKNİK DETAYLAR / Details

Malzeme	: Pirinç
Yüzey Görünüm	: Krom Kaplama
Montaj	: Vidalanarak Montaj

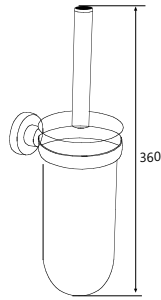

Klozet Fırçalık

Toilet Brush

Kod/Code	Açıklama/Description
328652	Klozet Fırçalık

TEKNİK DETAYLAR / Details

Malzeme	: Pirinç
Yüzey Görünüm	: Krom Kaplama
Montaj	: Vidalanarak Montaj

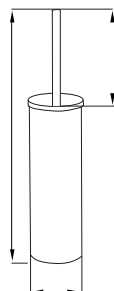

Klozet Fırçalık

Toilet Brush

Kod/Code	Açıklama/Description
120386	Elegance Klozet Fırçalık

TEKNİK DETAYLAR / Details

Malzeme	: Pirinç
Yüzey Görünüm	: Krom Kaplama
Montaj	: Yerden / Vidalanarak Montaj

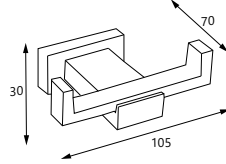

İkili Askılık

Double Towel Hook

Kod/Code	Açıklama/Description
320892	İkili Askılık

TEKNİK DETAYLAR / Details

Malzeme	: Pirinç
Yüzey Görünüm	: Krom Kaplama
Montaj	: Vidalanarak Montaj
Renkler	: Siyah, Krom

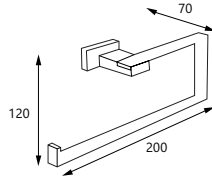
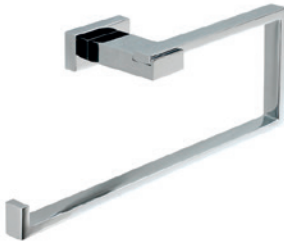

Kağıt Havluluk

Paper Holder

Kod/Code	Açıklama/Description
334477	Kağıt Havluluk

TEKNİK DETAYLAR / Details

Malzeme	: Pirinç
Yüzey Görünüm	: Krom Kaplama
Montaj	: Vidalanarak Montaj
Renkler	: Siyah, Krom

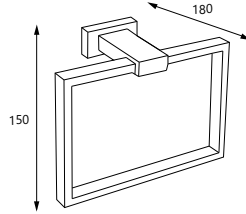

Halka Havluluk

Ring Towel Holder

Kod/Code	Açıklama/Description
320894	Halka Havluluk

TEKNİK DETAYLAR / Details

Malzeme	: Pirinç
Yüzey Görünüm	: Krom Kaplama
Montaj	: Vidalanarak Montaj
Renkler	: Siyah, Krom

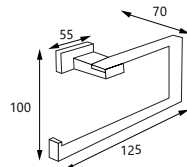

WC Kağıtlık

WC Paper Holder

Kod/Code	Açıklama/Description
320891	Açık WC Kağıtlık

TEKNİK DETAYLAR / Details

Malzeme	: Pirinç
Yüzey Görünüm	: Krom Kaplama
Montaj	: Vidalanarak Montaj
Renkler	: Siyah, Krom

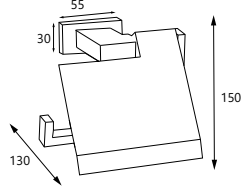

Kapaklı WC Kağıtlık

Covered WC Paper Holder

Kod/Code	Açıklama/Description
320893	Kapaklı Wc Kağıtlık

TEKNİK DETAYLAR / Details

Malzeme	: Pirinç
Yüzey Görünüm	: Krom Kaplama
Montaj	: Vidalanarak Montaj
Renkler	: Siyah, Krom

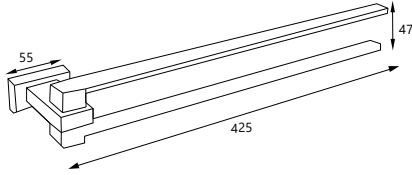

İkili Havluluk

Double Holder

Kod/Code	Açıklama/Description
320896	İkili Hareketli Havluluk

TEKNİK DETAYLAR / Details

Malzeme	: Pirinç
Yüzey Görünüm	: Krom Kaplama
Montaj	: Vidalanarak Montaj
Renkler	: Siyah, Krom

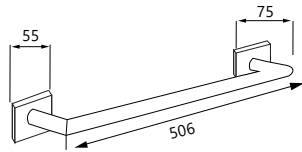

Uzun Havluluk

Long Holder

Kod/Code	Açıklama/Description
320895	Uzun Havluluk

TEKNİK DETAYLAR / Details

Malzeme	: Pirinç
Yüzey Görünüm	: Krom Kaplama
Montaj	: Vidalanarak Montaj
Renkler	: Siyah, Krom

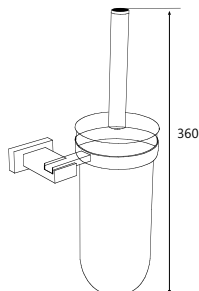

WC Fırçalık

Toilet Brush

Kod/Code	Açıklama/Description
322690	WC Fırçalık

TEKNİK DETAYLAR / Details

Malzeme	: Pirinç
Yüzey Görünüm	: Krom Kaplama
Montaj	: Vidalanarak Montaj
Renkler	: Siyah, Krom



**Gürz
Serisi**

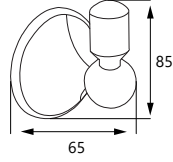

Tekli Askılık

Robe Hook

Kod/Code	Açıklama/Description
320253	Gürz Tekli Askılık

TEKNİK DETAYLAR / Details	
Malzeme	: Pirinç
Yüzey Görünüm	: Krom Kaplama
Montaj	: Vidalanarak Montaj

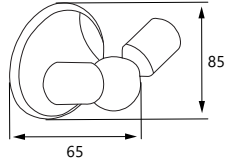

İkili Askılık

Double Towel Hook

Kod/Code	Açıklama/Description
320254	Gürz İkili Askılık

TEKNİK DETAYLAR / Details	
Malzeme	: Pirinç
Yüzey Görünüm	: Krom Kaplama
Montaj	: Vidalanarak Montaj

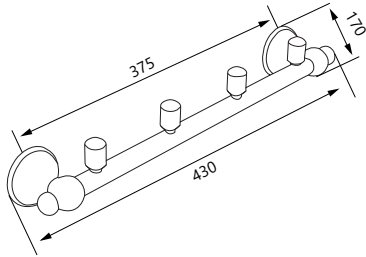
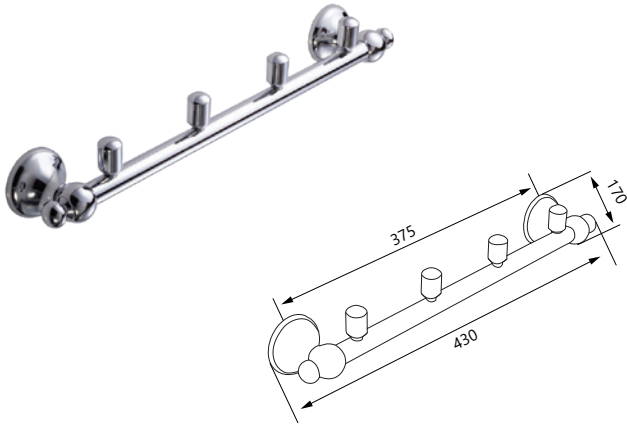

Dörtlü Askılık

Robe Hook

Kod/Code	Açıklama/Description
320261	Gürz Dörtlü Askılık

TEKNİK DETAYLAR / Details	
Malzeme	: Pirinç
Yüzey Görünüm	: Krom Kaplama
Montaj	: Vidalanarak Montaj

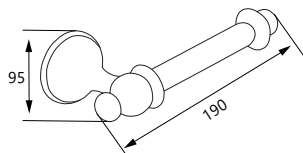

Tuvalet Kağıtlık

Toilet Paper Holder

Kod/Code	Açıklama/Description
320255	Gürz Tuvalet Kağıtlık

TEKNİK DETAYLAR / Details	
Malzeme	: Pirinç
Yüzey Görünüm	: Krom Kaplama
Montaj	: Vidalanarak Montaj

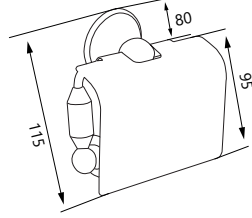

Tuvalet Kağıtlık Kapaklı Towel Holder

Kod/Code	Açıklama/Description
320258	Gürz Tuvalet Kağıtlık Kapaklı

TEKNİK DETAYLAR / Details

Malzeme	: Pirinç
Yüzey Görünüm	: Krom Kaplama
Montaj	: Vidalanarak Montaj

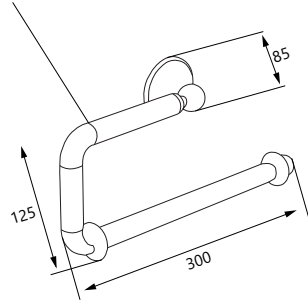

Kağıt Havluluk Towel Holder

Kod/Code	Açıklama/Description
320256	Gürz Kağıt Havluluk

TEKNİK DETAYLAR / Details

Malzeme	: Pirinç
Yüzey Görünüm	: Krom Kaplama
Montaj	: Vidalanarak Montaj

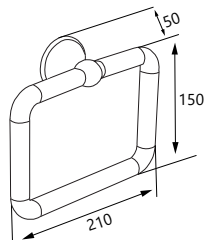

Halka Havluluk Ring Towel Holder

Kod/Code	Açıklama/Description
320259	Gürz Halka Havluluk

TEKNİK DETAYLAR / Details

Malzeme	: Pirinç
Yüzey Görünüm	: Krom Kaplama
Montaj	: Vidalanarak Montaj

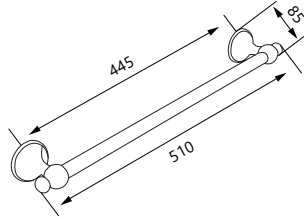

Uzun Havluluk

Towel Rack

Kod/Code	Açıklama/Description
320260	Gürz Uzun Havluluk

TEKNİK DETAYLAR / Details	
Malzeme	: Pirinç
Yüzey Görünüm	: Krom Kaplama
Montaj	: Vidalanarak Montaj

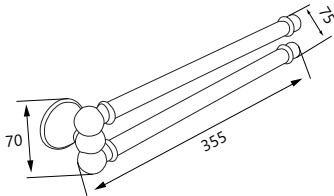

Hareketli Havluluk

Toilet Paper Holder

Kod/Code	Açıklama/Description
320257	Gürz Hareketli Havluluk

TEKNİK DETAYLAR / Details	
Malzeme	: Pirinç
Yüzey Görünüm	: Krom Kaplama
Montaj	: Vidalanarak Montaj

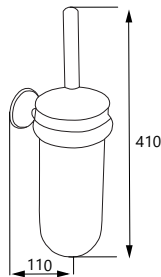

Klozet Fırçalık

Toilet Brush Holder

Kod/Code	Açıklama/Description
327935	Gürz Klozet Fırçası

TEKNİK DETAYLAR / Details	
Malzeme	: Pirinç
Yüzey Görünüm	: Krom Kaplama
Montaj	: Vidalanarak Montaj

Ekselans

Serisi



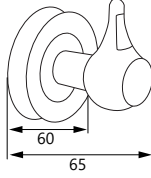

Tekli Askılık

Robe Hook

Kod/Code	Açıklama/Description
320882	Ekselans Tekli Askılık

TEKNİK DETAYLAR / Details	
Malzeme	: Piriç
Yüzey Görünüm	: Antik
Montaj	: Vidalanarak Montaj

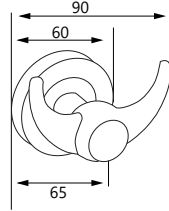

İkili Askılık

Double Towel Hook

Kod/Code	Açıklama/Description
320883	Ekselans İkili Askılık

TEKNİK DETAYLAR / Details	
Malzeme	: Piriç
Yüzey Görünüm	: Antik
Montaj	: Vidalanarak Montaj

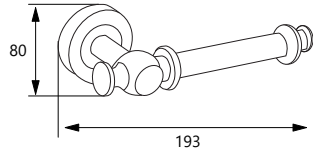

Tuvalet Kağıtlık

Toilet Paper Holder

Kod/Code	Açıklama/Description
320884	Ekselans Tuvalet Kağıtlık

TEKNİK DETAYLAR / Details	
Malzeme	: Piriç
Yüzey Görünüm	: Antik
Montaj	: Vidalanarak Montaj

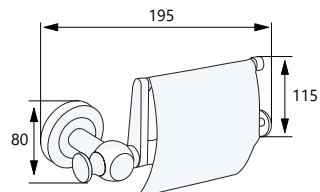

Tuvalet Kağıtlık Kapaklı

Toilet Paper Holder

Kod/Code	Açıklama/Description
320886	Ekselans Kapaklı Tuvalet Kağıtlık

TEKNİK DETAYLAR / Details	
Malzeme	: Piriç
Yüzey Görünüm	: Antik
Montaj	: Vidalanarak Montaj



Diş Fırçalık Glass Holder

Kod/Code	Açıklama/Description
327928	Ekselans Diş Fırçalık

TEKNİK DETAYLAR / Details

Malzeme	: Pirinç
Yüzey Görünüm	: Antik
Montaj	: Vidalanarak Montaj

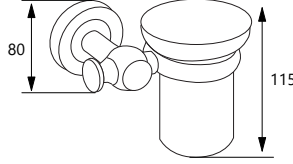

Yuvarlak Havluluk Towel Holder

Kod/Code	Açıklama/Description
320885	Ekselans Yuvarlak Havluluk

TEKNİK DETAYLAR / Details

Malzeme	: Pirinç
Yüzey Görünüm	: Antik
Montaj	: Vidalanarak Montaj

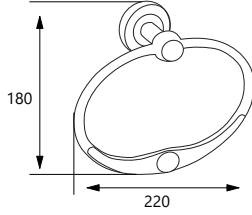

Kağıt Havluluk Towel Paper Holder

Kod/Code	Açıklama/Description
327926	Ekselans Kağıt Havluluk

TEKNİK DETAYLAR / Details

Malzeme	: Pirinç
Yüzey Görünüm	: Antik
Montaj	: Vidalanarak Montaj

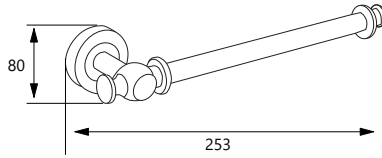

Uzun Havluluk Towel Holder

Kod/Code	Açıklama/Description
320888	Ekselans Uzun Havluluk

TEKNİK DETAYLAR / Details

Malzeme	: Pirinç
Yüzey Görünüm	: Antik
Montaj	: Vidalanarak Montaj

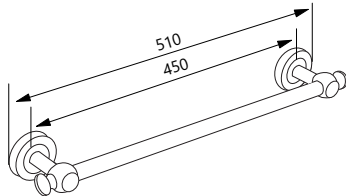

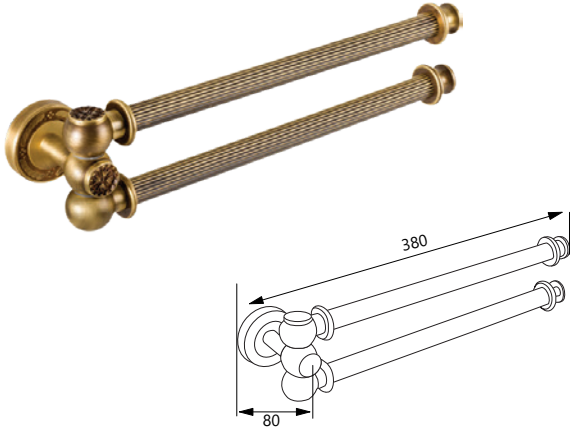

Hareketli Havluluk
Toilet Paper Holder

Kod/Code	Açıklama/Description
327887	Ekselans Hareketli Havluluk

TEKNİK DETAYLAR / Details	
Malzeme	: Pirinç
Yüzey Görünüm	: Antik
Montaj	: Vidalanarak Montaj

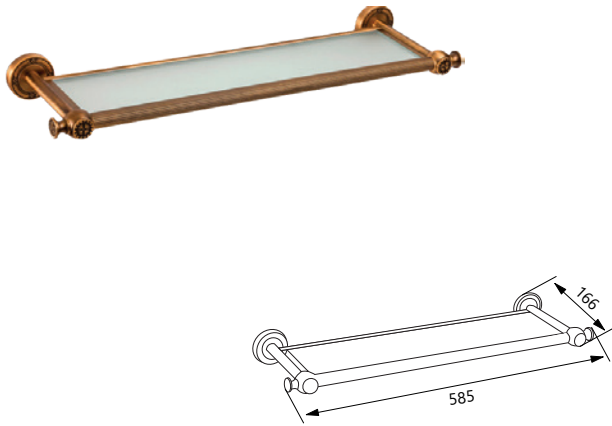

Etajer
Towel Holder

Kod/Code	Açıklama/Description
327931	Ekselans Etajer

TEKNİK DETAYLAR / Details	
Malzeme	: Pirinç
Yüzey Görünüm	: Antik
Montaj	: Vidalanarak Montaj

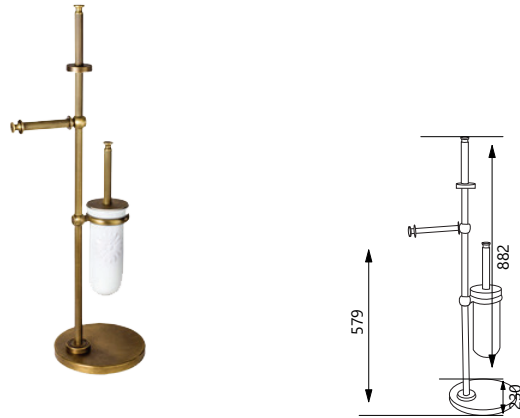

Ayaklı Klozet Fırçalık ve Tuvalet Kağıtlık
Free-Standing / Toilet Brush Holder - Toilet Paper Holder

Kod/Code	Açıklama/Description
320930	Ekselans Ayaklı Klozet Fırçalık ve Tuvalet Kağıtlık

TEKNİK DETAYLAR / Details	
Malzeme	: Pirinç
Yüzey Görünüm	: Antik
Montaj	: Vidalanarak Montaj



Ayaklı Klozet Fırçalık
Free-Standing Toilet Brush Holder

Kod/Code	Açıklama/Description
327929	Ekselans Ayaklı Klozet Fırçalık

TEKNİK DETAYLAR / Details	
Malzeme	: Pirinç
Yüzey Görünüm	: Antik
Montaj	: Vidalanarak Montaj

Elegancia

Serisi



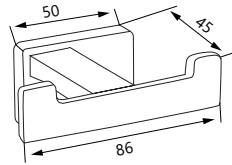
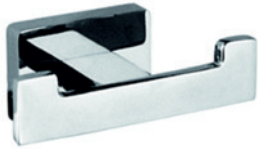

İkili Bornozluk

Double Towel Hook

Kod/Code	Açıklama/Description
056892	Elegancia İkili Bornozluk

TEKNİK DETAYLAR / Details

Malzeme	: Pirinç
Yüzey Görünüm	: Krom Kaplama
Montaj	: Vidalanarak Montaj

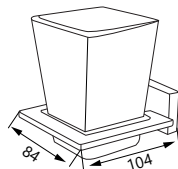

Diş Fırçalık

Tooth Brush Holder

Kod/Code	Açıklama/Description
056890	Elegancia Diş Fırçalık

TEKNİK DETAYLAR / Details

Malzeme	: Pirinç
Yüzey Görünüm	: Krom Kaplama
Montaj	: Vidalanarak Montaj



Sabunluk Soap Holder

Kod/Code	Açıklama/Description
056889	Elegancia Sabunluk

TEKNİK DETAYLAR / Details

Malzeme	: Pirinç
Yüzey Görünüm	: Krom Kaplama
Montaj	: Vidalanarak Montaj

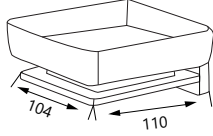

Yuvarlak Havluluk Towel Holder

Kod/Code	Açıklama/Description
056888	Elegancia Yuvarlak Havluluk

TEKNİK DETAYLAR / Details

Malzeme	: Pirinç
Yüzey Görünüm	: Krom Kaplama
Montaj	: Vidalanarak Montaj

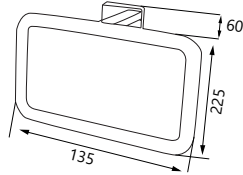

Tuvalet Kağıtlık Toilet Paper Holder

Kod/Code	Açıklama/Description
166903	Elegancia Tuvalet Kağıtlık

TEKNİK DETAYLAR / Details

Malzeme	: Pirinç
Yüzey Görünüm	: Krom Kaplama
Montaj	: Vidalanarak Montaj

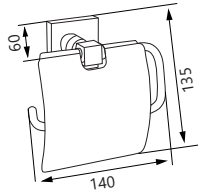

Tuvalet Kağıtlık Toilet Paper Holder

Kod/Code	Açıklama/Description
065891	Elegancia Tuvalet Kağıtlık

TEKNİK DETAYLAR / Details

Malzeme	: Pirinç
Yüzey Görünüm	: Krom Kaplama
Montaj	: Vidalanarak Montaj

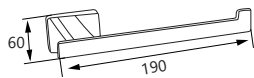

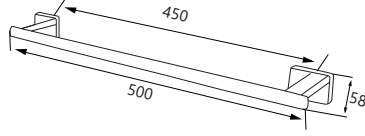

Uzun Havluluk

Towel Holder

Kod/Code	Açıklama/Description
056887	Elegancia Uzun Havluluk

TEKNİK DETAYLAR / Details

Malzeme	: Pirinç
Yüzey Görünüm	: Krom Kaplama
Montaj	: Vidalanarak Montaj

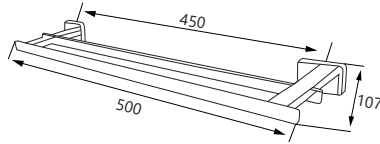

İkili Uzun Havluluk

Towel Holder

Kod/Code	Açıklama/Description
056894	Elegancia İkili Uzun Havluluk

TEKNİK DETAYLAR / Details

Malzeme	: Pirinç
Yüzey Görünüm	: Krom Kaplama
Montaj	: Vidalanarak Montaj

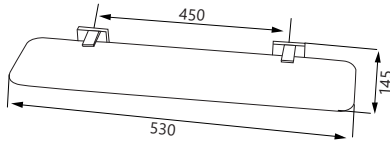

Etajer

Etajere

Kod/Code	Açıklama/Description
056886	Elegancia Etajer

TEKNİK DETAYLAR / Details

Malzeme	: Pirinç
Yüzey Görünüm	: Krom Kaplama
Montaj	: Vidalanarak Montaj

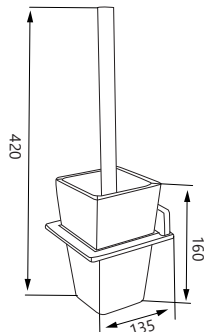

Klozet Fırçalık

Toilet Brush

Kod/Code	Açıklama/Description
056893	Elegancia Klozet Fırçalık

TEKNİK DETAYLAR / Details

Malzeme	: Pirinç
Yüzey Görünüm	: Krom Kaplama
Montaj	: Vidalanarak Montaj

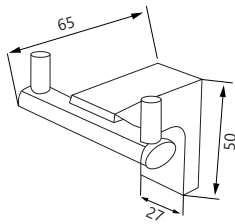

İkili Bornozluk Double Towel Hook

Kod/Code	Açıklama/Description
223227	Alora İkili Bornozluk

TEKNİK DETAYLAR / Details

Malzeme	: Pirinç
Yüzey Görünüm	: Krom Kaplama
Montaj	: Vidalanarak Montaj

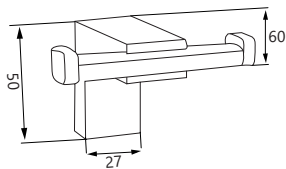

İkili Bornozluk Double Towel Hook

Kod/Code	Açıklama/Description
223228	Alora İkili Bornozluk

TEKNİK DETAYLAR / Details

Malzeme	: Pirinç
Yüzey Görünüm	: Krom Kaplama
Montaj	: Vidalanarak Montaj



Sabunluk
Soap Holder

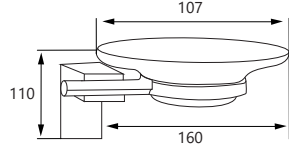

Kod/Code	Açıklama/Description
223229	Alora Sabunluk

TEKNİK DETAYLAR / Details

Malzeme	: Pirinç
Yüzey Görünüm	: Krom Kaplama
Montaj	: Vidalanarak Montaj



Diş Fırçalık
Tooth Brush Holder

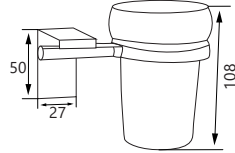

Kod/Code	Açıklama/Description
223230	Alora Diş Fırçalık

TEKNİK DETAYLAR / Details

Malzeme	: Pirinç
Yüzey Görünüm	: Krom Kaplama
Montaj	: Vidalanarak Montaj



Uzun Havluluk
Towel Holder

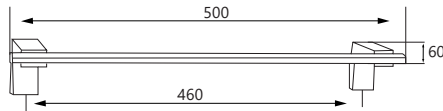

Kod/Code	Açıklama/Description
223231	Alora Uzun Havluluk

TEKNİK DETAYLAR / Details

Malzeme	: Pirinç
Yüzey Görünüm	: Krom Kaplama
Montaj	: Vidalanarak Montaj



Kısa Havluluk
Towel Holder

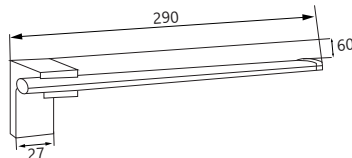

Kod/Code	Açıklama/Description
223234	Alora Kısa Havluluk

TEKNİK DETAYLAR / Details

Malzeme	: Pirinç
Yüzey Görünüm	: Krom Kaplama
Montaj	: Vidalanarak Montaj



Tuvalet Kağıtlık
Toilet Paper Holder

Kod/Code	Açıklama/Description
223232	Alora Tuvalet Kağıtlık

TEKNİK DETAYLAR / Details

Malzeme	: Pirinç
Yüzey Görünüm	: Krom Kaplama
Montaj	: Vidalanarak Montaj

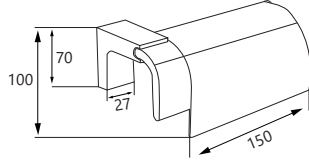

Tuvalet Kağıtlık
Toilet Paper Holder

Kod/Code	Açıklama/Description
223233	Alora Tuvalet Kağıtlık

TEKNİK DETAYLAR / Details

Malzeme	: Pirinç
Yüzey Görünüm	: Krom Kaplama
Montaj	: Vidalanarak Montaj

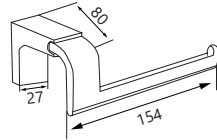

Etajer
Etajere

Kod/Code	Açıklama/Description
223230	Alora Etajer

TEKNİK DETAYLAR / Details

Malzeme	: Pirinç
Yüzey Görünüm	: Krom Kaplama
Montaj	: Vidalanarak Montaj

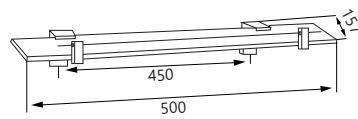

Klozet Fırçalık Krom
Toilet Brush

Kod/Code	Açıklama/Description
223235	Alora Klozet Fırçalık

TEKNİK DETAYLAR / Details

Malzeme	: Pirinç
Yüzey Görünüm	: Krom Kaplama
Montaj	: Vidalanarak Montaj

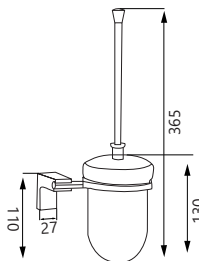



Gümüş Ayna Mirror

Özel El Yapımı
Desen

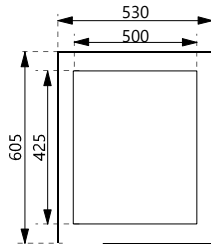

Kod/Code Açıklama/Description

073667 Gümüş Ayna

TEKNİK DETAYLAR / Details

Malzeme : Seramik + Ayna
Yüzey Görünüm : El Yapımı Özel Desen
Montaj : Duvara Monte

> İsteğe Bağlı Özel Ölçülerde Üretim Yapılmaktadır.



Burcu Ayna Mirror

Özel El Yapımı
Desen

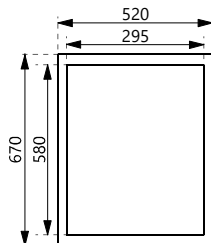

Kod/Code Açıklama/Description

073666 Burcu Ayna

TEKNİK DETAYLAR / Details

Malzeme : Seramik + Ayna
Yüzey Görünüm : El Yapımı Özel Desen
Montaj : Duvara Monte

> İsteğe Bağlı Özel Ölçülerde Üretim Yapılmaktadır.



Oval Tezgah Üstü Lavabo E4542

Sink

Özel El Yapımı
Desen

Kod/Code	Açıklama/Description
073668	Oval Tezgah Üstü Lavabo Özel Desen

TEKNİK DETAYLAR / Details

Malzeme	: Seramik + Pirinç
Yüzey Görünüm	: El Yapımı Özel Desen
Montaj	: Tezgah Üstü

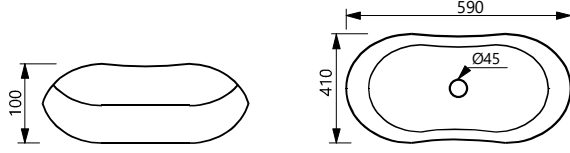

Yuvarlak Tezgah Üstü Lavabo

Sink

Özel El Yapımı
Desen

Kod/Code	Açıklama/Description
073669	Yuvarlak Tezgah Üstü Lavabo Özel Desen

TEKNİK DETAYLAR / Details

Malzeme	: Seramik + Pirinç
Yüzey Görünüm	: El Yapımı Özel Desen
Montaj	: Tezgah Üstü

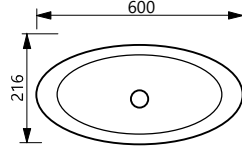

Krom Beyaz Silindir Sıvı Sabunluk - 1204 Seri

Soap Dispenser

Özel El Yapımı
Desen

Kod/Code	Açıklama/Description
073673	Krom Beyaz Silindir Sıvı Sabunluk 1204

TEKNİK DETAYLAR / Details

Malzeme	: Seramik + Pirinç
Yüzey Görünüm	: El Yapımı Özel Desen
Montaj	: Tezgah Üstü

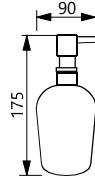

Silindir Diş Fırçalık Beyaz - 1201 Seri

Tooth Brush Holder

Özel El Yapımı
Desen

Kod/Code	Açıklama/Description
073674	Silindir Diş Fırçalık Beyaz 1201

TEKNİK DETAYLAR / Details

Malzeme	: Seramik + Pirinç
Yüzey Görünüm	: El Yapımı Özel Desen
Montaj	: Tezgah Üstü

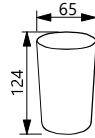

Katı Sabunluk Beyaz - 1200 Seri

Soap Holder

Özel El Yapımı
Desen

Kod/Code	Açıklama/Description
073675	Katı Sabunluk Beyaz 1200

TEKNİK DETAYLAR / Details

Malzeme	: Seramik + Pirinç
Yüzey Görünüm	: El Yapımı Özel Desen
Montaj	: Tezgah Üstü

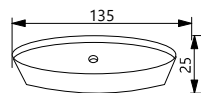



İkili Bornoz Askılık - 2000 Seri
Double Towel Hook

**Özel El Yapımı
Desen**

Kod/Code	Açıklama/Description
073676	Kayra Antik Krem İkili Bornoz Askılık

TEKNİK DETAYLAR / Details

Malzeme	: Seramik + Piriç
Yüzey Görünüm	: El Yapımı Özel Desen
Montaj	: Duvara Monte, Vidalanarak

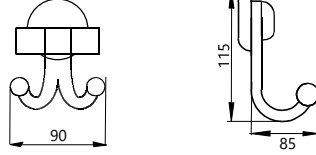

Katı Sabunluk - 2002 Seri
Soap Holder

**Özel El Yapımı
Desen**

Kod/Code	Açıklama/Description
073677	Kayra Antik Krem Katı Sabunluk

TEKNİK DETAYLAR / Details

Malzeme	: Seramik + Piriç
Yüzey Görünüm	: El Yapımı Özel Desen
Montaj	: Duvara Monte, Vidalanarak

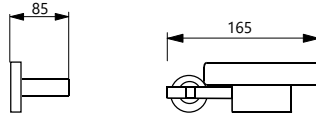

Diş Fırçalık - 2001 Seri
Tooth Brush Holder

**Özel El Yapımı
Desen**

Kod/Code	Açıklama/Description
073678	Kayra Antik Krem Diş Fırçalık

TEKNİK DETAYLAR / Details

Malzeme	: Seramik + Piriç
Yüzey Görünüm	: El Yapımı Özel Desen
Montaj	: Duvara Monte, Vidalanarak

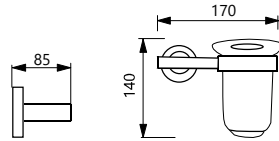

Etajer - 2003 Seri
Etager

**Özel El Yapımı
Desen**

Kod/Code	Açıklama/Description
073679	Antik Krem Etajer

TEKNİK DETAYLAR / Details

Malzeme	: Seramik + Piriç
Yüzey Görünüm	: El Yapımı Özel Desen
Montaj	: Duvara Monte, Vidalanarak

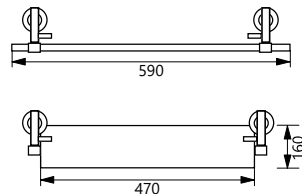



Yuvarlak Havluluk - 2007 Seri
Towel Holder

Özel El Yapımı
Desen

Kod/Code	Açıklama/Description
073680	Kayra Antik Krem Yuvarlak Havluluk

TEKNİK DETAYLAR / Details

Malzeme	: Seramik + Pirinç
Yüzey Görünüm	: El Yapımı Özel Desen
Montaj	: Duvara Monte, Vidalanarak

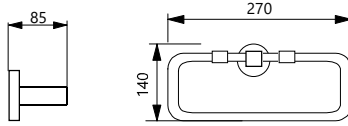

Tuvalet Kağıtlık Kapaklı - 2004 Seri
Toilet Paper Holder

Özel El Yapımı
Desen

Kod/Code	Açıklama/Description
073681	Kayra Antik Krem Tuvalet Kağıtlık Kapaklı

TEKNİK DETAYLAR / Details

Malzeme	: Seramik + Pirinç
Yüzey Görünüm	: El Yapımı Özel Desen
Montaj	: Duvara Monte, Vidalanarak

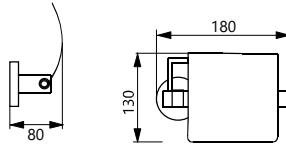

Klozet Fırçası - 2008 Seri
Toilet Brush

Özel El Yapımı
Desen

Kod/Code	Açıklama/Description
073682	Kayra Antik Krem Klozet Fırçası

TEKNİK DETAYLAR / Details

Malzeme	: Seramik + Pirinç
Yüzey Görünüm	: El Yapımı Özel Desen
Montaj	: Duvara Monte, Vidalanarak

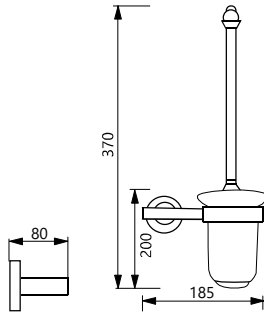

Çöp Kovası - 1000 Seri
Waste Bin

Özel El Yapımı
Desen

Kod/Code	Açıklama/Description
073683	Kayra Antik Krem Çöp Kovası

TEKNİK DETAYLAR / Details

Malzeme	: Seramik + Pirinç
Yüzey Görünüm	: El Yapımı Özel Desen

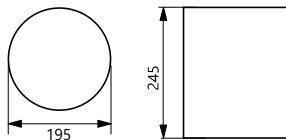

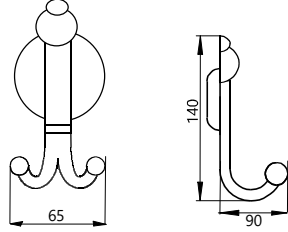

Bornoz Askılık - 600 Seri

Double Towel Hook

Özel El Yapımı
Desen

> Sipariş Kodları Düz Beyaz Seramiktir.

Krom	Antik	Altın	Saten
058289	058288	058284	073685

TEKNİK DETAYLAR / Details

Malzeme	: Seramik + Piriç
Yüzey Görünüm	: El Yapımı Özel Desen
Montaj	: Duvara Monte, Vidalanarak

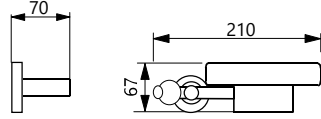

Katı Sabunluk - 602 Seri

Soap Holder

Özel El Yapımı
Desen

> Sipariş Kodları Düz Beyaz Seramiktir.

Krom	Antik	Altın	Saten
071646	071634	058277	073686

TEKNİK DETAYLAR / Details

Malzeme	: Seramik + Piriç
Yüzey Görünüm	: El Yapımı Özel Desen
Montaj	: Duvara Monte, Vidalanarak

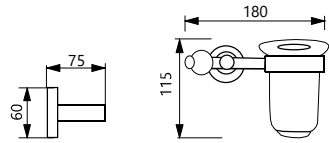

Diş Fırçalık - 601 Seri

Tooth Brush Holder

Özel El Yapımı
Desen

> Sipariş Kodları Düz Beyaz Seramiktir.

Krom	Antik	Altın	Saten
073687	073688	058278	073689

TEKNİK DETAYLAR / Details

Malzeme	: Seramik + Piriç
Yüzey Görünüm	: El Yapımı Özel Desen
Montaj	: Duvara Monte, Vidalanarak

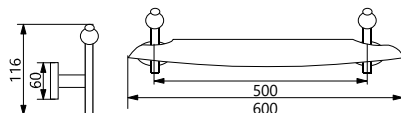

Etajer - 603 Seri

Etagere

Özel El Yapımı
Desen

> Sipariş Kodları Düz Beyaz Seramiktir.

Krom	Antik	Altın	Saten
073690	073691	058276	073692

TEKNİK DETAYLAR / Details

Malzeme	: Seramik + Piriç
Yüzey Görünüm	: El Yapımı Özel Desen
Montaj	: Duvara Monte, Vidalanarak



Uzun Havluluk 600 mm - 607 Seri

Towel Holder Long - 607 series

**Özel El Yapımı
Desen**

> Sipariş Kodları Düz Beyaz Seramiktir.

Krom	Antik	Altın	Saten
073693	072223	058282	073694

TEKNİK DETAYLAR / Details

Malzeme	: Seramik + Pirinç
Yüzey Görünüm	: El Yapımı Özel Desen
Montaj	: Duvara Monte, Vidalanarak

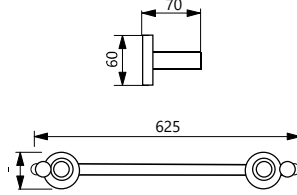

İkili Havluluk - 609 Seri

Zarm Swivel Towel bar

**Özel El Yapımı
Desen**

> Sipariş Kodları Düz Beyaz Seramiktir.

Krom	Antik	Altın	Saten
073695	072224	058281	073696

TEKNİK DETAYLAR / Details

Malzeme	: Seramik + Pirinç
Yüzey Görünüm	: El Yapımı Özel Desen
Montaj	: Duvara Monte, Vidalanarak

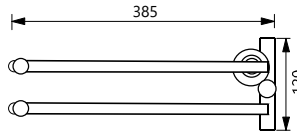

Yuvarlak Havluluk - 610 Seri

Towel Holder 610 Series

**Özel El Yapımı
Desen**

> Sipariş Kodları Düz Beyaz Seramiktir.

Krom	Antik	Altın	Saten
071648	071635	058279	073697

TEKNİK DETAYLAR / Details

Malzeme	: Seramik + Pirinç
Yüzey Görünüm	: El Yapımı Özel Desen
Montaj	: Duvara Monte, Vidalanarak

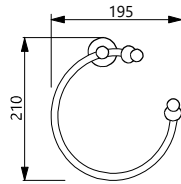

Tuvalet Kağıtlık - 605 Seri

Toilet Roll Holder 605 Series

**Özel El Yapımı
Desen**

> Sipariş Kodları Düz Beyaz Seramiktir.

Krom	Antik	Altın	Saten
071647	071633	058274	073698

TEKNİK DETAYLAR / Details

Malzeme	: Seramik + Pirinç
Yüzey Görünüm	: El Yapımı Özel Desen
Montaj	: Duvara Monte, Vidalanarak

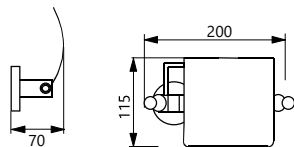

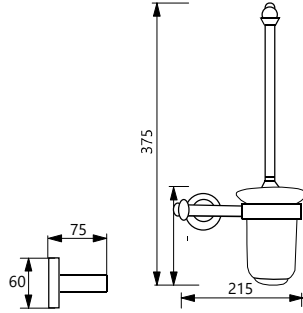

Klozet Fırçası - 604 Seri

Toilet Brush - 604 Series

Özel El Yapımı Desen

Krom	Antik	Altın	Saten
071649	071632	058275	073699

TEKNİK DETAYLAR / Details

Malzeme : Seramik + Pirinç
Yüzey Görünüm : El Yapımı Özel Desen

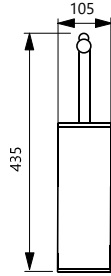

WC Fırçalık - 1100 Seri

Free-Standing Toilet Brush - 1100 Series

Özel El Yapımı Desen

Krom	Antik	Altın	Saten
073700	073702	058287	073701

TEKNİK DETAYLAR / Details

Malzeme : Seramik + Pirinç
Yüzey Görünüm : El Yapımı Özel Desen

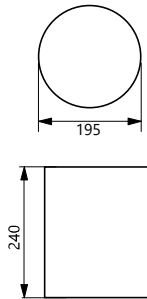

Çöp Kovası - 1000 Seri

Waste Bin - 1000 Series

Özel El Yapımı Desen

Krom	Antik	Altın	Saten
071650	073704	058286	073703

TEKNİK DETAYLAR / Details

Malzeme : Seramik + Pirinç
Yüzey Görünüm : El Yapımı Özel Desen



Ayaklı Set - 1400 Seri

Free-Standing Toilet Set - 1400 Series

Özel El Yapımı Desen

Krom	Antik	Altın	Saten
073706	073705	073708	073707

TEKNİK DETAYLAR / Details

Malzeme : Seramik + Pirinç
Yüzey Görünüm : El Yapımı Özel Desen

Otel
Serisi





Traş, Makyaj Aynaları
Wall Mounted Make-up
Mirror With Light

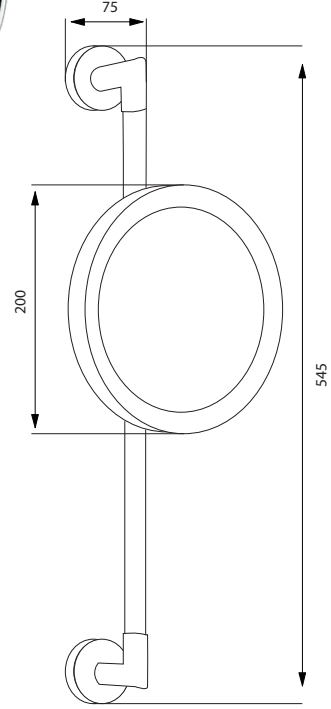

Kod/Code	Açıklama/Description
126448	Soho Işıklı Makyaj Aynası

TEKNİK DETAYLAR / Details	
Malzeme	: Pirinç
Yüzey Görünüm	: Krom Kaplama
Montaj	: Vidalanarak Montaj

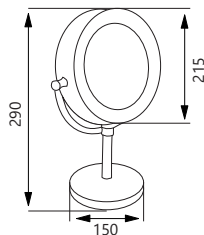

Traş, Makyaj Aynaları
Countertop Round Mirror With Light

Kod/Code	Açıklama/Description
060416	Soho Işıklı Tezgah Üstü

TEKNİK DETAYLAR / Details	
Malzeme	: Pirinç
Yüzey Görünüm	: Krom Kaplama
Montaj	: Vidalanarak Montaj

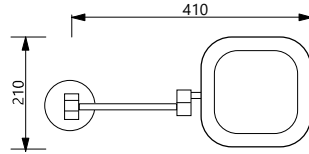

Kare Led Ayna

Wall Mounted Square Make-up
Mirror With Led

SOHO DESIGN

Kod/Code	Açıklama/Description
060898	Soho Kare Led Ayna

TEKNİK DETAYLAR / Details

Malzeme	: Pirinç
Yüzey Görünüm	: Krom Kaplama
Montaj	: Vidalanarak

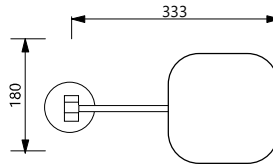

Duvara Monte Makyaj Aynası

Wall Mounted Make-up Mirror

Kod/Code	Açıklama/Description
060414	Duvara Monte Makyaj Aynası Krom

TEKNİK DETAYLAR / Details

Malzeme	: Pirinç
Yüzey Görünüm	: Krom Kaplama
Montaj	: Duvara Monte, Vidalanarak

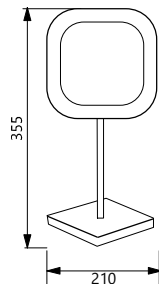

Tezgah Üstü Kare Led Ayna

Counter Top Square Make-up
Mirror With Led

SOHO DESIGN

Kod/Code	Açıklama/Description
073710	Soho Tezgah Üstü Kare Led Ayna

TEKNİK DETAYLAR / Details

Malzeme	: Pirinç
Yüzey Görünüm	: Krom Kaplama
Montaj	: Tezgah Üstü



SOHO DESIGN



Traş, Makyaj Aynaları Wall Mounted Make-Up Mirror With Light

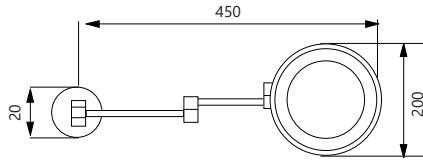

Kod/Code	Açıklama/Description
126448	Soho Işıklı Makyaj Aynası

TEKNİK DETAYLAR / Details

Malzeme	: Pirinç
Yüzey Görünüm	: Krom Kaplama
Montaj	: Vidalanarak Montaj

SOHO DESIGN



Traş, Makyaj Aynaları Wall Mounted Round Make-Up Mirror

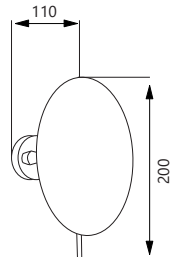

Kod/Code	Açıklama/Description
126450	Soho Makyaj Aynası

TEKNİK DETAYLAR / Details

Malzeme	: Pirinç
Yüzey Görünüm	: Krom Kaplama
Montaj	: Vidalanarak Montaj



SOHO DESIGN

Duvara Monte Işıklı Makyaj Aynası Wall Mounted Round Make-Up Mirror With Light

Kod/Code	Açıklama/Description
056704	Işıklı Makyaj Aynası Krom

TEKNİK DETAYLAR / Details

Malzeme	: Piriç
Yüzey Görünüm	: Krom Kaplama
Montaj	: Vidalanarak

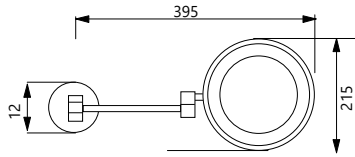

SOHO DESIGN

Duvara Monte Makaslı Makyaj Aynası Wall Mounted Round Make-Up Mirror

Kod/Code	Açıklama/Description
001088	Makaslı Makyaj Aynası 8 Inch

TEKNİK DETAYLAR / Details

Malzeme	: Piriç
Yüzey Görünüm	: Krom Kaplama
Montaj	: Vidalanarak

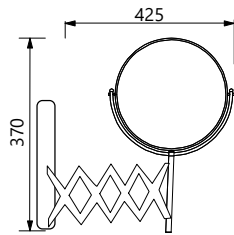

SOHO DESIGN

Duvara Monte Makyaj Aynası Wall Mounted Round Make-Up Mirror

Renk	Kod	Inch	a (mm)	b (mm)
Altın	000725	8 Inch	230	265
Krom	000723	6 Inch	215	230
	001083	8 Inch	230	265

TEKNİK DETAYLAR / Details

Malzeme	: Piriç
Yüzey Görünüm	: Krom Kaplama
Montaj	: Vidalanarak

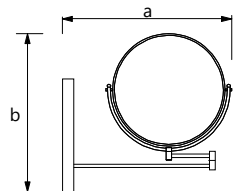



Buğu Önleyici Ayna Rezistansı

Steam Resistans Mirror

- > Doğrudan Çalışması İçin Buğu Çözücü Ayna İle Temas Halinde Olmalıdır. Buğu Çözücünün Aplik Anahtarından Enerji Alınmasını Tavsiye Ederiz. Bir Trafo veya Termostat Gerekli Değildir. Buğu Çözücü Bir Topraklama Kablosu İhtiyacını Ortadan Kaldırarak Yapılmıştır.

Kod/Code	Açıklama/Description
066780	Buğu Önleyici Ayna Rezistansı Özel Ölçü
061284	Buğu Önleyici Ayna Rezistansı 60 x 60
060950	Buğu Önleyici Ayna Rezistansı 35 x 55
061285	Buğu Önleyici Ayna Rezistansı 29 x 29

TEKNİK DETAYLAR / Details

Voltaj	: 12V, 24V, 100V - 240V, 50Hz, 60Hz
Ort. Sıcaklık Artışı	: 35° - 40°
Güç	: 200 Watts/M ²
İzaleasyon Malzemesi	: Pet
Kablo Özelliği	: 2 x 0,75 mm
Montaj	: Kendinden Yapışkanlı

ÇALIŞMA PRENSİBİ

- > Buğu Önleyici Ayna Rezistansı Bir Aynanın Arkasına Yapıştırılır ve Güç Kablosu Ana En Merkezine Bağlanır. Elektrik Enerjisi Isı Enerjisine Dönüştürülür, Aynada Buhar Yoğunlaşmasını Engeller.

BAĞLANTI

- > Çeşitli Rezistanslar Tek Bir Aynaya Monte Edilirken Paralel Olmalıdır. Bakım Sağlaması İçin Gerekli Önlemler Alınmalıdır. Pedler Üst üste Monte Edilmemelidir. Yüksek Isı Aynada Hasara Neden Olabilir.

CE Belgeli IP 54 Standartlarına Uygunluk Sertifikalıdır.

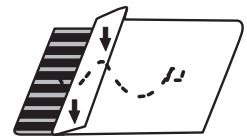
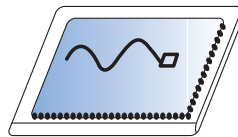
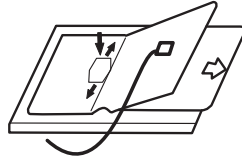
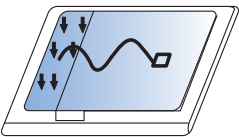
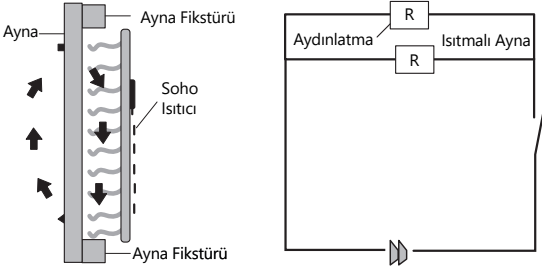

- > Aynanın Ön Yüzünün Çizilmemesi İçin Koruyucu Bir Yüzey Üzerinde Yüzü Aşağı Gelecek Şekilde Yatırın, Ayna Arka Yüzeyini Temizleyiniz
- > Kalem İle Aynanın Arkasında Soho Kısmını İşaretleyin.

- > Sohonun Yapışkan Kısmında Sarı Kaplamayı 10 cm Kaldırın ve Geriye Katlayın
- > İşaretili Kımin Başlangıcından Aynanın Arkasına Yapıştırın
- > Koruma Filmini Yavaşça Soyarak Sohonun Geri Kalan Kısmını Yapıştırarak Devam Ediniz



Gizli Kablo Kanalı
Cable Transition

Kod/Code Açıklama/Description

082349 Soho Gizli Kablo Kanalı

TEKNİK DETAYLAR / Details

Malzeme	: Çelik
Uzunluk	: 250 mm
Üst Yüzey	: Nikel
Montaj	: Kasaya Kanal Açılarak Gizli Montaj

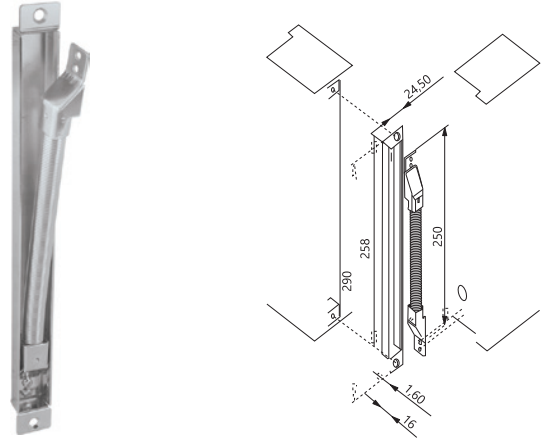

Akım Verici
Current Transmitter



Kod/Code Açıklama/Description

072767 Akım Verici Sistem

TEKNİK DETAYLAR / Details

Malzeme	: Kontak Piriç, Karşılık Plastik
Kullanım Alanı	: Kasadan Kanada Veri Aktarımı İçin
Üst Yüzey	: Kontak Nikel Kaplama, Karşılık Plastik Siyah veya Beyaz
Montaj	: Kablo Ucu, Vida Altında Sıkıştırılarak
Besleme Montajı	: ≤ 24V
Çalışma Akımı	: ≤ 1,5 A
Açma/Duraklama Süresi	: ≤ 10 Sn. / ≥ 40 Sn.
Temas Eden İki Parça Arası Uzaklık	: ≤ 5 mm

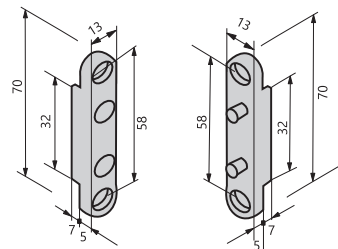

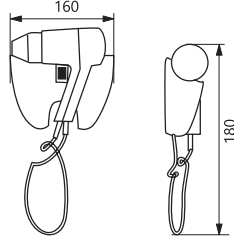

Saç Kurutma Makinası Hair Dryer

Kod/Code	Açıklama/Description
057623	Saç Kurutma Makinası

TEKNİK DETAYLAR / Details

Malzeme	: ABS
Güç	: 1200W
Özellik	: Duvara Monte, 2 Kademeli, Spiral Kablolulu
Kullanım Alanı	: Otel ve Ev Tipi

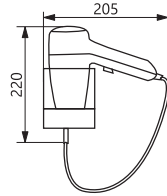

Saç Kurutma Makinası Hair Dryer

Kod/Code	Açıklama/Description
063990	Saç Kurutma Makinası

TEKNİK DETAYLAR / Details

Malzeme	: ABS
Güç	: 1200W
Özellik	: Duvara Monte, 2 Kademeli, Spiral Kablolulu
Kullanım Alanı	: Otel ve Ev Tipi

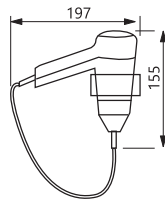

Saç Kurutma Makinası Hair Dryer

Kod/Code	Açıklama/Description
066247	Saç Kurutma Makinası

TEKNİK DETAYLAR / Details

Malzeme	: ABS
Güç	: 1600W
Özellik	: Duvara Monte, 2 Kademeli, Spiral Kablolulu
Kullanım Alanı	: Otel ve Ev Tipi

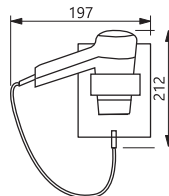

Saç Kurutma Makinası Hair Dryer

Kod/Code	Açıklama/Description
060864	Saç Kurutma Makinası

TEKNİK DETAYLAR / Details

Malzeme	: ABS
Güç	: 1200W
Özellik	: Duvara Monte, 2 Kademeli, Spiral Kablolulu
Kullanım Alanı	: Otel ve Ev Tipi

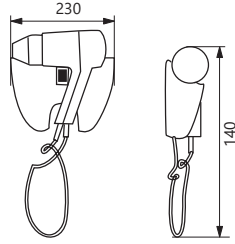

Saç Kurutma Makinası Hair Dryer

Kod/Code	Açıklama/Description
118135	Saç Kurutma Makinası

TEKNİK DETAYLAR / Details

Malzeme	: ABS
Güç	: 1400W
Özellik	: Duvara veya Çekmece İçine Monte, İyonizerli Spiral Kablolu, 2 Kademe 3 Sıcaklık Seçenekli
Kullanım Alanı	: Otel ve Ev Tipi

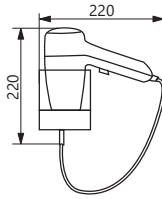

Saç Kurutma Makinası Hair Dryer

Kod/Code	Açıklama/Description
081242	Saç Kurutma Makinası

TEKNİK DETAYLAR / Details

Malzeme	: ABS
Güç	: 1400W
Özellik	: Duvara Monte, İyonizerli, 220V Taş Prizli Spiral Kablolu, 2 Kademe 3 Sıcaklık Seçenekli
Kullanım Alanı	: Otel ve Ev Tipi

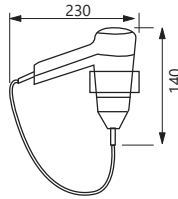

Saç Kurutma Makinası Hair Dryer

Kod/Code	Açıklama/Description
118138	Saç Kurutma Makinası

TEKNİK DETAYLAR / Details

Malzeme	: ABS
Güç	: 1875W
Özellik	: Duvara Monte, İyonizerli, 220V Taş Prizli Spiral Kablolu, 2 Kademe 3 Sıcaklık Seçenekli
Kullanım Alanı	: Otel ve Ev Tipi

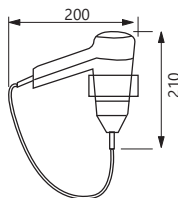

Saç Kurutma Makinası Hair Dryer

Kod/Code	Açıklama/Description
212135	Saç Kurutma Makinası

TEKNİK DETAYLAR / Details

Malzeme	: ABS
Güç	: 1400W
Özellik	: Çekmece İçi, 2 Kademeli, Spiral Kablolu
Kullanım Alanı	: Otel ve Ev Tipi

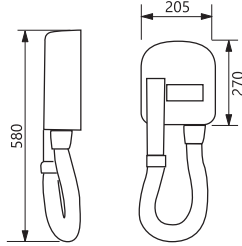

Saç Kurutma Makinası Wall Mounted Hair dryer With Hose

Hortumlu

Kod/Code	Açıklama/Description
058230	Saç Kurutma Makinası Hortumlu 700W

TEKNİK DETAYLAR / Details

Malzeme	: ABS
Güç	: 700W
Özellik	: Düşük Elektrik Tüketimi, Mika Isıtma Elemanları, Turbo Dizayn Ve Duvara Kolay Montaj 110V/220v Taş Prizli

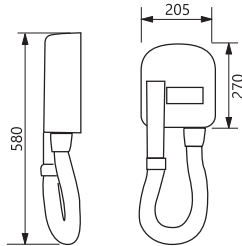

Saç Kurutma Makinası Wall Mounted Hair dryer With Hose

Hortumlu

Kod/Code	Açıklama/Description
056799	Saç Kurutma Makinası Hortumlu Dijital 1500W

TEKNİK DETAYLAR / Details

Malzeme	: ABS
Güç	: 1500W
Özellik	: 60° Başlangıç Sıcaklığı 5 Kademe Ayarlanabilir Sıcaklık Sessiz Güçlü ve Uzun Ömürlü Motor 110V/220V Taş Prizli

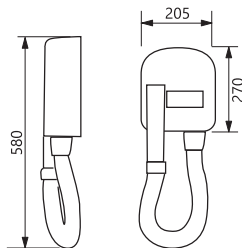

Saç Kurutma Makinası Wall Mounted Hair dryer With Hose

Hortumlu

Kod/Code	Açıklama/Description
118136	Saç Kurutma Makinası Hortumlu

TEKNİK DETAYLAR / Details

Malzeme	: ABS
Güç	: 1000W
Özellik	: Duvara Monte Taş Prizli, Hortumlu 110V/220V

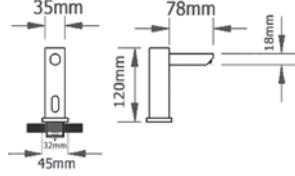

Sıvı Sabun Makinası
Photocell Liquid Soap Dispenser

Kod/Code	Açıklama/Description
237261	Sıvı Sabun Verici

TEKNİK DETAYLAR / Details

Özellik : Fotoselli Elektrikli Ankastr Sıvı Sabun Verici Prinç Gövde Üzeri Krom Kaplama

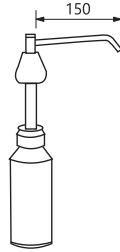

Sıvı Sabun Makinası
Liquid Soap Dispenser

Kod/Code	Açıklama/Description
008523	ABS Sıvı Sabunluk
032414	304 Çelik Sıvı Sabunluk

TEKNİK DETAYLAR / Details

Özellik : Tezgaha Ankastr Sıvı Sabunluk Gaga Uzunluğu 150 mm Hacim: 1 Litre



Tezgahüstü Sıvı Sabunluk
Counter Top Soap Dispenser

Kod/Code	Açıklama/Description
217149	Tezgahüstü Sıvı Sabunluk

TEKNİK DETAYLAR / Details

Özellik : Kare Tezgah Üstü Sıvı Sabunluk Paslanmaz Çelik 180 MI Hacim



Sıvı Sabun Makinası
Liquid Soap Dispenser

Kod/Code	Açıklama/Description
217148	Sıvı Sabun Verici

TEKNİK DETAYLAR / Details

Özellik : Duvara Monte 0,25Lt Sıvı Verici Prinç Gövde Üzeri Krom Kaplama Paslanmaz

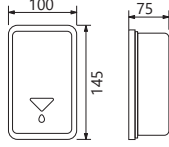

Sıvı Sabun Makinası Photocell Liquid Soap Dispenser

Kod/Code	Açıklama/Description
062438	Fotoselli Sabunluk

TEKNİK DETAYLAR / Details	
Özellik	: 304 Kalite P. Çelikten Mamül, Dayanıklı ve Darbeye Karşı Korunumlu, 4x1,5VLR6 Pille Çalışır, Estetik, Duş Jeli, Şampuan, Yıkama Losyonu vb. Kullanıma Uygun, Hırsızlık Önleyici Kilit Tertibatlı 1200 ml

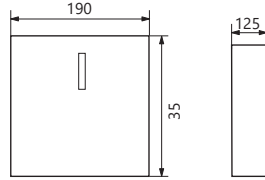

Elektrikli Sıvı Sabun Makinası Electric Liquid Soap Dispenser

Kod/Code	Açıklama/Description
141617	Elektrikli Sıvı Sabun Makinası

TEKNİK DETAYLAR / Details	
Özellik	: CPU Kontrolü, İyi Bir Parazit Önleme Özelliği Bulunan Kızılötesi Sensörlü. 0.5 ila 3m Arasında Ayarlanabilir Damlatma Hacmi. 0 (dikey) ila 30 Arasında 4 Konumda Ayarlanabilir Damlatma Yönü. DC Transformatör ile Güç Beslemesi. AC 220V-/50Hz Hareket gerilimi, DC 6V Voltaj, 12VA Anma Gücü, 2100ml Kapasite, 0.5-3.5 ml 2.3 kg Ünite Ağırlığı

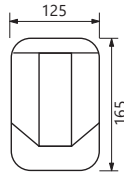

Sıvı Sabun Makinası Liquid Soap Dispenser

Kod/Code	Açıklama/Description
063994	Fotoselli ABS Sabun Verici

TEKNİK DETAYLAR / Details	
Özellik	: 800ml, 4x1.5VLR6 Pille çalışır, Duş Jeli, Şampuan, Yıkama Losyonu vb. Kullanıma Uygun Kapağı Kilitlenebilir, Estetik, Kalitel

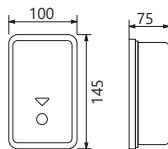

Sıvı Sabun Makinası Liquid Soap Dispenser

Kod/Code	Açıklama/Description
054063	Sıva Üstü Sıvı Sabunluk

TEKNİK DETAYLAR / Details	
Özellik	: 820 ml, Saten Görünüm, 304 Paslanmaz Çelikten Yapılmış Dayanıklı ve Darbeye Karşı Korunumlu Muhafaza; Duş Jeli, Şampuan, Yıkama Losyonu İçin Uygun, Hırsızlık Önleyici Kilitle Birlikte Kompakt Tasarım. Kapasite: 820 ml Damla: 1 ml 515x357x365 mm

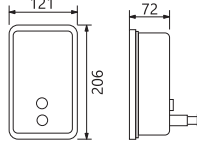

Dikey Sıvı Sabun Makinası Liquid Soap Dispenser

Kod/Code	Açıklama/Description
073599	Sıva Üstü Dikey Sıvı Sabunluk

TEKNİK DETAYLAR / Details	
Özellik	: 1000 ml, 304 Paslanmaz Çelik Butonlu 121x206x72 mm

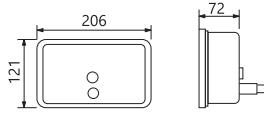

Yatay Sıvı Sabun Makinası Liquid Soap Dispenser

Kod/Code	Açıklama/Description
141619	Sıva Üstü Yatay Sıvı Sabunluk

TEKNİK DETAYLAR / Details	
Özellik	: 1000 ml, 304 Paslanmaz Çelik, Butonlu 121x206x72 mm



Köpük Verici Foam Liquid Soap Dispenser

Kod/Code	Açıklama/Description
217146	Köpük Verici

TEKNİK DETAYLAR / Details	
Özellik	: Tezgaha Monte Prinç Üzeri Krom Kaplama Fotoselli

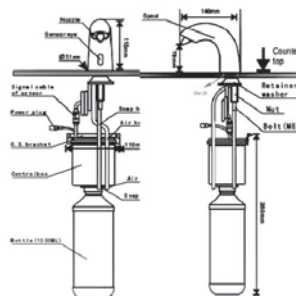

Köpük Verici Foam Liquid Soap Dispenser

Kod/Code	Açıklama/Description
216142	Köpük Verici

TEKNİK DETAYLAR / Details	
Özellik	: Fotoselli Elektrikli Paslanmaz Ankastre Köpük Verici Prinç Gövde Üzeri Krom Kaplama 1000ml

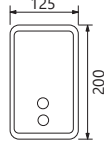

Köpük Verici Foam Soap Dispenser

Kod/Code	Açıklama/Description
217144	Köpük Verici Makina

TEKNİK DETAYLAR / Details

Özellik : 1000 ml Kapasite, 304 Paslanmaz Butonlu, Saten

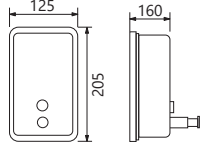

Köpük Verici Liquid Soap Dispenser

Kod/Code	Açıklama/Description
217141	Köpük Verici

TEKNİK DETAYLAR / Details

Özellik : Duvara Monte, Krom Kaplama, Çıkarılabilir Hazne, Manuel, Kilitli Kapak

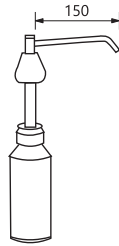

Köpük Verici Liquid Soap Dispenser

Kod/Code	Açıklama/Description
217142	Ankastre Köpük Verici

TEKNİK DETAYLAR / Details

Özellik : Paslanmaz Çelik
1000 ml



Köpük Verici Foam Soap Dispenser

Kod/Code	Açıklama/Description
217143	Köpük Verici Makina

TEKNİK DETAYLAR / Details

Özellik : Duvara Monte, Çıkarılabilir Hazne, Manuel, Kilitli Kapak, 700 ml Kapasiteli



El Kurutma Makinası Hand Dryer

Kod/Code	Açıklama/Description
088330	El Jet Kurutma Makinası

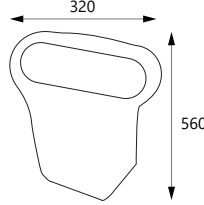

TEKNİK DETAYLAR / Details

Malzeme	: ABS
Güç	: 700W
Özellik	: Expair yeni nesil jet motorlu el kurutma makinası, Alüminyum üzeri epoxy kaplı anti bakteriyel gövde, Cooper filtre 10-15 saniye içerisinde kurutma imkanı



El Kurutma Makinası Photocell Hair Dryer

Kod/Code	Açıklama/Description
081793	Jet El Kurutma Makinası

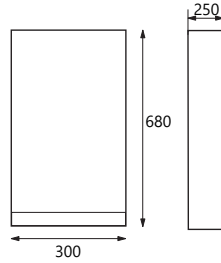

TEKNİK DETAYLAR / Details

Malzeme	: ABS
Güç	: 1400W
Özellik	: Fotoselli, High Speed Dc Brushless Jet Motorlu, Düşük Enerji Tüketimi 5-10 Sn El Kurutma, Hijyenik Filtreli, Antibakteriyel, Kapasite: 200m3/h Voltaj: 220v-240v-50hz, Güvenlik: Ip22 Hava Hızı: 110m/h Ses Seviyesi: 78db, Akım: 8A, Ağırlık: 8,5 Kg, Boyutlar: 680x300x250 Mm



El Kurutma Makinası Photocell Hair Dryer

Kod/Code	Açıklama/Description
212138	Fotoselli, El Kurutma Makinası

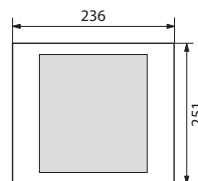

TEKNİK DETAYLAR / Details

Malzeme	: Paslanmaz
Güç	: 1000W
Özellik	: Estetik, Dayanıklı Çelik Mauhafaza. Voltaj: 220V-240V/50Hz, Akım: 5,6A Güvenlik: IPX1-CLASS I, Kapasite: 160m3/h Hava Hız: 17m/s, Ebat: 251x236x100 mm



El Kurutma Makinası Hand Dryer

Kod/Code	Açıklama/Description
056918	El Kurutma Makinası

TEKNİK DETAYLAR / Details

Malzeme	: Paslanmaz Çelik
Güç	: 2500W
Özellik	: Mükemmel Dijital Devre (PBC Kartlı) Mükemmel Parazit Giderici Özellikte Kızılötesi Sensörlü, Güçlü Hava Hızı İle 10-15 Saniyede Kurutma, Dayanıklı Darbeye Karşı Korunumlu 360° Dönen Başlıklı, Voltaj: 220V/240V/50Hz Akım: 10,9A, Güvenlik: IPX1-CLASS I Kapasite: 270m3/h Boyutlar: 270x240x200mm

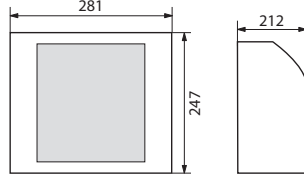

El Kurutma Makinası Hand Dryer

Kod/Code	Açıklama/Description
053925	El Kurutma Makinası

TEKNİK DETAYLAR / Details

Malzeme	: Paslanmaz Çelik
Güç	: 2500W
Özellik	: Mükemmel Dijital Devre (PBC Kartlı) Mükemmel Parazit Giderici Özellikte Kızılötesi Sensörlü, Güçlü Hava Hızı İle 10-15 Saniyede Kurutma, Dayanıklı Darbeye Karşı Korunumlu Alttan Üfleli, 360° Dönen Başlıklı, Voltaj: 220V/240V/50Hz, Akım: 10,9A, Güvenlik: IPX1-CLASS I Kapasite: 270m3/h Boyutlar: 240x200x170mm

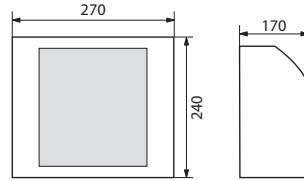

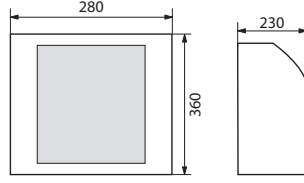

Otomatik Kağıt Havluluk

Photocell Paper Towel Dispenser

Kod/Code	Açıklama/Description
058231	Otomatik Kağıt Havluluk

TEKNİK DETAYLAR / Details

Malzeme	: Abs
Güç	: 1000W
Özellik	: Pili/Elektrikli Fotoselli 4*1,5DC Pili/Elektrikli 200-250-300 mm Uzunluk Ayarlı 21 cm Kağıt Boyu Abs Gövde Mavi ve Bal Rengi Seçenekleri

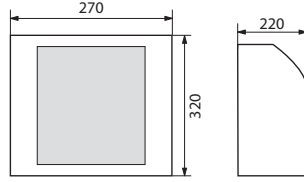

Kağıt Havluluk

Photocell Paper Towel Dispenser

Kod/Code	Açıklama/Description
214141	Otomatik Kağıt Havluluk

TEKNİK DETAYLAR / Details

Malzeme	: 304 Paslanmaz Çelik
Güç	: 1000W
Özellik	: Fotoselli Kağıt Havlu Dispenseri Sıva Altı veya Sıva Üstü Alternatifli Kilitli Kapaklı 400-200 Kağıt Kapasiteli

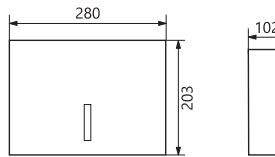
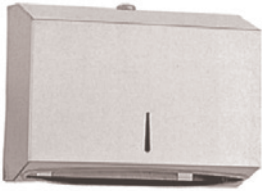

Kağıt Havluluk

Paper Towel Dispenser

Kod/Code	Açıklama/Description
008527	Kağıt Towel Holder

TEKNİK DETAYLAR / Details

Malzeme	: 304 Paslanmaz Çelik
Güç	: 1000W
Özellik	: Kağıt Havlu Dispenseri Sıva Üstü, Kilitli Kapaklı 200 Kağıt Kapasiteli

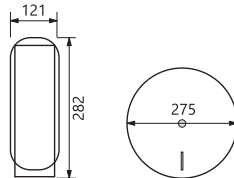

Kağıt Havluluk

Paper Towel Dispenser

Kod/Code	Açıklama/Description
060891	Kağıt Havluluk

TEKNİK DETAYLAR / Details

Malzeme	: 304 Paslanmaz Çelik
Güç	: 1000W
Ölçü	: 15x120 mm
Çap	: 200 mm

Otomatik Kağıt Havluluk

Photocell Paper Towel Dispenser

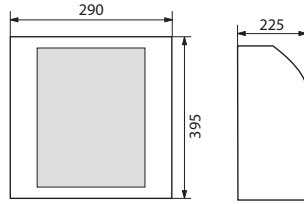

Kod/Code	Açıklama/Description
064056	Otomatik Kağıt Havluluk
TEKNİK DETAYLAR / Details	
Malzeme	: 304 Paslanmaz Çelik
Güç	: 1000W
Özellik	: Pili/Elektrikli Fotoselli 4*1,5DC Pili/Elektrikli 200-250-300 mm Uzunluk Ayarlı 21 cm Kağıt Boyu 304 Paslanmaz Çelik Gövde

Kağıt Havluluk

Paper Towel Dispenser

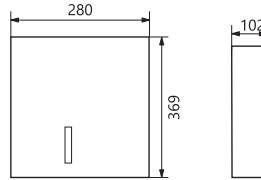

Kod/Code	Açıklama/Description
008526	Otomatik Kağıt Havluluk
TEKNİK DETAYLAR / Details	
Malzeme	: 304 Paslanmaz Çelik
Güç	: 1000W
Özellik	: 400 Kağıt Kapasiteli

Kağıt Havluluk

Paper Towel Dispenser

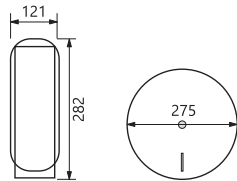

Kod/Code	Açıklama/Description
063992	Kağıt Towel Holder
TEKNİK DETAYLAR / Details	
Malzeme	: 304 Paslanmaz Çelik
Güç	: 1000W
Özellik	: Farklı Kağıt Ruloları İçin 43mm ve 54 mm Çapta Olmak Üzer İki Gövde Çubuğu. Kağıt Boyutu: Çap 250mm, Genişlik 100mm

Klozet Kapak Kağıt Dispenser

Toilet Stat Cover Dispenser

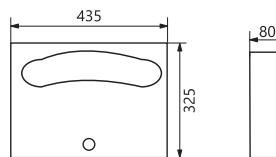

Kod/Code	Açıklama/Description
008536	Kağıt Havluluk
TEKNİK DETAYLAR / Details	
Malzeme	: 304 Paslanmaz Çelik
Ölçü	: 390x270x60 mm

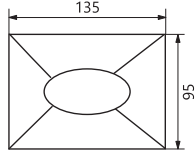

Ped Poşet Kutusu

Tissue Box

Kod/Code	Açıklama/Description
073719	Ped Poşet Kutusu
TEKNİK DETAYLAR / Details	
Malzeme	: 304 Paslanmaz Çelik
Özellik	: Kağıt Havlu Dispenseri Sıva Üstü, Kilitli Kapaklı 400 Kağıt Kapasiteli

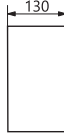
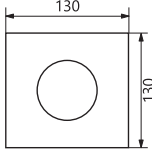

Kağıt Mendil Kutusu

Tissue Box

Kod/Code	Açıklama/Description
061228	Kare Kağıt Mendil Kutusu
TEKNİK DETAYLAR / Details	
Malzeme	: Abs Gövde, Krom Kaplama
Özellik	: Tezgah Üstü 130x130x130mm

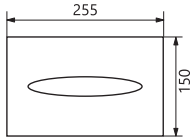

Kağıt Mendil Kutusu

Tissue Box

Kod/Code	Açıklama/Description
061227	Kağıt Mendil Kutusu
TEKNİK DETAYLAR / Details	
Malzeme	: Abs Gövde, Krom Kaplama
Özellik	: Tezgah Üstü 255x150x60mm

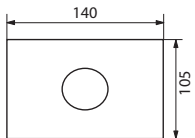

Kağıt Mendil Kutusu

Tissue Box

Kod/Code	Açıklama/Description
070030	Kağıt Mendil Kutusu
TEKNİK DETAYLAR / Details	
Malzeme	: 304 Paslanmaz, Krom Kaplama
Özellik	: Tezgah Üstü 140x105x35mm

Kombi Sistemi

Combination Towel / Handdryer / Waste Units

Kod/Code	Açıklama/Description
215144	Kombi Sistemi

TEKNİK DETAYLAR / Details

Malzeme	: 304 Paslanmaz Çelik
Özellik	: Sıva Üstü/Ankastre, Fotoselli Kağıt Verici 200,250,300mm Ayarlanabilir K.boyu 21cm Rulo Çapı 21cm Kağıt Geniřliđi El Kurutmalı 2500w Gücünde, 23 Litre Tařınabilir Çöp Kovası 21,5 kg Ađırlık Y.G.D. 1600X320X150(225)mm



Ankastre
Fotoselli

3'lü Kombinasyon

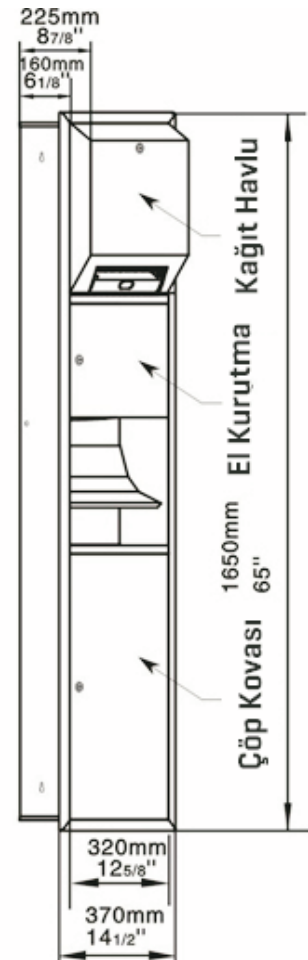



Sıva Üstü
Fotoselli

Kombi Sistemi

Combination Photocell Paper Towel Dispenser With Waste Units

Kod/Code	Açıklama/Description
062767	Kombi Sistemi

TEKNİK DETAYLAR / Details

Malzeme	: 304 Paslanmaz Çelik
Özellik	: Sıva Üstü/Ankastre, Fotoselli Kağıt Verici 200,250,300mm Ayarlanabilir K.boyu 21cm Rulo Çapı 21cm Kağıt Geniřliđi El Kurutmalı 2500w Gücünde, 23 Litre Tařınabilir Çöp Kovası 12,2 kg Ađırlık Y.G.D. 1250X320X150(225)mm

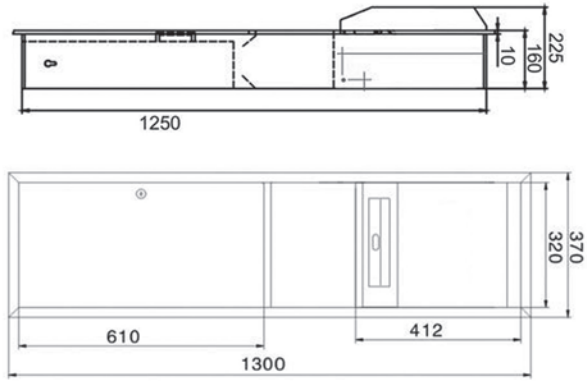

Kombi Sistemi

Combination Photocell Paper Towel Dispenser With Waste Units

Kod/Code	Açıklama/Description
057990	Kombi Sistemi

TEKNİK DETAYLAR / Details

Malzeme	: 304 Paslanmaz Çelik
Özellik	: Sıva Üstü/Ankastre, Fotoselli Kağıt Verici 200,250,300mm Ayarlanabilir K.boyu 21cm Rulo Çapı 21cm Kağıt Geniřliđi El Kurutmalı 2500w Gücünde, 23 Litre Tařınabilir Çöp Kovası 12,2 kg Ađırlık Y.G.D. 1250X320X150(225)mm



Ankastre
Fotoselli

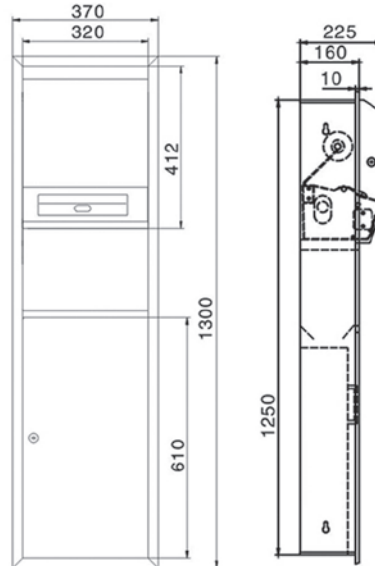

Kombi Sistemi

Combination Paper Towel Dispenser With Waste Units



Ankastre

Kod/Code	Açıklama/Description
215142	Kombi Sistemi

TEKNİK DETAYLAR / Details

Malzeme	: 304 Paslanmaz Çelik
Özellik	: Ankastre, 400 Adet Z Kağıt Verici, 8L Taşınabilir Çöp Kovası 710x335x100mm

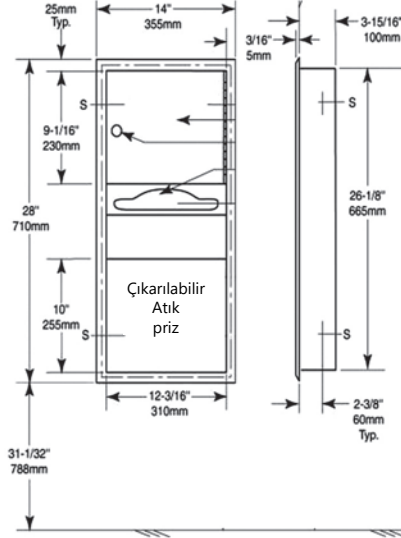

Kombi Sistemi

Combined System



Sıva Üstü

Kod/Code	Açıklama/Description
215143	Kombi Sistemi

TEKNİK DETAYLAR / Details

Malzeme	: 304 Paslanmaz Çelik
Özellik	: Ankastre, 400 Adet Z Kağıt Verici, 8L Taşınabilir Çöp Kovası 710x335x100mm

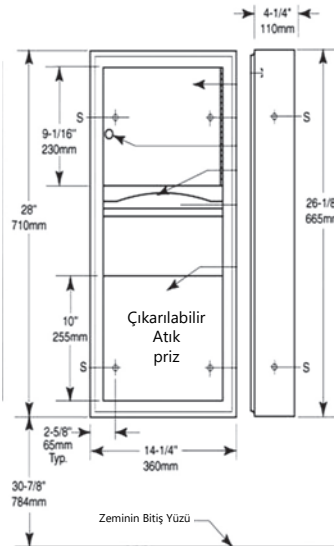

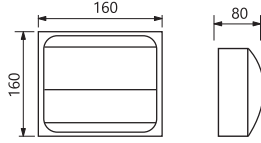

Tekli Ankastru Tuvalet Kağıtlık

Built in Toilet Paper Holder

Kod/Code	Açıklama/Description
213140	Soho Sıva Altı WC Kağıtlık

TEKNİK DETAYLAR / Details

Malzeme	: 304 Paslanmaz Çelik
Ölçü	: 160x160x80 mm

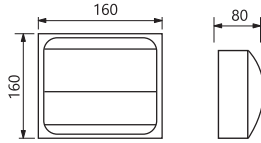

Tekli Sıva Üstü Tuvalet Kağıtlık

Toilet Paper Holder

Kod/Code	Açıklama/Description
073727	Soho Tekli Sıva Üstü WC Kağıtlık

TEKNİK DETAYLAR / Details

Malzeme	: 304 Paslanmaz Çelik
Ölçü	: 160x160x80 mm

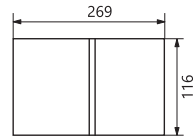

İkili Tuvalet Kağıtlık

Double Toilet Paper Holder

Kod/Code	Açıklama/Description
000746	Soho İkili WC Kağıtlık

TEKNİK DETAYLAR / Details

Malzeme	: 304 Paslanmaz Çelik
Ölçü	: 270x100x115 mm

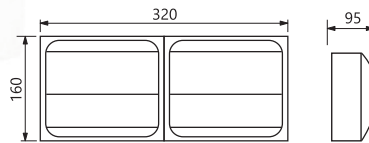

İkili Sıva Üstü Tuvalet Kağıtlık

Double Toilet Paper Holder

Kod/Code	Açıklama/Description
073728	Soho İkili Sıva Üstü WC Kağıtlık

TEKNİK DETAYLAR / Details

Malzeme	: 304 Paslanmaz Çelik
Ölçü	: 320x160x95mm

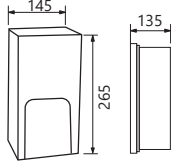

Tekli Ankastru Tuvalet Kağıtlık

Built in Toilet Paper Holder

Kod/Code	Açıklama/Description
141620	Soho Sıva Altı WC Kağıtlık

TEKNİK DETAYLAR / Details

Malzeme	: 304 Paslanmaz Çelik
Ölçü	: 145x265x130 mm

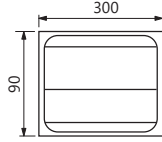
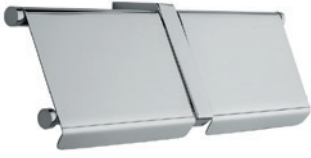

İkili Tuvalet Kağıtlık

Double Toilet Paper Holder

Kod/Code	Açıklama/Description
120306	Soho İkili WC Kağıtlık

TEKNİK DETAYLAR / Details

Malzeme	: Prinç Metal
Ölçü	: 300x100x55 mm

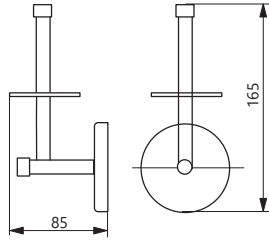

Yedek Tuvalet Kağıtlık

Spare Toilet Paper Holder

Kod/Code	Açıklama/Description
063147	Soho WC Kağıtlık Dikeylet Kağıtlık

TEKNİK DETAYLAR / Details

Malzeme	: Prinç Krom
Ölçü	: 85x165 mm

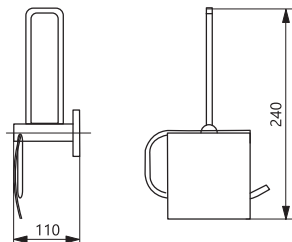

Kapaklı Yedek Kağıtlık

Spare Toilet Paper Holder With Cover

Kod/Code	Açıklama/Description
073731	Soho Yedekli WC Kağıtlık

TEKNİK DETAYLAR / Details

Malzeme	: Prinç Krom
Ölçü	: 110x240 mm



Süngerlik/Sabunluk
Sponge Holder

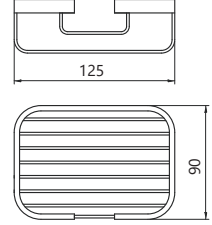

Kod/Code	Açıklama/Description
224205	Süngerlik - Sabunluk

TEKNİK DETAYLAR / Details

Malzeme	: 304 Paslanmaz
Yüzey Görünüm	: Krom Kaplama
Montaj	: Vidalanarak

Süngerlik/Sabunluk
Sponge Holder

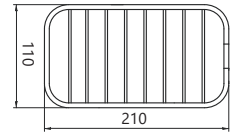
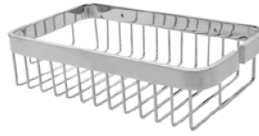

Kod/Code	Açıklama/Description
224206	Sponge Holder

TEKNİK DETAYLAR / Details

Malzeme	: 304 Paslanmaz
Yüzey Görünüm	: Krom Kaplama
Montaj	: Vidalanarak

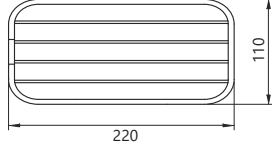

Süngerlik/Sabunluk

Sponge Holder

Kod/Code	Açıklama/Description
160808	Süngerlik - Sabunluk

TEKNİK DETAYLAR / Details

Malzeme	: 304 Paslanmaz
Yüzey Görünüm	: Krom Kaplama
Montaj	: Vidalanarak Montaj

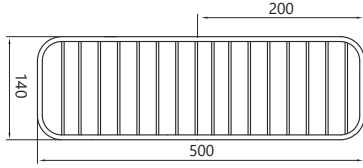

Süngerlik/Sabunluk

Sponge Holder

Kod/Code	Açıklama/Description
224207	Süngerlik - Sabunluk

TEKNİK DETAYLAR / Details

Malzeme	: 304 Paslanmaz
Yüzey Görünüm	: Krom Kaplama
Montaj	: Vidalanarak Montaj

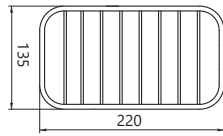

Süngerlik/Sabunluk

Sponge Holder

Kod/Code	Açıklama/Description
160807	Süngerlik - Sabunluk

TEKNİK DETAYLAR / Details

Malzeme	: 304 Paslanmaz
Yüzey Görünüm	: Krom Kaplama
Montaj	: Vidalanarak Montaj

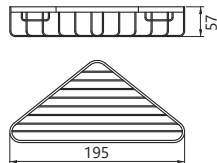

Süngerlik/Sabunluk

Sponge Holder

Kod/Code	Açıklama/Description
224208	Süngerlik - Sabunluk

TEKNİK DETAYLAR / Details

Malzeme	: 304 Paslanmaz
Yüzey Görünüm	: Krom Kaplama
Montaj	: Vidalanarak Montaj

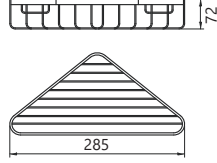

Süngerlik/Sabunluk Sponge Holder

Kod/Code	Açıklama/Description
224209	Süngerlik - Sabunluk

TEKNİK DETAYLAR / Details

Malzeme	: 304 Paslanmaz
Yüzey Görünüm	: Krom Kaplama
Montaj	: Yerden

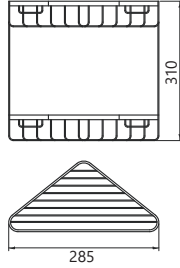

Süngerlik/Sabunluk Sponge Holder

Kod/Code	Açıklama/Description
224210	Süngerlik - Sabunluk

TEKNİK DETAYLAR / Details

Malzeme	: 304 Paslanmaz
Yüzey Görünüm	: Krom Kaplama
Montaj	: Yerden

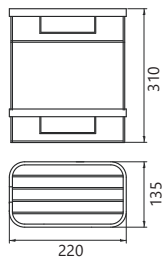

Süngerlik/Sabunluk Sponge Holder

Kod/Code	Açıklama/Description
224211	Süngerlik - Sabunluk

TEKNİK DETAYLAR / Details

Malzeme	: 304 Paslanmaz
Yüzey Görünüm	: Krom Kaplama
Montaj	: Vidalanarak Montaj

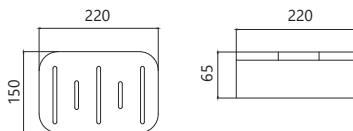

Süngerlik/Sabunluk Sponge Holder

Kod/Code	Açıklama/Description
224212	Süngerlik - Sabunluk

TEKNİK DETAYLAR / Details

Malzeme	: 304 Paslanmaz
Yüzey Görünüm	: Krom Kaplama
Montaj	: Yerden

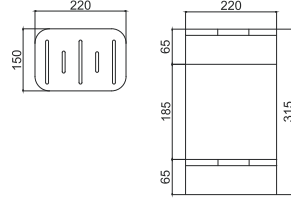

Süngerlik/Sabunluk Sponge Holder

Kod/Code	Açıklama/Description
224213	Süngerlik - Sabunluk

TEKNİK DETAYLAR / Details

Malzeme	: 304 Paslanmaz
Yüzey Görünüm	: Krom Kaplama
Montaj	: Yerden

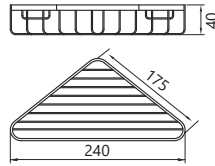

Süngerlik/Sabunluk Sponge Holder

Kod/Code	Açıklama/Description
232202	Süngerlik - Sabunluk

TEKNİK DETAYLAR / Details

Malzeme	: 304 Paslanmaz
Yüzey Görünüm	: Krom Kaplama
Montaj	: Yerden

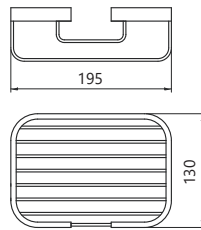

Süngerlik/Sabunluk Sponge Holder

Kod/Code	Açıklama/Description
067213	Süngerlik - Sabunluk

TEKNİK DETAYLAR / Details

Malzeme	: 304 Paslanmaz
Yüzey Görünüm	: Krom Kaplama
Montaj	: Vidalanarak Montaj

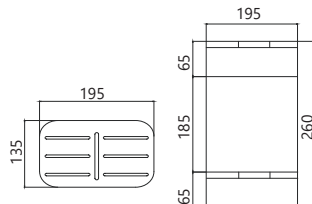

Süngerlik/Sabunluk Sponge Holder

Kod/Code	Açıklama/Description
067214	Süngerlik - Sabunluk

TEKNİK DETAYLAR / Details

Malzeme	: 304 Paslanmaz
Yüzey Görünüm	: Krom Kaplama
Montaj	: Yerden

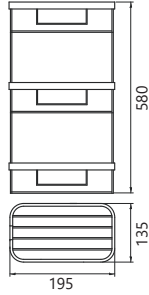

Süngerlik/Sabunluk Sponge Holder

Kod/Code	Açıklama/Description
224214	Süngerlik - Sabunluk

TEKNİK DETAYLAR / Details

Malzeme	: 304 Paslanmaz
Yüzey Görünüm	: Krom Kaplama
Montaj	: Yerden

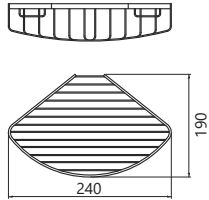

Süngerlik/Sabunluk Sponge Holder

Kod/Code	Açıklama/Description
160816	Süngerlik - Sabunluk

TEKNİK DETAYLAR / Details

Malzeme	: 304 Paslanmaz
Yüzey Görünüm	: Krom Kaplama
Montaj	: Yerden

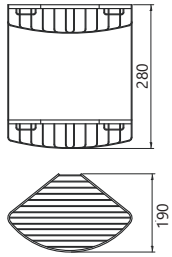

Süngerlik/Sabunluk Sponge Holder

Kod/Code	Açıklama/Description
160817	Süngerlik - Sabunluk

TEKNİK DETAYLAR / Details

Malzeme	: 304 Paslanmaz
Yüzey Görünüm	: Krom Kaplama
Montaj	: Vidalanarak Montaj

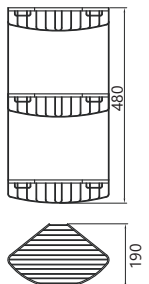

Süngerlik/Sabunluk Sponge Holder

Kod/Code	Açıklama/Description
224215	Süngerlik - Sabunluk

TEKNİK DETAYLAR / Details

Malzeme	: 304 Paslanmaz
Yüzey Görünüm	: Krom Kaplama
Montaj	: Yerden

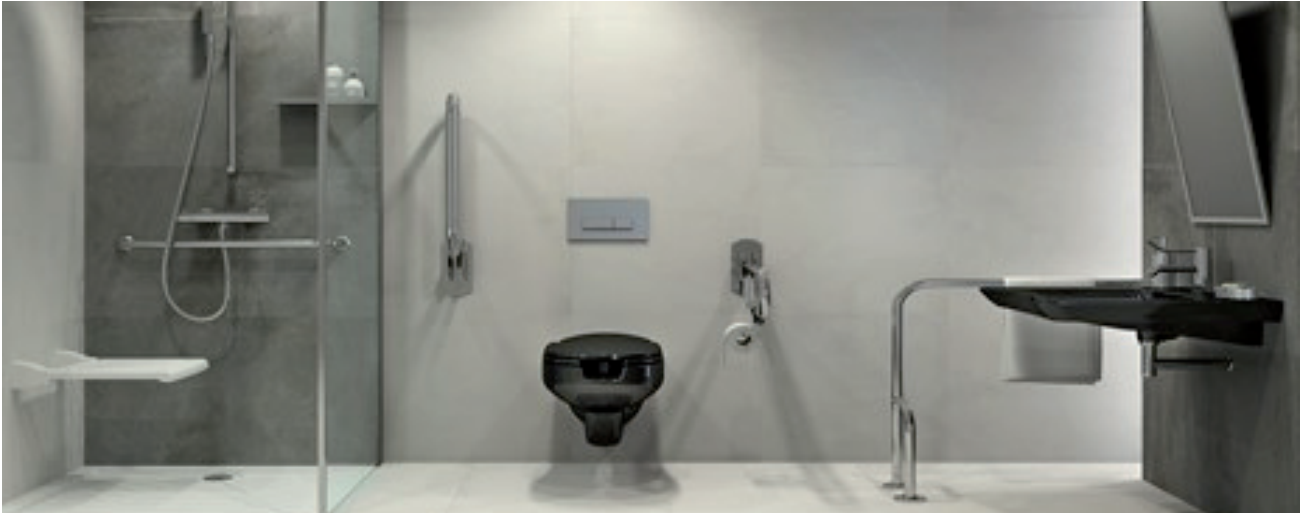

Açılı Küvet Tutamağı Grab Bar

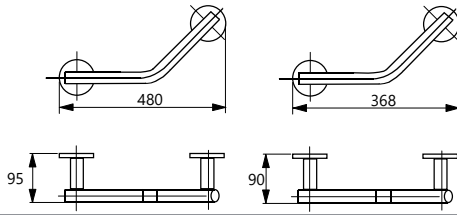

Kod/Code	Açıklama/Description
073737	Açılı Küvet Tutamağı Ø20 2001
064126	Açılı Küvet Tutamağı Küçük Ø20 2001 01

TEKNİK DETAYLAR / Details

Malzeme	: Pirinç
Üst Yüzey	: Krom Kaplama
Montaj	: Vidalanarak



Küvet Tutamağı Grab Bar

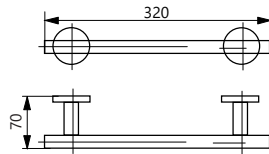

Kod/Code	Açıklama/Description
066470	Küvet Tutamağı 300 mm - Ø20 2006

TEKNİK DETAYLAR / Details

Malzeme	: Pirinç
Üst Yüzey	: Krom Kaplama
Montaj	: Vidalanarak



Süngerlikli Küvet Tutamağı Grab Bar With Sponge Holder

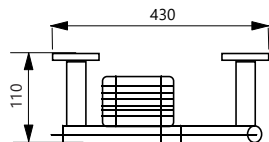

Kod/Code	Açıklama/Description
000741	Süngerlikli Küvet Tutamağı Krom

TEKNİK DETAYLAR / Details

Malzeme	: Pirinç
Üst Yüzey	: Krom Kaplama
Montaj	: Vidalanarak

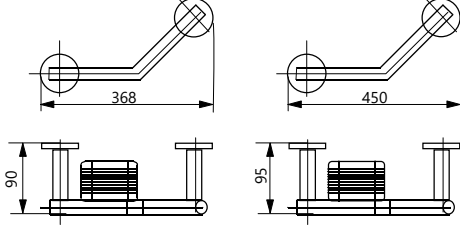

Süngerlikli Küvet Tutamağı

Grab Bar With Spange Holder

Kod/Code	Açıklama/Description
072742	Süngerlikli Küvet Tutamağı Ø20 2002
064125	Süngerlikli Küvet Tutamağı Küçük Ø20 2002 01

TEKNİK DETAYLAR / Details

Malzeme	: Pirinç
Üst Yüzey	: Krom Kaplama
Montaj	: Vidalanarak

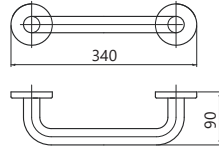

Küvet Tutamağı 30 cm

Grab Bar

Kod/Code	Açıklama/Description
224224	Küvet Tutamağı 30cm

TEKNİK DETAYLAR / Details

Malzeme	: 304 Paslanmaz
Yüzey Görünüm	: Krom Kaplama
Montaj	: Vidalanarak Montaj

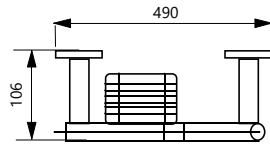
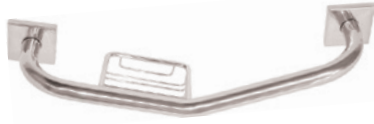

Süngerlikli Küvet Tutamağı

Grab Bar With Spange Holder

Kod/Code	Açıklama/Description
060891	Soho Süngerlikli Küvet Tutamağı

TEKNİK DETAYLAR / Details

Malzeme	: 304 Paslanmaz Çelik
Üst Yüzey	: Krom Kaplama
Montaj	: Vidalanarak

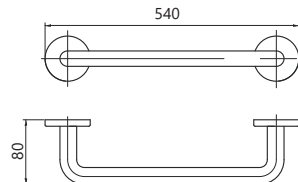

Küvet Tutamağı

Grab Bar

Kod/Code	Açıklama/Description
224225	Küvet Tutamağı 50cm

TEKNİK DETAYLAR / Details

Malzeme	: 304 Paslanmaz
Yüzey Görünüm	: Krom Kaplama
Montaj	: Yerden





Ayaklı Wc. Fırçalık-Kağıtlık Set
Free-Standing Toilet Roll And Brush Holder

Kod/Code	Açıklama/Description
224203	Ayaklı Wc. Fırçalık-Kağıtlık Set

TEKNİK DETAYLAR / Details

Malzeme	: 304 Paslanmaz
Yüzey Görünüm	: Krom Kaplama
Montaj	: Yerden



Ayaklı Wc. Fırçalık-Kağıtlık Set
Free-Standing Toilet Roll And Brush Holder

Kod/Code	Açıklama/Description
224204	Ayaklı Wc. Fırçalık-Kağıtlık Set

TEKNİK DETAYLAR / Details

Malzeme	: 304 Paslanmaz
Yüzey Görünüm	: Krom Kaplama
Montaj	: Yerden



Ayaklı Wc. Fırçalık-Kağıtlık Set
Free-Standing Toilet Roll And Brush Holder

Kod/Code	Açıklama/Description
224201	Ayaklı Wc. Fırçalık-Kağıtlık Set

TEKNİK DETAYLAR / Details

Malzeme	: 304 Paslanmaz
Yüzey Görünüm	: Krom Kaplama
Montaj	: Yerden



Ayaklı Wc. Fırçalık-Kağıtlık Set
Free-Standing Toilet Roll And Brush Holder

Kod/Code	Açıklama/Description
224202	Ayaklı Wc. Fırçalık-Kağıtlık Set

TEKNİK DETAYLAR / Details

Malzeme	: 304 Paslanmaz
Yüzey Görünüm	: Krom Kaplama
Montaj	: Yerden

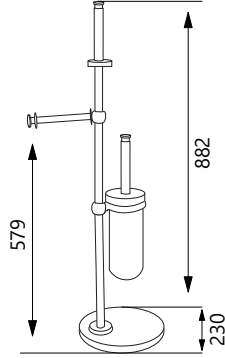

Ayaklı Klozet Fırçalık ve Tuvalet Kağıtlık Free-Standing Toilet Roll And Brush Holder

Kod/Code	Açıklama/Description
320930	Ekselans Ayaklı Klozet Fırçalık ve Tuvalet Kağıtlık

TEKNİK DETAYLAR / Details	
Malzeme	: Pirinç
Yüzey Görünüm	: Antik
Montaj	: Yerden

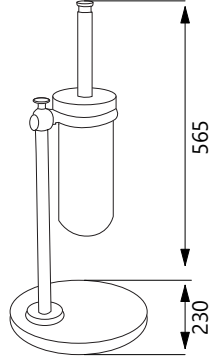

Ayaklı Klozet Fırçalık Free-Standing Toilet Brush Holder

Kod/Code	Açıklama/Description
327929	Ekselans Ayaklı Klozet Fırçalık

TEKNİK DETAYLAR / Details	
Malzeme	: Pirinç
Yüzey Görünüm	: Antik
Montaj	: Yerden

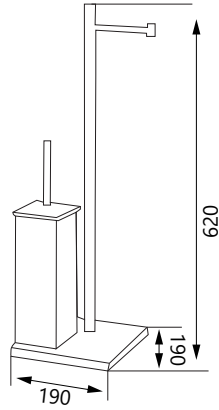

Ayaklı Wc. Fırçalık-Kağıtlık Set Free-Standing Toilet Roll And Brush Holder

Kod/Code	Açıklama/Description
120343	Ayaklı Wc. Fırçalık-Kağıtlık Set

TEKNİK DETAYLAR / Details	
Malzeme	: 304 Paslanmaz
Yüzey Görünüm	: Krom Kaplama
Montaj	: Yerden

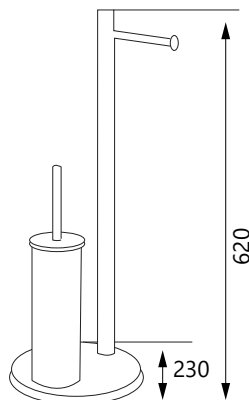

Ayaklı Wc. Fırçalık-Kağıtlık Set Free-Standing Toilet Roll And Brush Holder

Kod/Code	Açıklama/Description
119250	Ayaklı Wc. Fırçalık-Kağıtlık Set

TEKNİK DETAYLAR / Details	
Malzeme	: 304 Paslanmaz
Yüzey Görünüm	: Krom Kaplama
Montaj	: Yerden



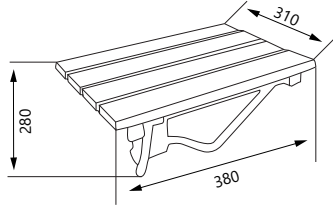

Duşakabin Oturağı
Wall Mounted Shower Stool

Kod/Code	Açıklama/Description
089880	Duşakabin Oturağı

TEKNİK DETAYLAR / Details

Malzeme	: 304 Paslanmaz
Açıklama	: Katlanabilir banyo oturağı. Max 120kg Oturarak boyutları 380 x 310mm
Montaj	: Duvara Montaj

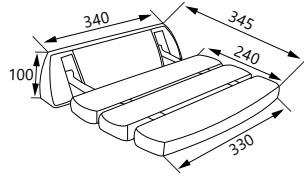

Duşakabin Oturağı
Wall Mounted Shower Stool

Kod/Code	Açıklama/Description
057236	Duşakabin Oturağı

TEKNİK DETAYLAR / Details

Malzeme	: 304 Paslanmaz
Açıklama	: Katlanabilir ve banyo oturağı. Max 120kg Oturarak boyutları 350 x 250mm
Montaj	: Duvara Montaj



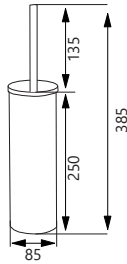

Yuvarlak Klozet Fırçalık Toilet Brush



Kod/Code	Açıklama/Description
120386	Soho Yuvarlak Fırçalık Krom
140576	Soho Yuvarlak Fırçalık Saten
141577	Soho Yuvarlak Fırçalık Mat Siyah

TEKNİK DETAYLAR / Details

Malzeme	: 304 Paslanmaz
Yüzey Görünüm	: Krom, Saten, Mat Siyah, Altın, Bakır
Montaj	: Yerden veya Duvara Montaj

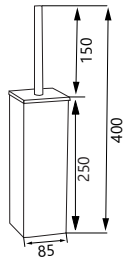

Kare Klozet Fırçalık Toilet Brush



Kod/Code	Açıklama/Description
120384	Soho Kare Klozet Fırçalık Krom
141578	Soho Kare Klozet Fırçalık Saten
141581	Soho Kare Klozet Fırçalık Mat Siyah

TEKNİK DETAYLAR / Details

Malzeme	: 304 Paslanmaz
Yüzey Görünüm	: Krom, Saten, Mat Siyah, Altın, Bakır
Montaj	: Yerden veya Duvara Montaj

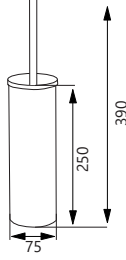

Yuvarlak Klozet Fırçalık Free-Standing Toilet Brush

Kod/Code	Açıklama/Description
071609	Yuvarlak Klozet Fırçalık Saten

TEKNİK DETAYLAR / Details

Malzeme	: 304 Paslanmaz
Yüzey Görünüm	: Krom Kaplama
Montaj	: Yerden

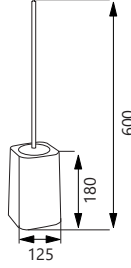

Klozet Fırçalık Free-Standing Toilet Brush

Kod/Code	Açıklama/Description
082250	Klozet Fırçalık

TEKNİK DETAYLAR / Details

Malzeme	: 304 Paslanmaz
Yüzey Görünüm	: Krom Kaplama
Montaj	: Yerden

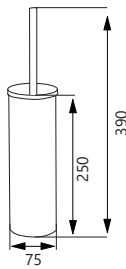

Yuvarlak Klozet Fırçalık Free-Standing Toilet Brush

Kod/Code	Açıklama/Description
224200	Yuvarlak Klozet Fırçalık

TEKNİK DETAYLAR / Details

Malzeme	: 304 Paslanmaz
Yüzey Görünüm	: Krom Kaplama
Montaj	: Vidalanarak Montaj

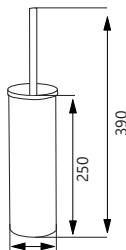

Yuvarlak Klozet Fırçalık Free-Standing Toilet Brush

Kod/Code	Açıklama/Description
224229	Yuvarlak Klozet Fırçalık

TEKNİK DETAYLAR / Details

Malzeme	: 304 Paslanmaz
Yüzey Görünüm	: Krom Kaplama
Montaj	: Yerden

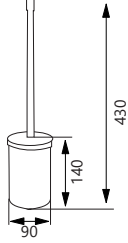

Teleskopik Klozet Fırçalık

Free-Standing Toilet Brush With Telescopic Handle

Kod/Code	Açıklama/Description
089848	Teleskopik Klozet Fırçalık

TEKNİK DETAYLAR / Details

Malzeme	: 304 Paslanmaz
Yüzey Görünüm	: Krom Kaplama
Montaj	: Yerden

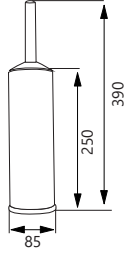

Yuvarlak Klozet Fırçalık

Free-Standing Toilet Brush

Kod/Code	Açıklama/Description
119037	Yuvarlak Klozet Fırçalık

TEKNİK DETAYLAR / Details

Malzeme	: 304 Paslanmaz
Yüzey Görünüm	: Krom Kaplama
Montaj	: Yerden

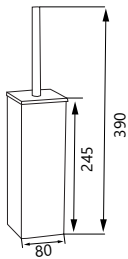

Kare Klozet Fırçalık

Free-Standing Toilet Brush

Kod/Code	Açıklama/Description
224228	Kare Klozet Fırçalık

TEKNİK DETAYLAR / Details

Malzeme	: 304 Paslanmaz
Yüzey Görünüm	: Krom Kaplama
Montaj	: Yerden

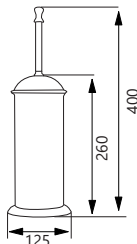

Biyeli Klozet Fırçalık

Free-Standing Toilet Brush

Kod/Code	Açıklama/Description
001179	Biyeli Klozet Fırçalık Altın
118662	Biyeli Klozet Fırçalık Antik

TEKNİK DETAYLAR / Details

Malzeme	: 304 Paslanmaz
Yüzey Görünüm	: Krom Kaplama
Montaj	: Yerden





Açılı Tutunma Barı - 2018 Seri
Grab Bar

Kod/Code	Açıklama/Description
072327	Açılı Tutunma Barı

TEKNİK DETAYLAR / Details

Malzeme	: 304 Paslanmaz Çelik, Mat
Özellik	: 45° Açılı

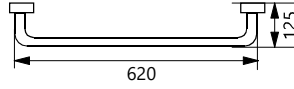

Tutunma Barı - 2017 Seri
Grab Bar

Kod/Code	Açıklama/Description
071272	Tutunma Barı 600 mm
072329	Tutunma Barı 500 mm
072330	Tutunma Barı 400 mm

TEKNİK DETAYLAR / Details

Malzeme	: 304 Paslanmaz Çelik, Mat
Ölçü	: 600 mm Uzunluk
> Teknik Çizim 600 mm İçin Hazırlanmıştır.	

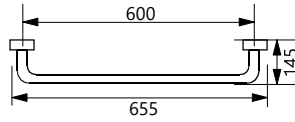

Tutamak - A190 Seri
Grab Bar

Kod/Code	Açıklama/Description
072328	A190 Tutamak

TEKNİK DETAYLAR / Details

Malzeme	: 304 Paslanmaz Çelik, Mat
Özellik	: Banyo Küvet Kenarı

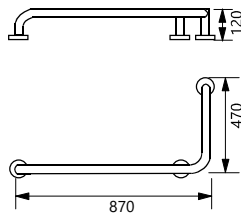

Köşe Tutunma Barı - A403 Seri
Grab Bar

Kod/Code	Açıklama/Description
072331	Açılı Köşe Tutunma Barı A403

TEKNİK DETAYLAR / Details

Malzeme	: 304 Paslanmaz Çelik, Mat
Özellik	: Banyo Küvet Kenarı

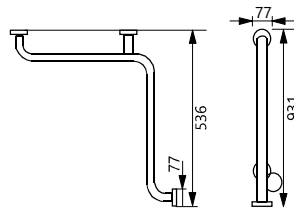



Hareketli Tutunma Barı - 2014 Seri Swing Grab Bar

Kod/Code	Açıklama/Description
072332	Hareketli Tutunma Barı 2014

TEKNİK DETAYLAR / Details

Malzeme	: 304 Paslanmaz Çelik, Mat
Özellik	: Tablalı Hareketli
Ölçü	: 760 x 265 mm

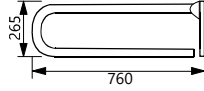

A140 Sağ/A150 Sol Tutamak - 2012 Seri Grab Bar

Kod/Code	Açıklama/Description
070837	Seri Tutunma Barı Sağ
072333	Seri Tutunma Barı Sol

TEKNİK DETAYLAR / Details

Malzeme	: 304 Paslanmaz Çelik, Mat
Özellik	: Yerden Duvara
Ölçü	: 740 x 740 mm

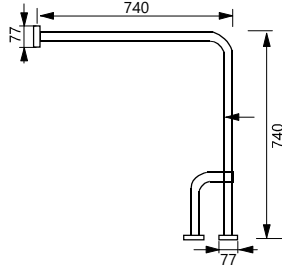

Duş Oturağı - 220 Seri Shower Stool

Kod/Code	Açıklama/Description
053864	Duş Oturağı 220

TEKNİK DETAYLAR / Details

Malzeme	: 304 Paslanmaz Çelik + Plastik
Özellik	: Duvara Monte, Hareketli
Ölçü	: 430 x 380 mm

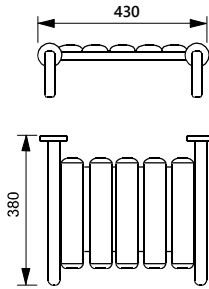

Yatay Tutunma Barı Sağ/Sol - 7006 Seri Horizontal Grab Bar Left / Right

Kod/Code	Açıklama/Description
070286	Yatay Tutunma Barı Sağ/Sol 7006

TEKNİK DETAYLAR / Details

Malzeme	: Paslanmaz Çelik, Mat
Montaj	: Duvara Monte, Vidalanarak
Ölçü	: 400 x 800 mm

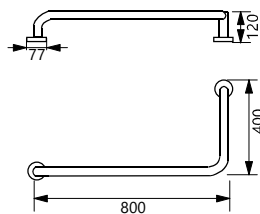



Mafsallı Tutunma Bari Kağıtlık

7008-1

Grab Bar With Toilet Holder

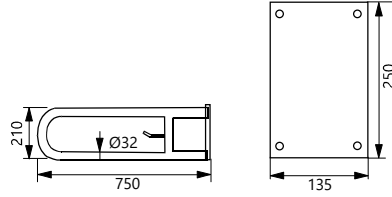

Kod/Code	Açıklama/Description
070284	Mafsalı Tutunma Bari Kağıtlık 7008-1

TEKNİK DETAYLAR / Details

Malzeme	: 304 Paslanmaz Çelik, Mat
Özellik	: Hareketli, Duvara Monte Vidalanarak

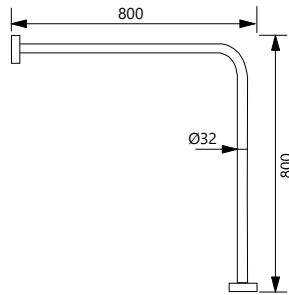

Yerden Duvara L Tutunma Bari

7004

Grab Bar Ltype

Kod/Code	Açıklama/Description
070285	Yerden Duvara L Tutunma Bari 7004

TEKNİK DETAYLAR / Details

Malzeme	: 304 Paslanmaz Çelik, Mat
Özellik	: Duvara Monte, Vidalanarak

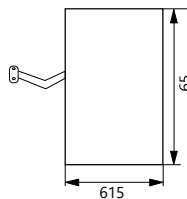
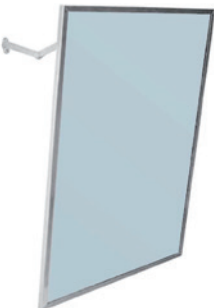

Ayarlanabilir Ayna

7001

Adjustable Mirror

Kod/Code	Açıklama/Description
063916	Ayarlanabilir Ayna 7001

TEKNİK DETAYLAR / Details

Malzeme	: 304 Paslanmaz Çelik + Cam Ayna
Özellik	: Duvara Monte, Hareketli



Elektronik Şifreli Kabin Kilidi
Electronic Cabinet Lock



Türkiyenin **TEK** Sertifikalı
Kabin Kilidi

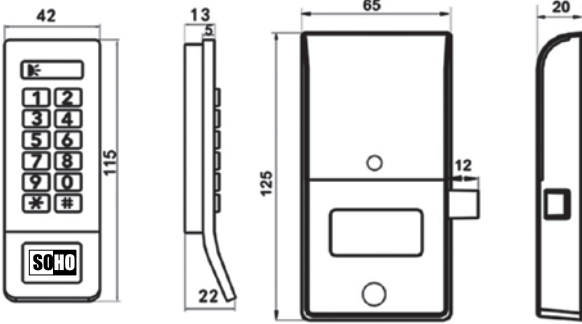

Kod/Code	Açıklama/Description
120364	Soho Şifreli Kabin Kilidi Paslanmaz Saten
135548	Soho Şifreli Kabin Kilidi Yedek Pil Kabini
130495	Soho Şifreli Kabin Kilidi Master Kart

KURULUM AÇIKLAMA

- > 3 Adet Alkalin Pili Yerine Yerleştiriniz
- > Arka Paneldek Kordon Fişi Ön Paneldeki Prizi Yerleştiriniz
- > 3 Uzun Bip Sesi Gelinceye Kadar Re-set Butonuna Basınız
- > Kartınızı Ön Panelde Bulunan Siyah (SOHO) Logolu Duyarlı Bölgeye Yaklaştırıp Okutun. 1 Uzun Bip Sesinden Sonra (Owner = Patron) Kartı Olarak Tanımlanacaktır.
- > İlk Olarak (Owner = Patron) Kartını Duyarlı Kısıma Okutun, Mavi Işık Yanıp Sönmeğe Başlar Sonra Diğer Kartı Duyarlı Bölgeye Okutun. Bip Sesinden Sonra (Master=Müdür) Kart olarak Tanımlayacaktır.
- > Kilitleme: '*' - Şifre - '#'
- > Açma: '*' - Aynı Şifre - '#'



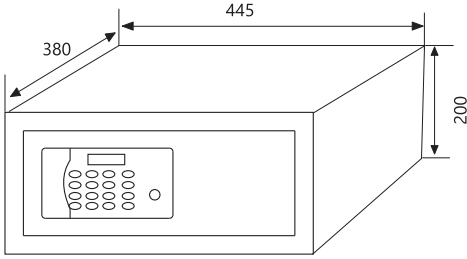

Ölçü	Kapak Kalınlığı
200 x 445 x 380	4/2 mm

Otel Tipi Laptop Kasası

Hotel Safety Deposit Box

Kod/Code	Açıklama/Description
070727	Otel Tipi Laptop Kasası Gri
070766	Otel Tipi Laptop Kasası Krem

TEKNİK DETAYLAR / Details

- > Rakamlı Kullanıcı Kodu Ve 8 Rakamlı Master Kod (Oteller İçin)
- > Manuel Olarak Kilitleme Opsiyonu
- > Motorlu Otomatik Açılım
- > Son 120 Açılımı Ekranda Görebilme
- > 3 Kez Hatalı Kod Girişi İle 3 Dakika Bloke Edilme Opsiyonu
- > Düşük Sarfiyatlı Pil Kullanımı, 4xaa 1,5 Volt Ve Azalan Pil Gücünü Hatırlatıcı Fonksiyon

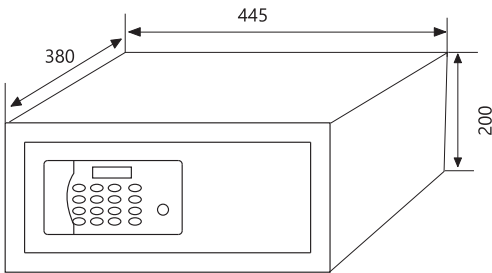

Ölçü	Kapak Kalınlığı
200 x 445 x 380	4/2 mm

Otel Tipi Laptop Kasası

Hotel Safety Deposit Box

Kod/Code	Açıklama/Description
070728	Otel Tipi Laptop Kasası Gri
070767	Otel Tipi Laptop Kasası Krem

TEKNİK DETAYLAR / Details

- > 4-6 Arası Dijital Kod İle Kilitleme Kombinasyonu / Manyetik Kart İle Açma Kapama Opsiyonu (Otel Kartlı Sistem Veya Banka Kartı)
- > Kodu Ekranda Gösterme Veya Gizleme Opsiyonu
- > Kendi Kendine Açılan Otomatik Kilit Sistemi
- > Son 105 İşlemi Ekranda Gösterme
- > 3 Kez Hatalı Kod Girişi İle Dakika Bloke Edilme Opsiyonu
- > Düşük Sarfiyatlı Pil Kullanımı, 4xAA 1,5 Volt Ve Azalan Pil Gücünü Hatırlatıcı Fonksiyon



Servis Tepsisi
Amenity Tray

Kod/Code	Açıklama/Description
219161	Hoşgeldin Ünitesi
TEKNİK DETAYLAR / Details	
Özellik	: Ahşap / ABS



Servis Tepsisi
Amenity Tray

Kod/Code	Açıklama/Description
219160	Hoşgeldin Ünitesi
TEKNİK DETAYLAR / Details	
Özellik	: ABS



Su Isıtıcı Siyah
Kettle Black

Kod/Code	Açıklama/Description
220179	Otel Tipi Su Isıtıcı Siyah 800 ml
TEKNİK DETAYLAR / Details	
Özellik	: ABS



Su Isıtıcı Krom
Kettle Chrome

Kod/Code	Açıklama/Description
088391	Otel Tipi Su Isıtıcı Chrome 800 ml
TEKNİK DETAYLAR / Details	
Özellik	: ABS



Servis Tepsisi

Amenity Tray

Kod/Code	Açıklama/Description
219159	Hoşgeldin Ünitesi
TEKNİK DETAYLAR / Details	
Özellik	: ABS



Bebek Ünitesi

Wall Mantel Baby Changing Unit

Kod/Code	Açıklama/Description
088415	Bebek Altı Değişirme Ünitesi
TEKNİK DETAYLAR / Details	
Özellik	: ABS



Bebek Ünitesi

Wall Mantel Baby Changing Unit

Kod/Code	Açıklama/Description
088936	Bebek Altı Değişirme Ünitesi
TEKNİK DETAYLAR / Details	
Özellik	: Paslanmaz Çelik, Saten



Servis Taşıma Arabası

Service Trolley

Kod/Code	Açıklama/Description
217143	Restaurant Servis Taşıma Arabası
TEKNİK DETAYLAR / Details	
Özellik	: Ahşap Tekerlekli



Valiz Taşıma Arabası Luggage Trolley

Kod/Code	Açıklama/Description
219163	Pirinç Valiz Taşıma Aracı
TEKNİK DETAYLAR / Details	
Özellik	: Pirinç



Bariyer Sistemi Crowd Control Belt Barrier With Over Base

Kod/Code	Açıklama/Description
073770	Bariyer Sistemi Şeritli
TEKNİK DETAYLAR / Details	
Özellik	: Paslanmaz, Krom



Mini Bar Buzdolabı Mini Bar Refrigerator

Kod/Code	Açıklama/Description
219157	Mini Bar Buzdolabı
TEKNİK DETAYLAR	
> Soğutma Kapasitesi	: 45 lt
> Genişlik	: 427 mm
> Yükseklik	: 565
> Enerji Tüketimi	: 0,23kwh/24H
> Voltaj	: 220-240/50 (V/Hz)
> Soğutucu Gaz	: R600a
> Net Ağırlık	: 19 Kg
> Çalışma Aralığı	: +2 - +8
> Soğutma	: Kompresör
> Kapasite	: 45 lt Tam Kapak



Mini Bar Buzdolabı Mini Bar Refrigerator

Kod/Code	Açıklama/Description
219158	Mini Bar Buzdolabı
TEKNİK DETAYLAR / Details	
> Soğutma Kapasitesi	: 40 lt
> Ölçüleri	: H545xW403xD436 mm
> Çalışma Aralığı	: +16/+32 C
> Soğutma Aralığı	: +5 / +7 C
> Soğutma Gazı	: R600A
> Enerji Tüketimi(Kwh/annum)	: 92
> Ses Düzeyi	: 0 db
> Net Ağırlık	: 16 kg
> Kırılmaz Cam Raf, Standart Sensörlü iç Aydınlatma, Otomatik Defrost, Standart Değiştirilebilir Kapı Yönü Beyaz ve Siyah Renk Seçeneği, Standart Kilit Sistemi	



Metal Bavulluk
Folding Luggage Rack

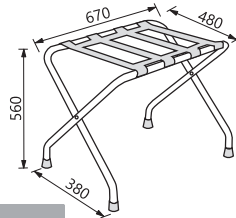

Kod/Code	Açıklama/Description
066561	Metal Bavulluk Altın
056796	Metal Bavulluk Krom

Paslanmaz Bavulluk
Stainless Steel Folding Luggage Rack

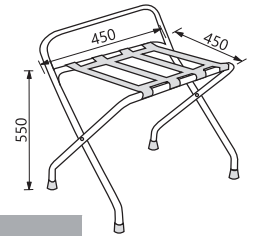

Kod/Code	Açıklama/Description
118890	Soho Bavulluk Paslanmaz

Ahşap Bavulluk
Folding Luggage Rack Wooden

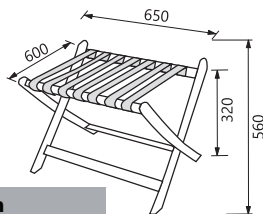

Kod/Code	Açıklama/Description
220178	Ahşap Bavulluk

Ahşap Bavulluk
Folding Luggage Rack

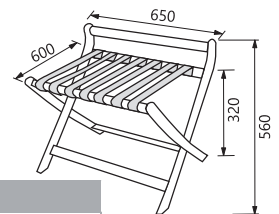

Kod/Code	Açıklama/Description
063435	Ahşap Bavulluk

amařır Sepeti Wenge
Laundry Basket



Kod/Code	Açıklama/Description
053034	amařır Sepeti Wenge 51x57hx29 cm

amařır Sepeti Wenge
Laundry Basket



Kod/Code	Açıklama/Description
194064	amařır Sepeti Wenge 49.2x60.2hx29 cm

amařır Sepeti
Laundry Basket



Kod/Code	Açıklama/Description
248352	amařır Sepeti Ø43x65h

amařır / Havlu Sepeti
Laundry Basket



Kod/Code	Açıklama/Description
248351	amařır Sepeti Ø27x39.5h

amařır Sepeti
Laundry Basket



Kod/Code	Açıklama/Description
248353	amařır Sepeti 58.5x82hx32 cm

amařır Sepeti Wenge
Laundry Basket



Kod/Code	Açıklama/Description
248354	amařır Sepeti 35x73hx35 cm

amařır Sepeti
Laundry Basket



Kod/Code	Açıklama/Description
004987	Raylı amařır Sepeti 34x47hx34 cm

amařır Sepeti
Laundry Basket



Kod/Code	Açıklama/Description
004490	amařır Sepeti Kapaęa Monte 23x39hx23 cm



Pedallı Çöp Kovası
Pedal Bin

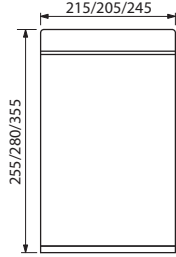

Kod/Code	Açıklama/Description
088420	3 lt Pedallı Çöp Kovası Ø215/255mm
055556	5 lt Pedallı Çöp Kovası Ø205/280mm
008112	12 lt Pedallı Çöp Kovası Ø245/355mm

Pedallı Çöp Kovası
Pedal Bin

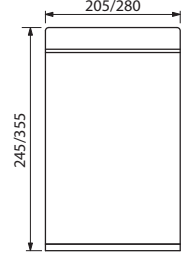

Kod/Code	Açıklama/Description
146657	5 lt Pedallı Çöp Kovası Ø205/280mm
219165	12 lt Pedallı Çöp Kovası Ø245/355mm

Çöp Kovası
Waste Bin

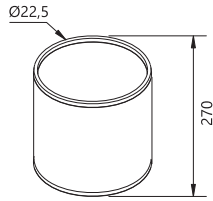

Kod/Code	Açıklama/Description
073757	Soho Kağıt Sepeti 12 lt Krom Paslanmaz
073758	Soho Kağıt Sepeti 12 lt Mat Paslanmaz

Çöp Kovası
Waste Bin

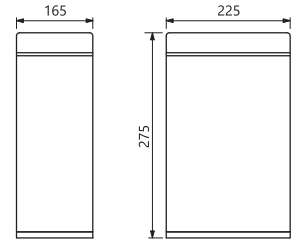

Kod/Code	Açıklama/Description
061099	Soho Köşeli Çöp Kovası 6 lt Mat Paslanmaz

Çöp Kovası
Waste Bin

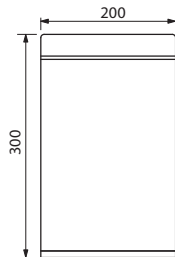

Kod/Code	Açıklama/Description
118884	Soho Çöp Kovası 20x30cm Paslanmaz



Çöp Kovası
Pedal Bin

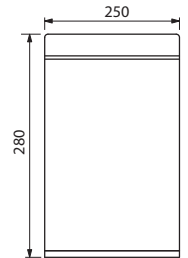

Kod/Code	Açıklama/Description
118882	Çöp Kovası Kapaklı 5 lt Krom
118883	Çöp Kovası Kapaklı 12 lt Krom

Çöp Kovası
Waste Bin

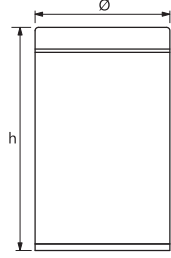

Kod/Code	Açıklama/Description	h x Ø
063961	Bilyeli Çöp Kovası Kapaksız 3 Lt Krom	230 x 195
073748	Bilyeli Çöp Kovası Kapaksız 5 Lt Krom	265 x 215
073749	Bilyeli Çöp Kovası Kapaksız 12 Lt Krom	355 x 260

Pedallı Çöp Kovası
Waste Bin

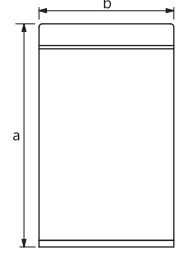

Kod/Code	Açıklama/Description	a x b
073750	Çöp Kovası Kapaksız 3 Lt Krom	224 x 178
064145	Çöp Kovası Kapaksız 5 Lt Krom	260 x 215
073751	Çöp Kovası Kapaksız 12 Lt Krom	330 x 250

Bilyeli Çöp Kovası
Waste Bin

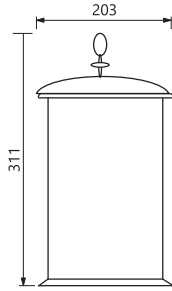

Kod/Code	Açıklama/Description
061095	Bilyeli Çöp Kovası Kapaklı 3 Lt Krom
061096	Bilyeli Çöp Kovası Kapaklı 5 Lt Antik
061097	Bilyeli Çöp Kovası Kapaklı 12 Lt Altın

Ofis Tipi Çöp Kovası
Waste Bin

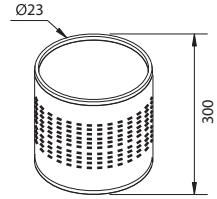

Kod/Code	Açıklama/Description
220167	Soho Ofis Tipi Delikli Çöp Kovası 23x30 cm
220168	Soho Ofis Tipi Düz Çöp Kovası 23x30 cm

Deri Çöp Kovası
Waste Bin

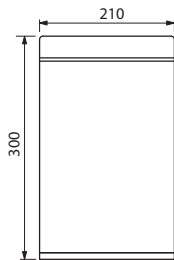

Kod/Code	Açıklama/Description
220170	Soho Ofis Tipi Derili Çöp Kovası 3 Lt
220171	Soho Ofis Tipi Derili Çöp Kovası 5 Lt

Deri Çöp Kovası
Waste Bin

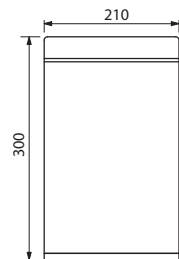

Kod/Code	Açıklama/Description
118884	Soho Ofis Tipi Derili 10 Lt Ø21x30 cm

Deri Çöp Kovası
Waste Bin

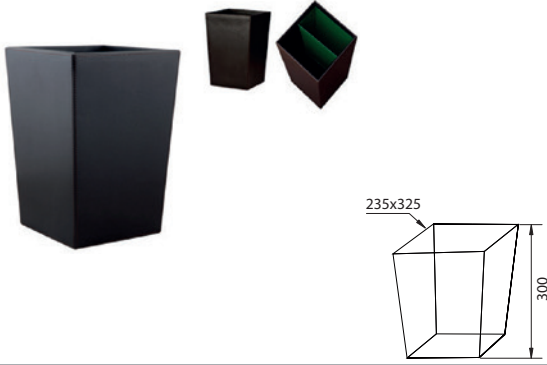

Kod/Code	Açıklama/Description
220173	Soho Bölmesiz Çöp Kovası 23.5x32.5x30 cm
220174	Soho Bölmeli Çöp Kovası 23.5x32.5x30 cm

Ofis Tipi Çöp Kovası
Waste Bin



Kod/Code	Açıklama/Description
008125	Soho Orta Boy Kağıt Sepeti Gri
061229	Soho Orta Boy Kağıt Sepeti Siyah

Sallanır Kapaklı Çöp Kovası
Waste Bin

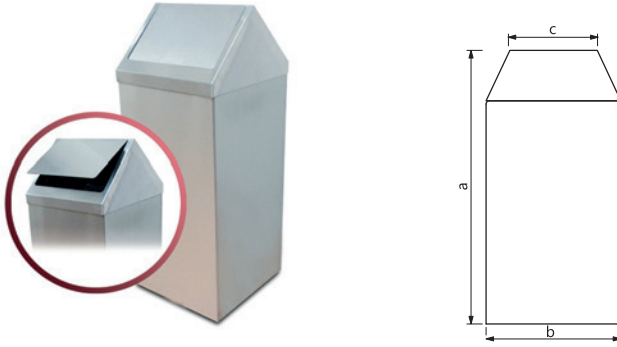

Kod/Code	Açıklama/Description
008081	Sallanır Kapaklı Çöp Kovası 6 lt 220x170x150 mm
008087	Sallanır Kapaklı Çöp Kovası 11 lt 300x200x180 mm
064249	Sallanır Kapaklı Çöp Kovası 25 lt 400x280x240 mm
010314	Sallanır Kapaklı Çöp Kovası 36 lt 580x300x300 mm

Kapaklı Çöp Kovası
Waste Bin



Kod/Code	Açıklama/Description
219166	Pratik Sallanır Kapaklı Çöp Kovası 8 lt
219167	Pratik Sallanır Kapaklı Çöp Kovası 20 lt

Ofis Tipi Çöp Kovası
Waste Bin

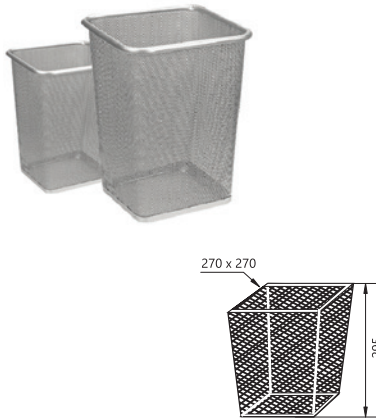

Kod/Code	Açıklama/Description
061232	Soho Ofis Tipi Kağıt Sepeti Gri

Prinç Şemsiyelik
Brass Umbrella Stand

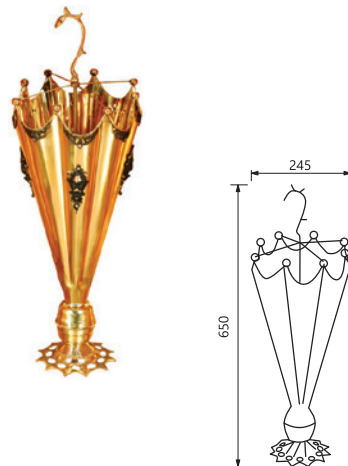

Kod/Code	Açıklama/Description
064049	Pirinç Şemsiyelik

Paslanmaz Şemsiyelik
Stainless Steel Umbrella Stand

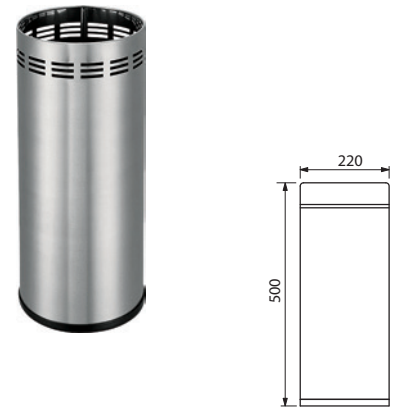

Kod/Code	Açıklama/Description
118888	Soho Paslanmaz Şemsiyelik Ø22x50 cm



Kolon Küllüklü Çöp Kovası
Waste Bin With Ashtray

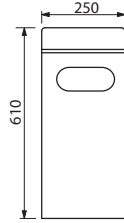

Kod/Code	Açıklama/Description
118886	Soho Kolon 25x61 cm Küllüklü Çöp Kovası Ps.

Kolon Küllüklü Çöp Kovası
Waste Bin With Ashtray

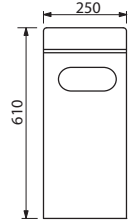

Kod/Code	Açıklama/Description
118885	Soho Kolon 25x61 cm Küllüklü Çöp Kovası

Kare Küllüklü Çöp Kovası
Waste Bin With Ashtray

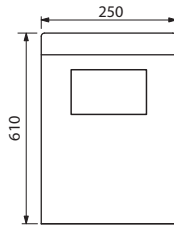

Kod/Code	Açıklama/Description
118887	Soho Kare Küllüklü Çöp Kovası 25x61 cm Mat Pas.

Özel Küllüklü Çöp Kovası
Waste Bin With Ashtray

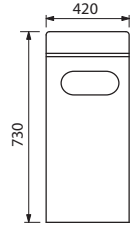

Kod/Code	Açıklama/Description
219168	Özel Küllüklü Çöp Kovası Paslanmaz

Camlı Kare Çöp Kovası
Waste Bin With Ashtray

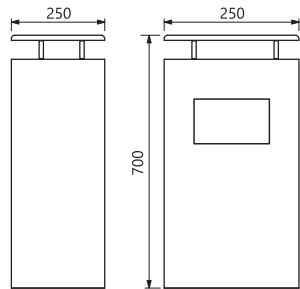

Kod/Code	Açıklama/Description
073836	Soho Kare Camlı Küllüklü 25x25x70 Çöp kovası

Kolon Küllüklü Çöp Kovası
Waste Bin With Ashtray

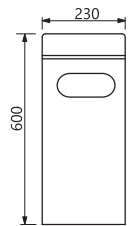

Kod/Code	Açıklama/Description
008105	Soho Kolon Küllüklü Çöp Kovası 23x60 cm Pas.

Delikli Kolon Çöp Kovası
Waste Bin With Ashtray

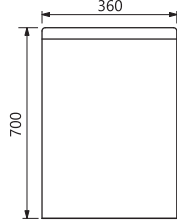

Kod/Code	Açıklama/Description
057668	Soho Çöp Kovası Delikli 36x70 cm Paslanmaz

Delikli Çöp Kovası
Waste Bin With Ashtray

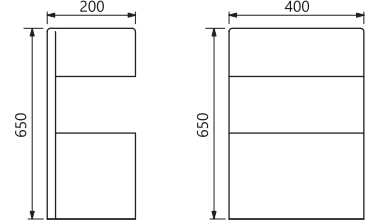

Kod/Code	Açıklama/Description
054422	Soho Çöp Kovası Delikli 20x40x65 cm Paslanmaz

Bahçe Tipi Çöp Kovası
Outdoor Waste Bin

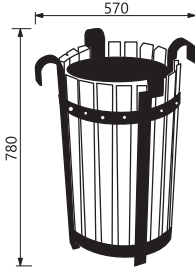

Kod/Code	Açıklama/Description
073760	Dış Mekan Bahçe Tipi Çöp Kovası Ø57x78 cm

Bahçe Tipi Çöp Kovası
Outdoor Waste Bin

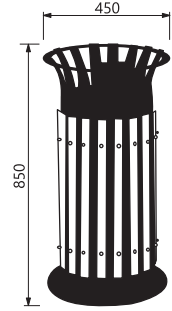

Kod/Code	Açıklama/Description
073761	Dış Mekan Bahçe Tipi Çöp Kovası Ø45x85 cm

Kolon Küllüklü Çöp Kovası
Waste Bin With Ashtray

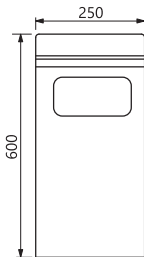

Kod/Code	Açıklama/Description
073764	Bahçe Tipi Boyalı Çöp Kovası Ø25x60 cm

Kolon Küllüklü Çöp Kovası
Waste Bin With Ashtray

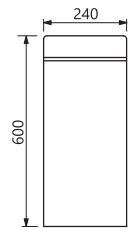

Kod/Code	Açıklama/Description
008095	Bahçe Tipi Boyalı Çöp Kovası Ø23x60 cm

Vip Küllük
Outdoor Ashtray

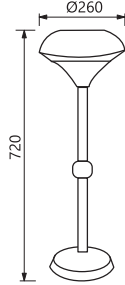

Kod/Code	Açıklama/Description
118886	Dış Mekan Küllük Prinç Ø26x72 cm

Vip Küllük
Outdoor Ashtray



Kod/Code	Açıklama/Description
220175	Dış Mekan Küllük Altın

Bahçe Tipi Çöp Kovası
Outdoor Waste Bin

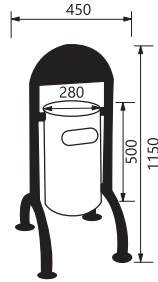

Kod/Code	Açıklama/Description
073762	Dış Mekan Çöp Kovası Sallanır 4 Ayaklı 45x150 cm Kova: Ø28x50 cm

Bahçe Tipi Çöp Kovası
Recycling - Waste Sorting Unit - Outdoor

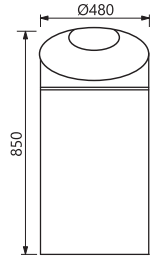

Kod/Code	Açıklama/Description
073835	Üç Hazneli Çöp Ayırım Ünitesi Boyalı

Paslanmaz Çelik Sakı
Pot

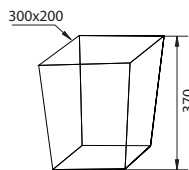

Kod/Code	Açıklama/Description
220176	Paslanmaz Çelik Sakı 30x20x37 cm

Paslanmaz Çelik Sakı
Pot

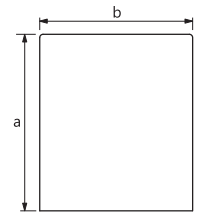

Kod/Code	Açıklama/Description
052838	Paslanmaz Sakı Ø40 50 lt
063707	Paslanmaz Sakı Ø45 72 lt
073768	Paslanmaz Sakı Ø50 100 lt

Parlak Alüminyum Portmanto 351 F
Aluminium Coat Stand



Parlak Alüminyum

Kod/Code	Açıklama/Description
070677	Parlak Alüminyum Portmanto

TEKNİK DETAYLAR / Details

Malzeme	: Metal + Alüminyum
Renk	: Parlak Alüminyum
Yükseklik	: 1800 mm

Ahşap Görünümlü Portmanto 351 F
Wooden Coat Stand (Wooden Skin)



Ahşap Görünümlü

Kod/Code	Açıklama/Description
070676	Ahşap Görünümlü Portmanto

TEKNİK DETAYLAR / Details

Malzeme	: Metal + Boyalı
Renk	: Ahşap Görünümlü
Yükseklik	: 1800 mm

Metal Portmanto
Metal Coat Stand



Kod/Code	Açıklama/Description
058927	Metal Portmanto Siyah 104

TEKNİK DETAYLAR / Details

Malzeme	: Metal + Plastik
Ölçü	: 51 x 1 mm
Renk	: Krom, Siyah
Yükseklik	: 1700 mm

Metal Portmanto
Metal Coat Stand



Kod/Code	Açıklama/Description
007987	Metal Portmanto Krom

TEKNİK DETAYLAR / Details

Malzeme	: Metal + Boyalı
Ölçü	: 51 x 1 mm
Renk	: Krom, Siyah
Yükseklik	: 1650 mm



Özel Ölçü ve Üretim Kollu Menfez
Aluminium Ventilation Grill

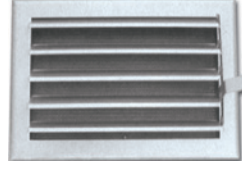

Kod/Code	Açıklama/Description
032420	Özel Ölçü Kollu Menfez
TEKNİK DETAYLAR / Details	
Malzeme	: Alüminyum
Üst Yüzey	: Eloksal
> İsteğe Bağlı Özel Ölçülerde Üretim Yapılmaktadır.	

Özel Ölçü ve Üretim Kolsuz Menfez
Aluminium Ventilation Grill



Kod/Code	Açıklama/Description
058256	Özel Ölçü Kolsuz Menfez
TEKNİK DETAYLAR / Details	
Malzeme	: Alüminyum
Üst Yüzey	: Eloksal
> İsteğe Bağlı Özel Ölçülerde Üretim Yapılmaktadır.	

Alüminyum Menfez 120 x150 mm
Aluminium Ventilation Grill

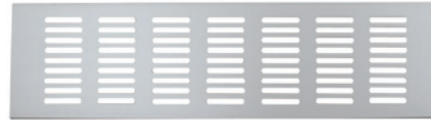

Kod/Code	Açıklama/Description
010529	Alüminyum Menfez 120 x 500 mm
TEKNİK DETAYLAR / Details	
Malzeme	: Alüminyum
Üst Yüzey	: Eloksal
> İsteğe Bağlı Özel Ölçülerde Üretim Yapılmaktadır.	

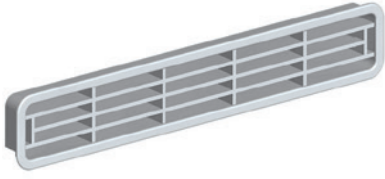

Havalandırma Menfezi 0600
Ventilation Grill

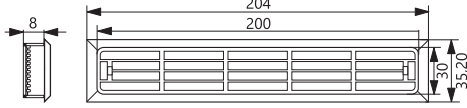

Kod/Code	Açıklama/Description
073780	Havalandırma Menfezi gri
073781	Havalandırma Menfezi Kahve
064200	Havalandırma Menfezi Krom
073782	Havalandırma Menfezi Siyah

TEKNİK DETAYLAR / Details

Malzeme : Plastik



Havalandırma Menfezi 0680
Ventilation Grill

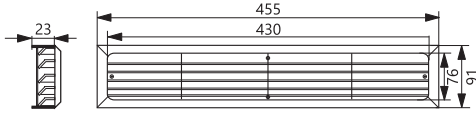

Kod/Code	Açıklama/Description
073778	Havalandırma Menfezi Metalik Gri
073779	Havalandırma Menfezi Kahve

TEKNİK DETAYLAR / Details

Malzeme : Plastik

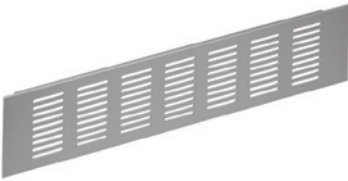

Havalandırma Menfezi
Aluminium Ventilation Grill

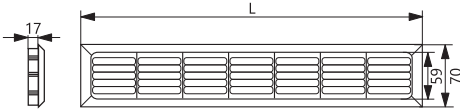

hxL	Renk		
	Eloksal	Krom	İnoks
70 x 300	010536	058698	058699
70 x 400	010532	058702	058703
70 x 500	010526	058706	058707
70 x 600	073777	058710	058711

TEKNİK DETAYLAR / Details

Malzeme : Alüminyum

> İsteğe Bağlı Özel Ölçülerde Üretim Yapılmaktadır.

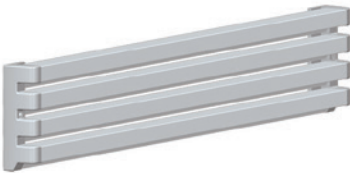

Havalandırma Menfezi 0460
Aluminium Ventilation Grill

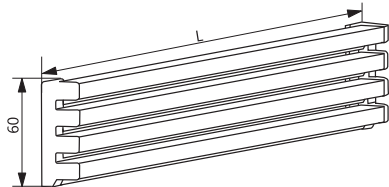

Uzunluk (L)	Renk	
	Eloksal	İnoks
423 mm	073772	071435
610 mm	073773	073775
900 mm	073774	073776

TEKNİK DETAYLAR / Details

Malzeme : Alüminyum

Üst Yüzey : Eloksal

> İsteğe Bağlı Özel Ölçülerde Üretim Yapılmaktadır.

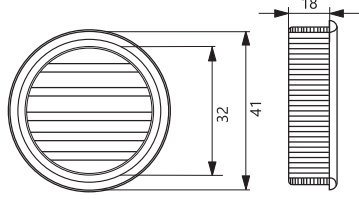

Menfez 4114-03

Plastic Ventilation

Kod/Code	Açıklama/Description
----------	----------------------

011292	Menfez Mat Krom
--------	-----------------

TEKNİK DETAYLAR / Details

Malzeme: : Mat Krom + Plastik

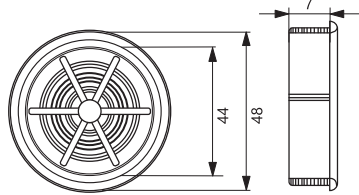

Havalandırma Menfezi 0660

Plastic Ventilation

Kod/Code	Açıklama/Description
----------	----------------------

073783	Havalandırma Menfezi Zıpkın Dişli Kahve
--------	---

073785	Havalandırma Menfezi Zıpkın Dişli Gri
--------	---------------------------------------

073784	Havalandırma Menfezi Zıpkın Dişli Krom
--------	--

TEKNİK DETAYLAR / Details

Malzeme: : Plastik

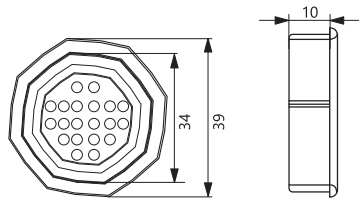

Havalandırma Menfezi 0620

Plastic Ventilation

Kod/Code	Açıklama/Description
----------	----------------------

073786	Havalandırma Menfezi Kahve
--------	----------------------------

073787	Havalandırma Menfezi Gri
--------	--------------------------

073788	Havalandırma Menfezi Krom
--------	---------------------------

TEKNİK DETAYLAR / Details

Malzeme: : Plastik

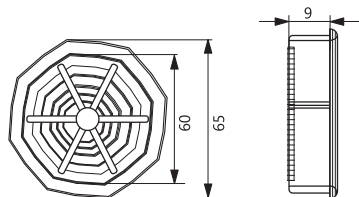

Havalandırma Menfezi 0610

Plastic Ventilation

Kod/Code	Açıklama/Description
----------	----------------------

073790	Havalandırma Menfezi Kahve
--------	----------------------------

073791	Havalandırma Menfezi Gri
--------	--------------------------

073789	Havalandırma Menfezi Krom
--------	---------------------------

TEKNİK DETAYLAR / Details

Malzeme: : Plastik

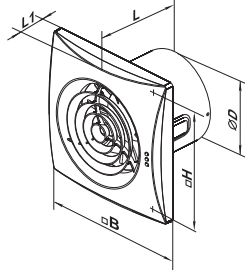

Duvar ve Tavan Tipi Fan Quiet Seri Ventilation Fan (Wall Ceiling)

**Kanala Bağlanabilir
Panjurlu**

Kod/Code	Model	Ses Seviyesi	Hava Debisi
070597	Quiet 100 Pilot Lamba, Panjur	25 (dBA)	100 (m ³ /h)
073792	Quiet 100T Pilot Lamba, Panjur,timer	25 (dBA)	100 (m ³ /h)

TEKNİK DETAYLAR / Details

- > Satte 7,5 Watt ile Minimum Enerji Tüketir
- > Uzun Ömürlü Motor
- > IP 45 Koruma Sınıfı
- > Çekme Kordon Seçenekli

ØD	B	H	L	L1
99	158	136	107	26

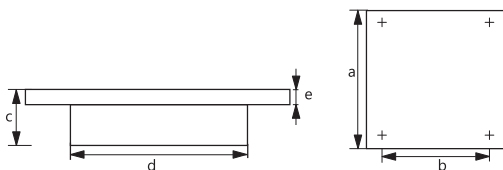

Cam Tipi Fan LDQ Seri Ventilation Fan (Glass)

**Aşırı Isınma
Korumalı, Sessiz Fan**

Kod/Code	Type	a	b	c	d	e	Çap	Ses dBA	Debi
063539	100 LDQ	150	120	126	100	30	100	25	70
073793	125 LDQ	176	140	134	125	30	125	34	170
063541	150 LDQ	205	165	153	150	30	150	32	215

TEKNİK DETAYLAR / Details

- > Minimum Enerji ile Çalışma 8 - 12 Watt
- > Beyaz ve Krom Renk Alternatifi, Modern ve Estetik Görünüm
- > Pilot Lamba, Yüksek Kalitede Dayanaklı, ABS Plastik Gövde



Play Classic



Play Satin

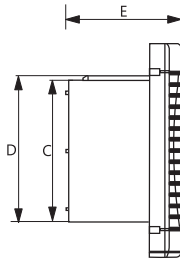
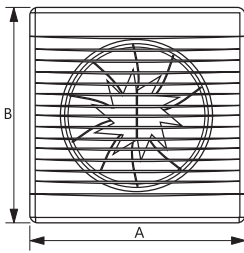

Model	A	B	C	D	E
Play Ø100	147	147	98	100	78
Play Ø125	171	171	124	126	88

Duvar ve Tavan Tipi Fan Play Seri Ventilation Fan

Sessiz Fan

Kod/Code	Model	Ses Seviyesi	Hava Debisi
070713	Play Classic 100 S	26 (dBA)	100 (m ³ /h)
073794	Play Saten 100 S	26 (dBA)	100 (m ³ /h)
073795	Play Classic 100 WC Timerli	26 (dBA)	100 (m ³ /h)
073796	Play saten 100 WC Timerli	26 (dBA)	100 (m ³ /h)
073797	Play Classic 125 S	31 (dBA)	150 (m ³ /h)
073798	Play Saten 125 S	31 (dBA)	150 (m ³ /h)
073800	Play Classic 125 WC Timerli	31 (dBA)	150 (m ³ /h)
073799	Play Saten 125 WC Timerli	31 (dBA)	150 (m ³ /h)

TEKNİK DETAYLAR / Details

- > Classic Serisi Beyaz, Satin Serisi Krom Renklidir
- > Düşük Enerjilidir, 100 Modelleri Satte 8 Watt, 125 Modelleri 10 Watt Enerji Kullanılır
- > Max. Çalışma Isısı 40°C
- > WP Çekme Kablosu Anahtarı, WCH Zamanlayıcı
- > Periyodik Temizleme Kolay Sökülebilen Pervane
- > Kanala Bağlanabilir
- > Koruma Sınıfı IP 24

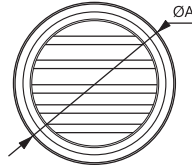

Model	ØA	B	C
Euro Ø100	98	98	98
Euro Ø120	118	83	102

Euro Seri Fan Ventilation Fan

Yuvarlak Kanal Fanı

Kod/Code	Model	Ses Seviyesi	Hava Debisi
073801	Euro 100	40 (dBA)	100 (m ³ /h)
073802	Euro 120	46 (dBA)	150 (m ³ /h)

TEKNİK DETAYLAR / Details

- > Maksimum Çalışma Sıcaklığı 40°C
- > Güç Euro 100 Modelinde 15W, Euro 120 Modelinde 17W
- > Basınç 100 Euro Modelinde 34 Pa, Euro 120 Modelinde 49 Pa
- > Akım Tüketimi Euro 100 Modelinde A 0, 12, Euro 120 Modelinde 0,13
- > IP X 2 Koruma Sınıfı

Duvar ve Tavan Tipi Fan D Seri Ventilation Fan

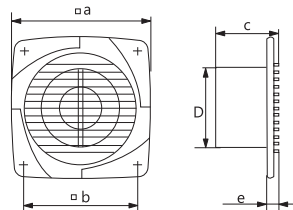

Kod/Code	Type	a	b	c	D	e	Ses dBA	Debi
073803	100 D	150	120	108	100	12	34	100
073804	125 D	176	140	114	125	13	35	180
073805	150 D	205	165	132	150	15	38	300

TEKNİK DETAYLAR / Details

- > İnce Dizayn, Modern Tasarım, Estetik Görünüm
- > Banyo Sürekli veya Periyodik Havalandırma, Duş, Mutfak ve Diğer Mekanların Havalandırılması
- > Güvenilir ve Düşük Watt Elektrik Motoru
- > Pervane ve Gövde Yüksek Kalitede, Dayanıklı ABS Plastikten İmal Edilmiştir. UV Dayanımlıdır.
- > Kanala Bağlanabilir Dahili Sinek Telli IP 34 Koruma Sınıfı

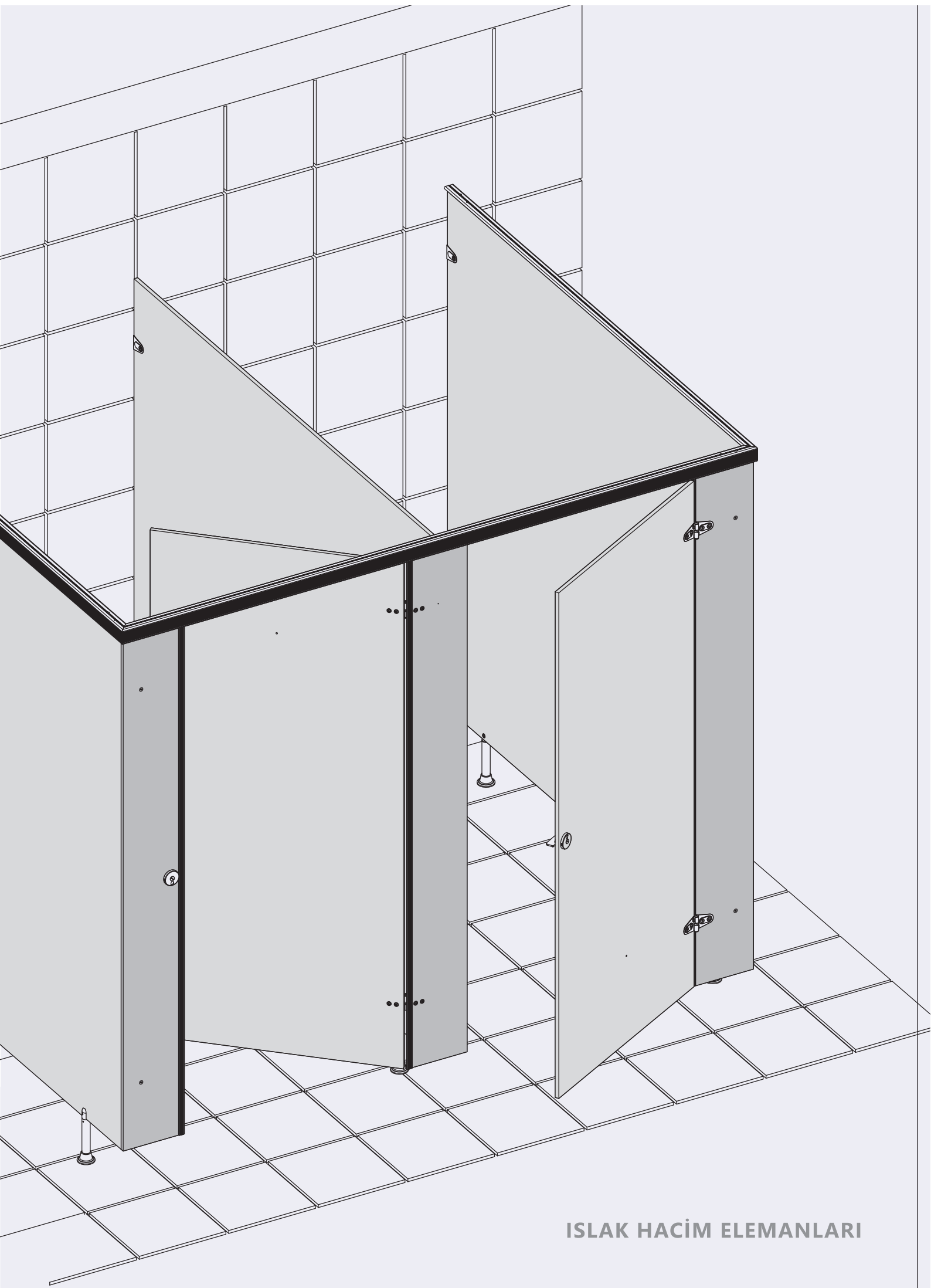

ISLAK HACİM ELEMANLARI

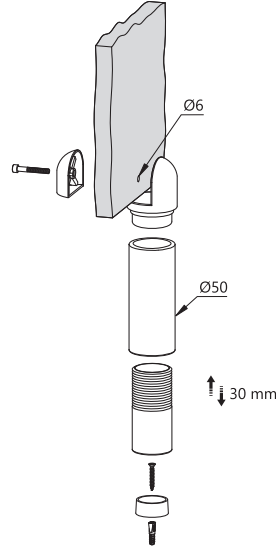

Kabin Ayak Elemanı Cabin Panel Bracket

Kod/Code	Açıklama/Description
007108	Kabin Ayak Elemanı Beyaz
007110	Kabin Ayak Elemanı Siyah

TEKNİK DETAYLAR / Details

Malzeme	: Basınçlı Zamak Metal + Alüminyum
Ölçü	: 230 mm
Renk	: Siyah, Beyaz, Metalik

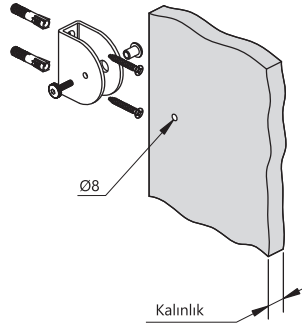

Kabin U Bağlantı Elemanı Cabin Panel Bracket

Kod/Code	Açıklama/Description
007112	Kabin U Bağlantı Elemanı 18 mm Beyaz
007114	Kabin U Bağlantı Elemanı 18 mm Siyah
007116	Kabin U Bağlantı Elemanı 13 mm Beyaz
007117	Kabin U Bağlantı Elemanı 13 mm Siyah
007115	Kabin U Bağlantı Elemanı 18 mm Metalik
007119	Kabin U Bağlantı Elemanı 13 mm Metalik

TEKNİK DETAYLAR / Details

Malzeme	: Alüminyum
Ölçü	: 25 x 64 mm
Ölçü	: 30 x 64 mm
Renk	: Siyah, Beyaz, Metalik, Krom

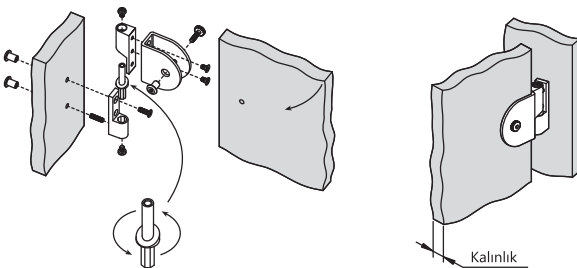

Kabin Menteşesi Cabin Panel Hinge

Sağ ve Sola
Açılma Özelliği

Kod/Code	Açıklama/Description
007137	Kabin Menteşesi 13 mm Beyaz
007127	Kabin Menteşesi 13 mm Siyah
007123	Kabin Menteşesi 18 mm Beyaz
007124	Kabin Menteşesi 18 mm Siyah
007125	Kabin Menteşesi 18 mm Metalik
007130	Kabin Menteşesi 13 mm Metalik

TEKNİK DETAYLAR / Details

Malzeme	: Basınçlı Zamak Metal + Alüminyum
Ölçü	: 25 x 92 mm
Ölçü	: 30 x 92 mm
Renk	: Siyah, Beyaz, Metalik, Krom



Kabin Kapı Kilidi Cabin Door Lock

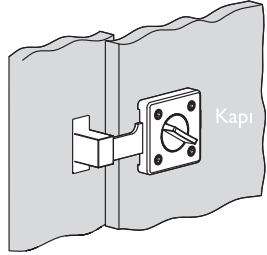

İçe açılır

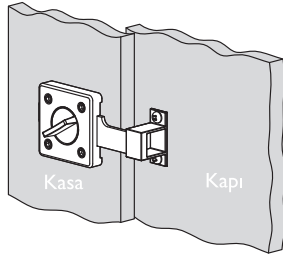

Dışa açılır

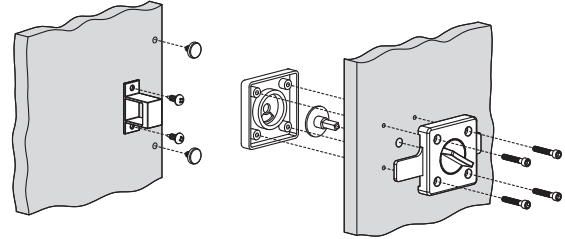

Kod/Code	Açıklama/Description
007138	Kabin Kapı Kilidi Beyaz
007140	Kabin Kapı Kilidi Siyah
007141	Kabin Kapı Kilidi Metalik

TEKNİK DETAYLAR / Details

Malzeme	: Basıncılı Zamak Metal + Plastik
Ölçü	: 70 x 120 mm
Renk	: Siyah, Beyaz, Metalik, Krom

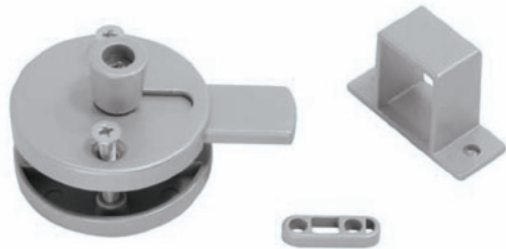

Kabin Kapı Kilidi Cabin Door Lock

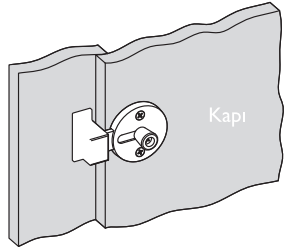

İçe açılır

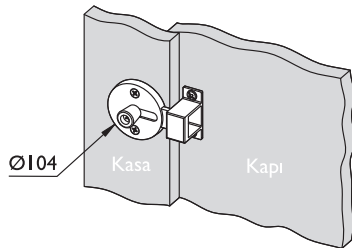

Dışa açılır

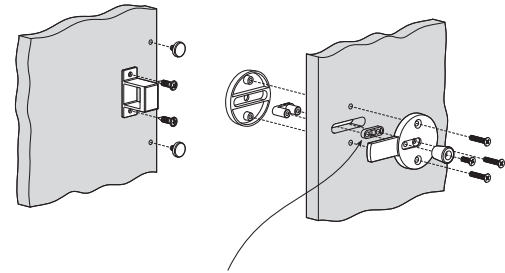

18mm paneller için ilave parça

Kod/Code	Açıklama/Description
007149	Kabin Kapı Kilidi Beyaz
053202	Kabin Kapı Kilidi Siyah
007150	Kabin Kapı Kilidi Metalik

TEKNİK DETAYLAR / Details

Malzeme	: Basıncılı Zamak Metal + Plastik
Ölçü	: 104 x 60 mm
Renk	: Siyah, Beyaz, Metalik, Krom



Kabin L Bağlantı Elemanı Cabin Panel Connection Fitting

Kod/Code	Açıklama/Description
007121	Kabin L Bağlantı Elemanı Siyah
007120	Kabin L Bağlantı Elemanı Beyaz
007122	Kabin L Bağlantı Elemanı Metalik

TEKNİK DETAYLAR / Details

Malzeme	: Alüminyum
Ölçü	: 61 x 64 mm
Renk	: Siyah, Beyaz, Metalik, Krom

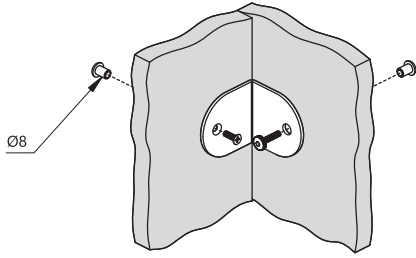

Kabin Kapı Tokmağı Cabin Door Knob

Kod/Code	Açıklama/Description
007143	Kabin Kapı Tokmağı Beyaz
007144	Kabin Kapı Tokmağı Siyah
007146	Kabin Kapı Tokmağı Metalik

TEKNİK DETAYLAR / Details

Malzeme	: Basınçlı Zamak Metal
Ölçü	: 50 x 52 mm
Renk	: Siyah, Beyaz, Metalik, Krom

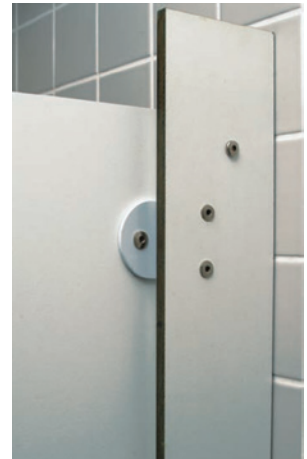
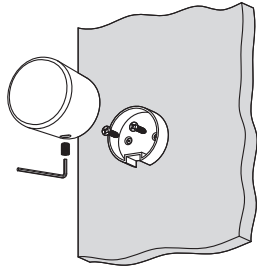

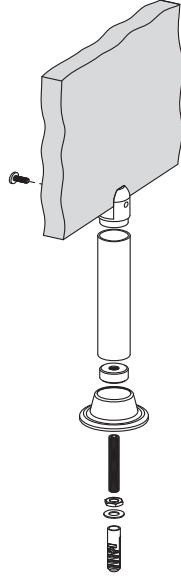

Kabin Ayak Cabin Panel Leg

Kod/Code	Açıklama/Description
071999	Kabin Ayak Ø25 Paslanmaz

TEKNİK DETAYLAR / Details	
Malzeme	: 304 Paslanmaz Çelik
Ölçü	: 150 mm
Renk	: Saten

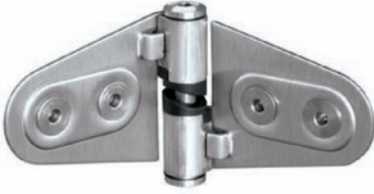

Kabin Kapı Mentешesi Cabin Door Hinge

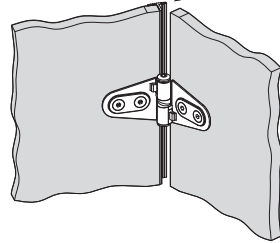
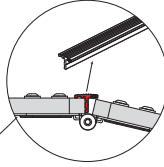

Kod/Code	Açıklama/Description
072207	Kabin Kapı Mentешesi Paslanmaz Sağ
072203	Kabin Kapı Mentешesi Paslanmaz Sol
072206	Kabin Bini Çıtası Alüminyum 19x15 mm

TEKNİK DETAYLAR / Details	
Malzeme	: Alüminyum + 304 Paslanmaz Çelik
Ölçü	: 124 x 57 mm
Renk	: Saten



Kilitli Pozisyon



Açık Pozisyon

Kabin Kapı Kilidi Cabin Door Lock

Kod/Code	Açıklama/Description
071998	Kabin Kapı Kilidi Paslanmaz

TEKNİK DETAYLAR / Details	
Malzeme	: 304 Paslanmaz Çelik
Ölçü	: 60 x 36 mm
Renk	: Saten

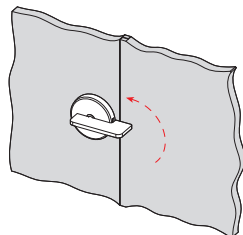
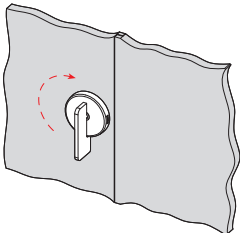

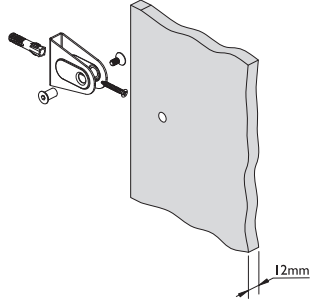

Kabin U Bağlantı

Cabin Panel Connection Fitting

Kod/Code	Açıklama/Description
072001	Kabin U Bağlantı Paslanmaz

TEKNİK DETAYLAR / Details

Malzeme	: 304 Paslanmaz Çelik
Ölçü	: 58 x 48 x 18 mm
Renk	: Saten

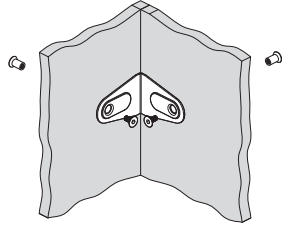

Kabin L Bağlantı

Cabin Panel Connection Fitting

Kod/Code	Açıklama/Description
072002	Kabin L Bağlantı Paslanmaz

TEKNİK DETAYLAR / Details

Malzeme	: 304 Paslanmaz Çelik
Ölçü	: 65 x 48 mm
Renk	: Saten

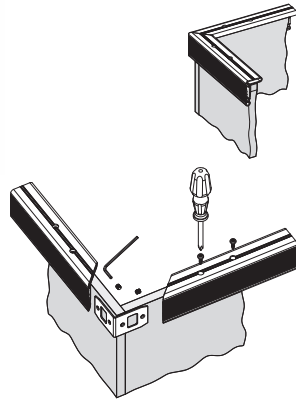
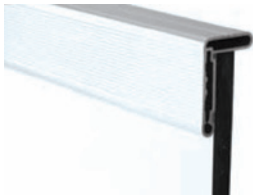

Kabin Taç Profili

Cabin Panel Top Profile

Kod/Code	Açıklama/Description
072005	Kabin Taç Profili Paslanmaz

TEKNİK DETAYLAR / Details

Malzeme	: Alüminyum
Ölçü	: 3660
Renk	: Mat Alüminyum

