

Kayar Katlanır Kapaklar Slide Systems

"İyi Fikirler, İyi Çözümler..."

05





TEKNİK DETAYLAR / SET İÇİNDEKİLER

- > 2 Kanallı üstte çalışan kapak sistemi
- > Önde duran kapak pozisyonu
- > Ahşap kapaklar için
- > Kapak Ağırlığı maks. 50kg
- > Kapak yüksekliği maks. 2500mm
- > Kapak Genişliği maks. 500mm
- > Kapak Kalınlığı : 16,18,19,21,25,28mm
- > Kapama-açma-ve çarpma yönünde opsiyonel silent System fren
- > DIN EN15706, 3. seviye uyarınca test edilmiştir.
- > **Paket İçeriğine 3m Ray Dahil Edilmiştir**

Top Line 22 - Ahşap Kapaklar

Sistem Parçaları (50 Kg)
Sliding Door System

Paket Kod	Açıklama/Description
HT056748	2 Ahşap Kapak İçin 21 mm Frenli Sistem
HT056753	3 Ahşap Kapak İçin 21 mm Frenli Sistem
HT056754	2 Ahşap Kapak İçin 28 mm Frenli Sistem
HT056755	3 Ahşap Kapak İçin 28 mm Frenli Sistem

Kapak ölçüleri ve Kapak Pozisyonu

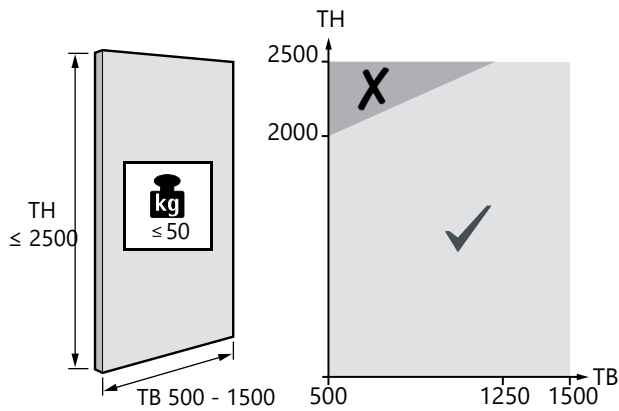

TB	500	600	700	800	900	1000	1100	1250	...	1500
TH ≤	2000	2066	2133	2200	2266	2333	2400	2500	...	2500

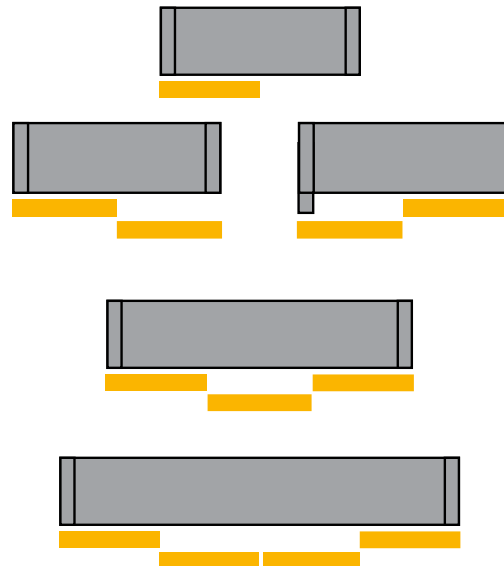

Montaj ölçüleri 2- kapak, STB 11 Yataklı Makara Klavuz Sistemi

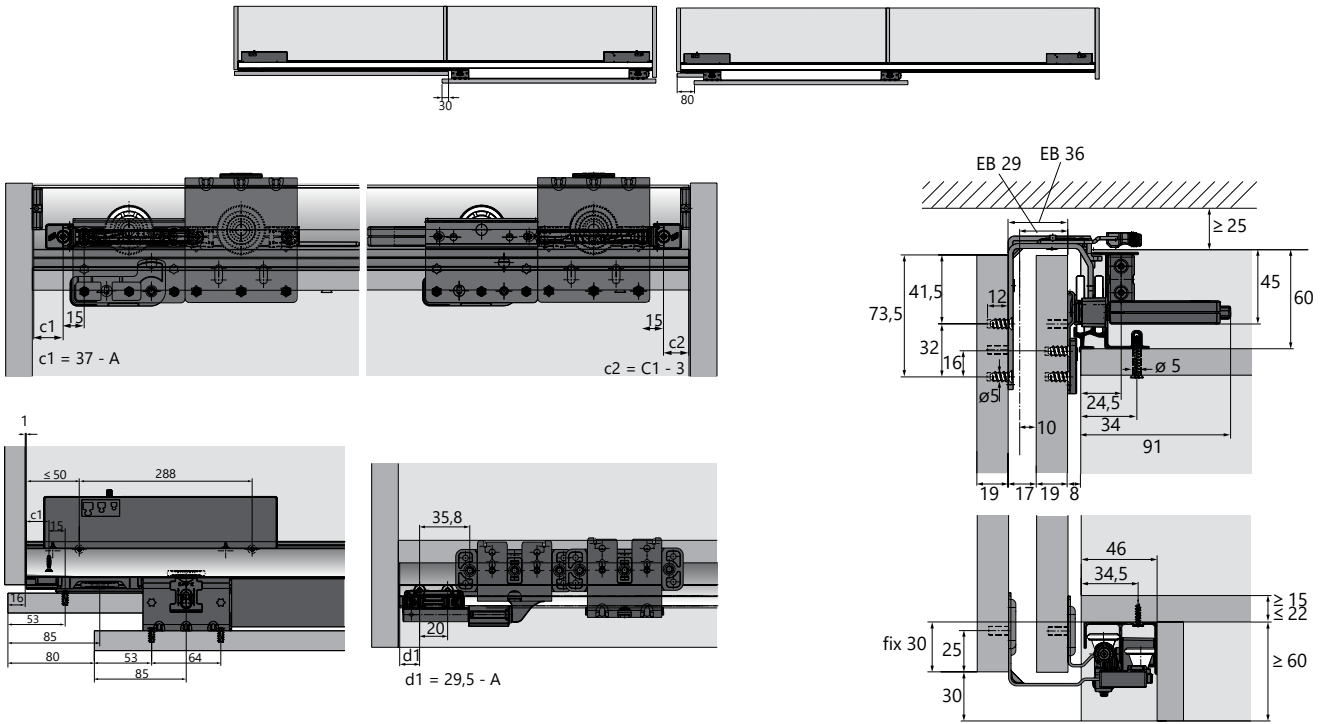

Montaj ölçüleri 3- kapak, STB 11 Yataklı Makara Klavuz Sistemi

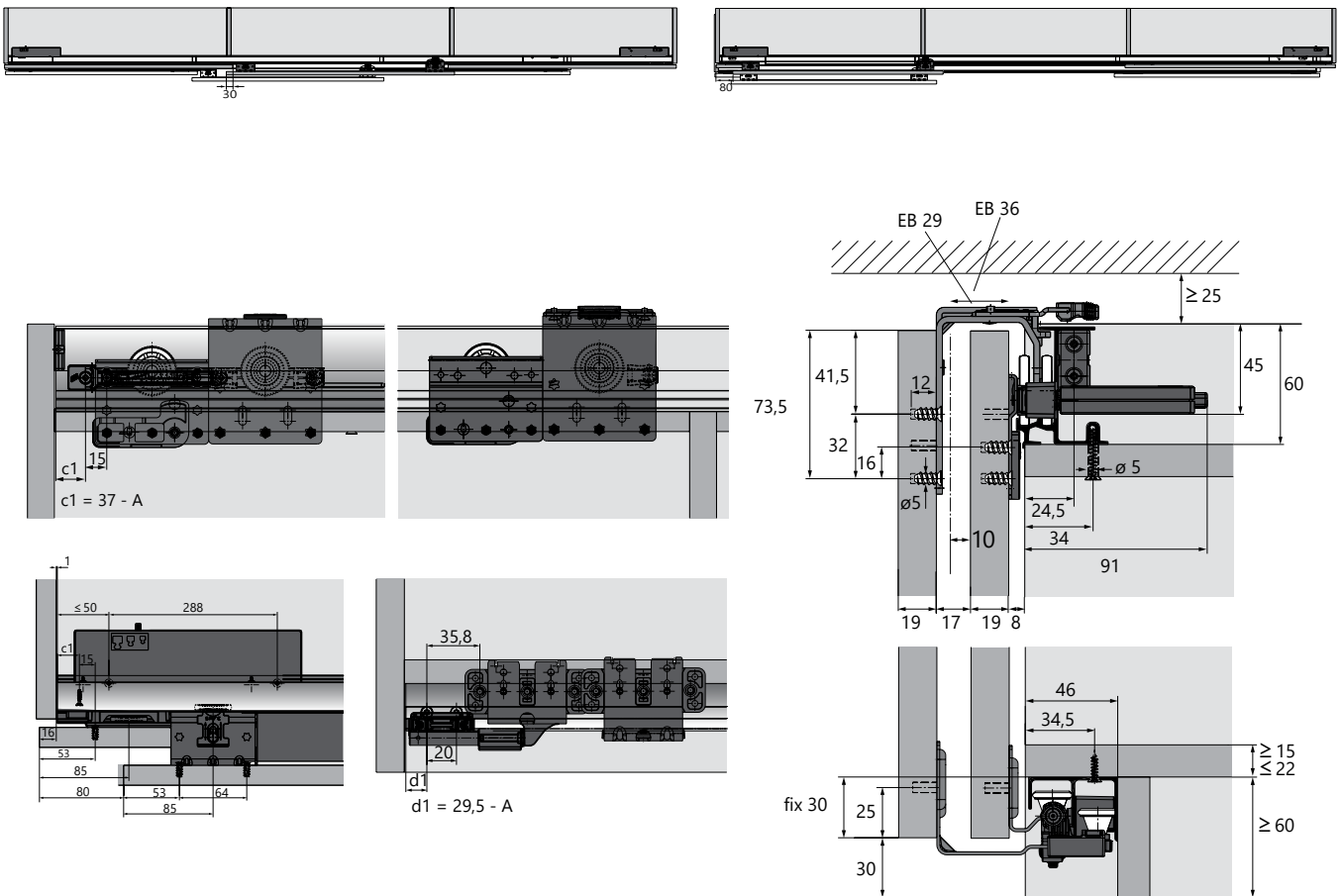



Hemyüz Sürme Gardrop Sistemi

Sliding Door Systems

8888 Seri

Kod/Code	Açıklama/Description
072269	2 Kapak İçin 800 mm Gardrop Hemyüz Sürme Sistem 8888 01
059890	2 Kapak İçin 900 mm Gardrop Hemyüz Sürme Sistem 8888 02
059891	2 Kapak İçin 1100 mm Gardrop Hemyüz Sürme Sistem 8888 04
059892	2 Kapak İçin 1200 mm Gardrop Hemyüz Sürme Sistem 8888 05

TEKNİK DETAYLAR / Details

- > Sistem Üzerinde Kapanış Yönünde Yavaşlatıcı Mevcuttur.
- > Max. 2200 mm Yükseklikteki Komidin veya Dolaplar için Uygundur.
- > Alüminyum Kulp Profilleri Paket İçeriğine Dahil Değildir
- > Tek Kanat Uygulamalar İçin, Lütfen Satış Temsilcilerimizden Bilgi Alınız.

Kulp Profilleri / Handle Profiles

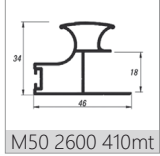

M50 2600 410mt

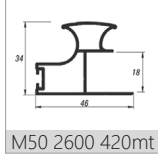

M50 2600 420mt

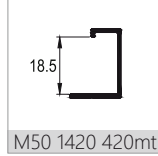

M50 1420 420mt

Opsiyonel Aksesuar / Optional Accessories



M45 0180 011 mt

Teknik Detay / Technical Detail

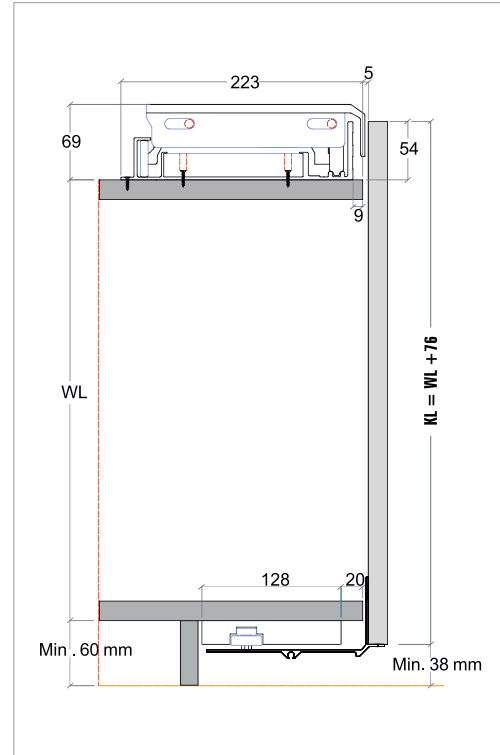

1 Set İçeriği / 1 Set Includes



EVOLUTION





STI System Holz...

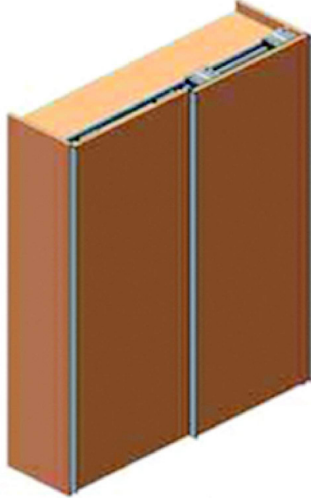

2 Kapak

■ Dış Kapak Seti

2 Kapak İçin
2 Adet



Kod/Code	Açıklama/Description
059826	Evolution 22 mm Kapaklar İçin Dış Kapak Seti
057026	Evolution 28 mm Kapaklar İçin Dış Kapak Seti
059938	Evolution 33 mm Kapaklar İçin Dış Kapak Seti
057025	Evolution 38 mm Kapaklar İçin Dış Kapak Seti
058604	Evolution 50 mm Kapaklar İçin Dış Kapak Seti

■ İç Kapak Seti

2 Kapak İçin
2 Adet



Kod/Code	Açıklama/Description
057027	Evolution İç Kapaklar İçin Standart Kit

■ Üst Fren Mekanizması

2 Kapak İçin
4 Adet



Kod/Code	Açıklama/Description
057033	Evolution Sürgü Kapak Üst Yavaşlatıcı Mekanizma

■ Yavaşlatıcı Mekanizması

2 Kapak İçin
2 Adet

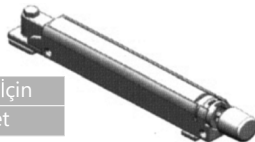

Kod/Code	Açıklama/Description
057034	Evolution Sürgü Kapak Alt Yavaşlatıcı Mekanizma

■ Mekanizma Stoperi

2 Kapak İçin
2 Adet



Kod/Code	Açıklama/Description
057220	Evolution Yavaşlatıcı Mekanizma Tutucusu

Evolution Kayar Kapak Sistemleri

2 Kapaklı Katlanır Kapak Sistemleri (70 Kg)
Evolution Sliding Door System With Soft Close

Kod/Code	Açıklama/Description
SH-2-22	Evolution 2 Kapaklı 22 mm Paket Sistem
SH-2-28	Evolution 2 Kapaklı 28 mm Paket Sistem
SH-2-33	Evolution 2 Kapaklı 33 mm Paket Sistem
SH-2-38	Evolution 2 Kapaklı 38 mm Paket Sistem
SH-2-50	Evolution 2 Kapaklı 50 mm Paket Sistem

TEKNİK DETAYLAR / Details

- > Tek Kapak İçin Max. Taşıma Kapasitesi
- > Paket İçeriğine 3m Ray Dahil Edilmiştir

■ Üst Kapak Rayı

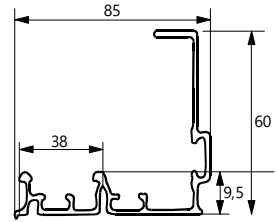

Kod/Code	Açıklama/Description
057040	Evolution Üst Kapak Rayı Alüminyum 2 m
057036	Evolution Üst Kapak Rayı Alüminyum 3 m
057038	Evolution Üst Kapak Rayı Alüminyum 4 m

■ Alt Kapak Rayı

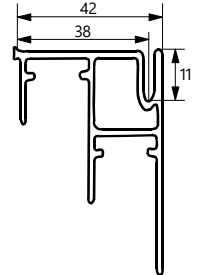

Kod/Code	Açıklama/Description
057039	Evolution Alt Kapak Rayı Alüminyum 2 m
057035	Evolution Alt Kapak Rayı Alüminyum 3 m
057037	Evolution Alt Kapak Rayı Alüminyum 4 m

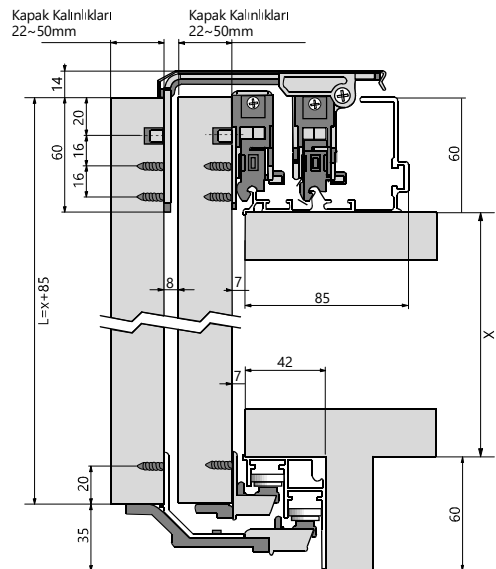

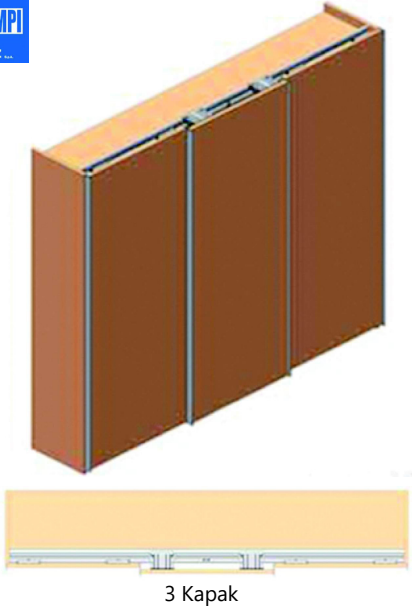

3 Kapak

■ Dış Kapak Seti

3 Kapak İçin
2 Adet



Kod/Code	Açıklama/Description
059826	Evolution 22 mm Kapaklar İçin Dış Kapak Seti
057026	Evolution 28 mm Kapaklar İçin Dış Kapak Seti
059938	Evolution 33 mm Kapaklar İçin Dış Kapak Seti
057025	Evolution 38 mm Kapaklar İçin Dış Kapak Seti
058604	Evolution 50 mm Kapaklar İçin Dış Kapak Seti

■ İç Kapak Seti

3 Kapak İçin
4 Adet



Kod/Code	Açıklama/Description
057027	Evolution İç Kapaklar İçin Standart Kit

■ Üst Fren Mekanizması

3 Kapak İçin
6 Adet



Kod/Code	Açıklama/Description
057033	Evolution Sürgü Kapak Üst Yavaşlatıcı Mekanizma

■ Yavaşlatıcı Mekanizması

3 Kapak İçin
2 Adet



Kod/Code	Açıklama/Description
057034	Evolution Sürgü Kapak Alt Yavaşlatıcı Mekanizma

■ Mekanizma Stoperi

3 Kapak İçin
4 Adet



Kod/Code	Açıklama/Description
057220	Evolution Yavaşlatıcı Mekanizma Tutucusu

Evolution Kayar Kapak Sistemleri
3 Kapaklı Katlanır Kapak Sistemleri (70 Kg)
Evolution Sliding Door System With Soft Close

Kod/Code	Açıklama/Description
SH-3-22	Evolution 3 Kapaklı 22 mm Paket Sistem
SH-3-28	Evolution 3 Kapaklı 28 mm Paket Sistem
SH-3-33	Evolution 3 Kapaklı 33 mm Paket Sistem
SH-3-38	Evolution 3 Kapaklı 38 mm Paket Sistem
SH-3-50	Evolution 3 Kapaklı 50 mm Paket Sistem

TEKNİK DETAYLAR / Details

- > Tek Kapak İçin Max. Taşıma Kapasitesi
- > Paket İçeriğine 3m Ray Dahil Edilmiştir

■ Üst Kapak Rayı

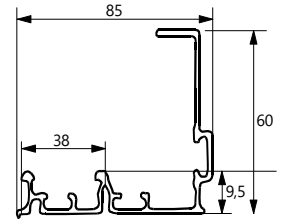

Kod/Code	Açıklama/Description
057040	Evolution Üst Kapak Rayı Alüminyum 2 m
057036	Evolution Üst Kapak Rayı Alüminyum 3 m
057038	Evolution Üst Kapak Rayı Alüminyum 4 m

■ Alt Kapak Rayı

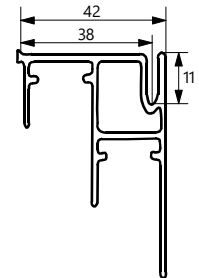

Kod/Code	Açıklama/Description
057039	Evolution Alt Kapak Rayı Alüminyum 2 m
057035	Evolution Alt Kapak Rayı Alüminyum 3 m
057037	Evolution Alt Kapak Rayı Alüminyum 4 m

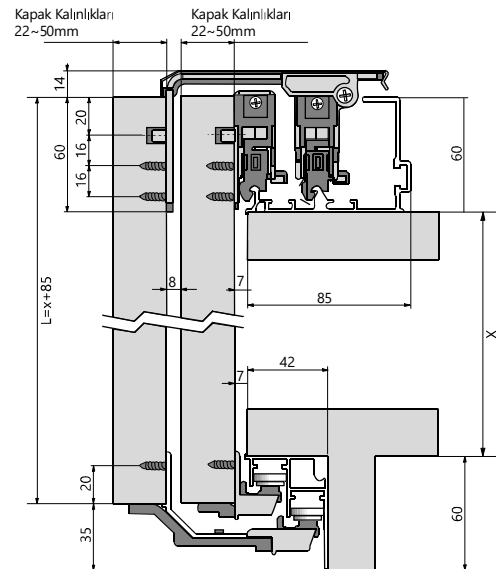

Kayar Kapak Sistemleri

Dış Kapak Taşıyıcı, Yavaşlatıcı Kılavuz Montaj Ölçüleri
Evolution Sliding Door System



Evolution Kapak Mekanizma Ölçüleri
22-28-33-38-50

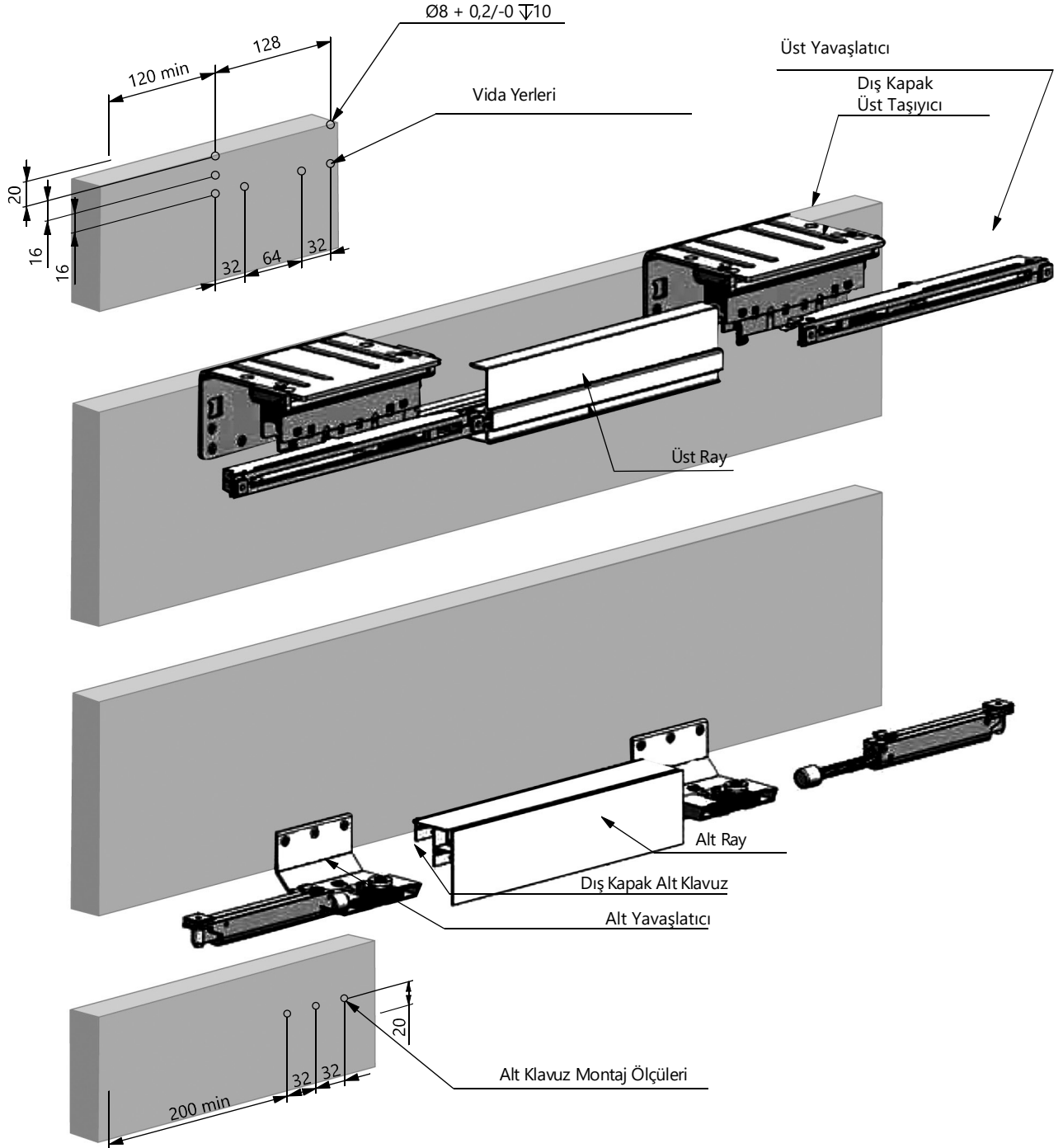

Evolution Kayar Kapak Sistemleri

İç Kapak Taşıyıcı, Yavaşlatıcı ve Alt Kılavuz Montaj Ölçüleri
Evolution Sliding Door System

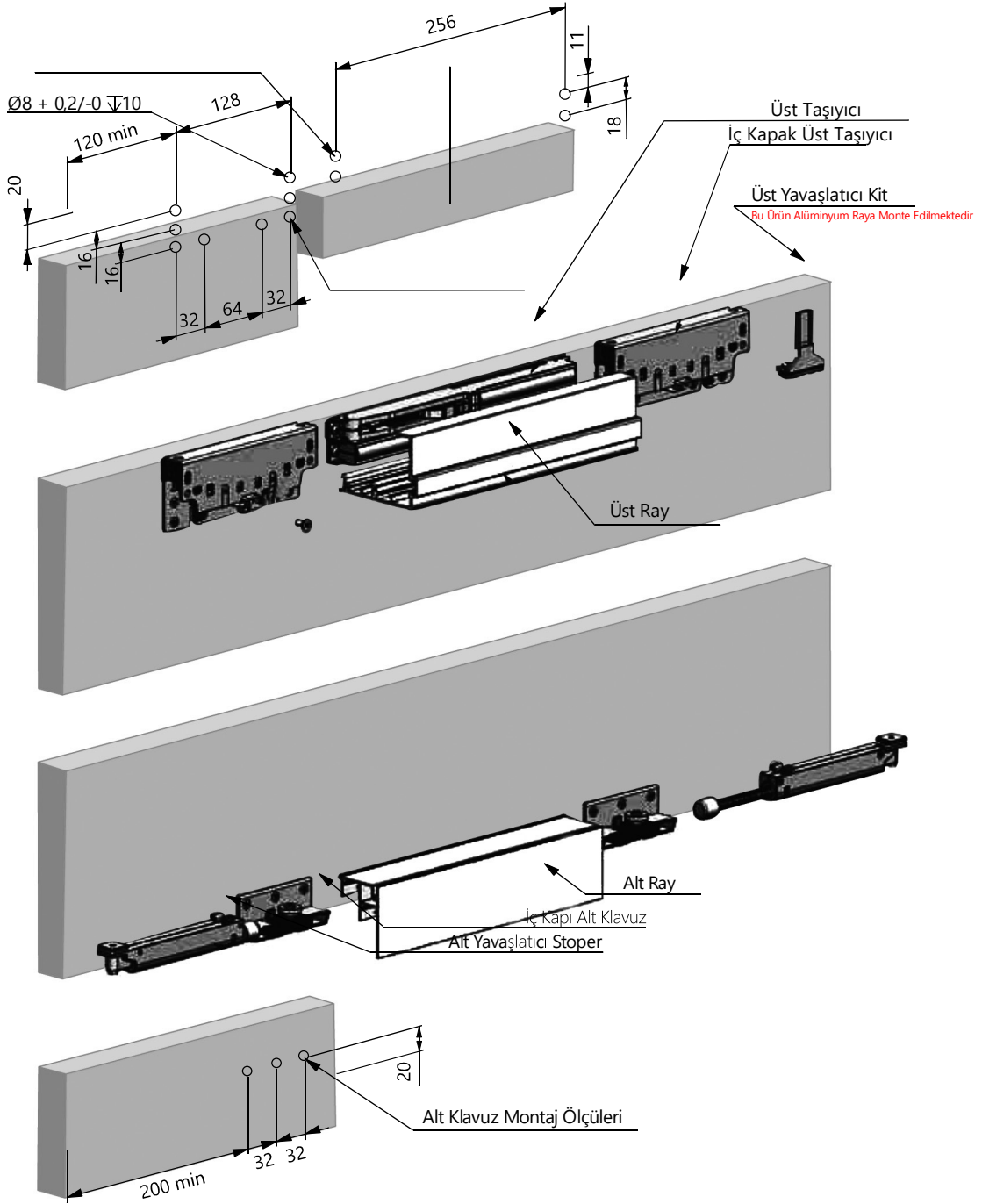

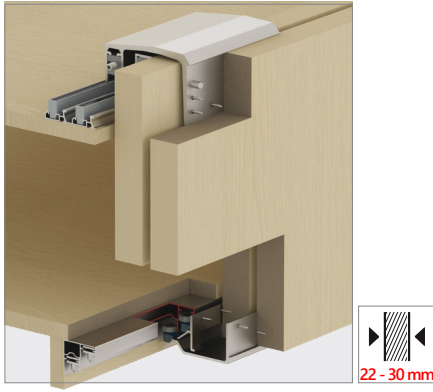

Önde Kayan Kapak Sistemleri
Önde Kayan Kapak Sistemleri (100 Kg)
Sliding Door System With Soft Close

Kod/Code	Açıklama/Description
ALB - 8230	2 Kapaklı 22 - 30 mm Yavaştırıcı Paket Sistem
ALB - 8230 - 3	3 Kapaklı 22 - 30 mm Yavaştırıcı Paket Sistem

TEKNİK DETAYLAR / Details

- > Tek Kapak İçin Max. Taşıma Kapasitesi
- > 3 Kapaklı 16 - 20 mm Yavaştırıcı Paket Sistem

M02 8220 SFT 1 Set İçeriği / 1 Set Includes



Teknik Detay / Details

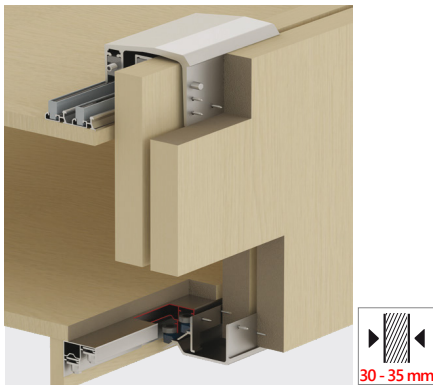
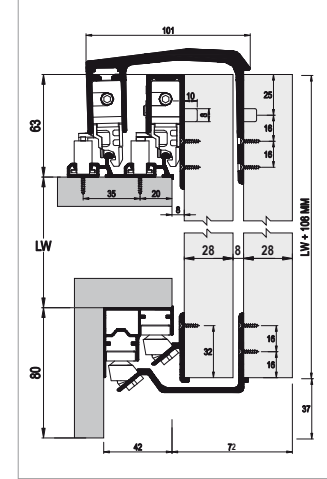

Önde Kayan Kapak Sistemleri
Önde Kayan Kapak Sistemleri (100 Kg)
Sliding Door System With Soft Close

Kod/Code	Açıklama/Description
ALB - 8235	2 Kapaklı 30 - 35 mm Yavaştırıcı Paket Sistem
ALB - 8235 - 3	3 Kapaklı 22 - 35 mm Yavaştırıcı Paket Sistem

TEKNİK DETAYLAR / Details

- > Tek Kapak İçin Max. Taşıma Kapasitesi
- > 3 Kapaklı 30 - 35 mm Yavaştırıcı Paket Sistem

M02 8235 SFT 1 Set İçeriği / 1 Set Includes

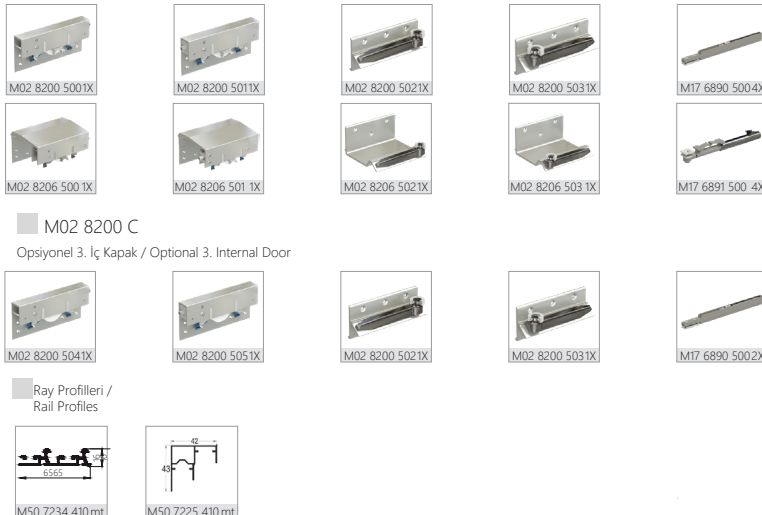

Teknik Detay / Details

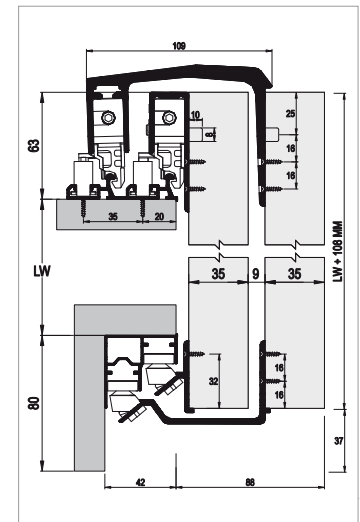

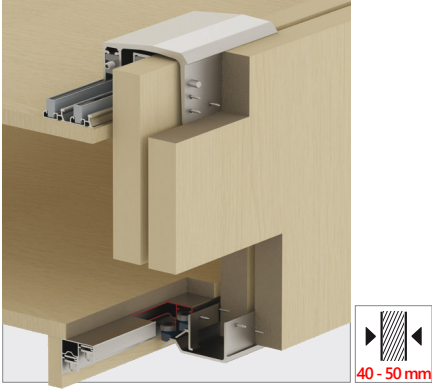

M02 8250 SFT 1 Set İçeriği / 1 Set Includes



M02 8200 C
Opsiyonel 3. İç Kapak / Optional 3. Internal Door



Ray Profilleri /
Rail Profiles

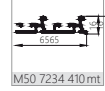

Kulp Profilleri /
Handle Profiles



Opsiyonel Aksesuar /
Optional Accessories



Kod/Code	Açıklama/Description
ALB - 8250	2 Kapaklı 40 - 50 mm Yavaşlatıcı Paket Sistem
ALB - 8250 - 3	3 Kapaklı 40 - 50 mm Yavaşlatıcı Paket Sistem

TEKNİK DETAYLAR / Details

- > Tek Kapak İçin Max. Taşıma Kapasitesi
- > 3 Kapaklı 40 - 50 mm Yavaşlatıcı Paket Sistem

Teknik Detay / Details

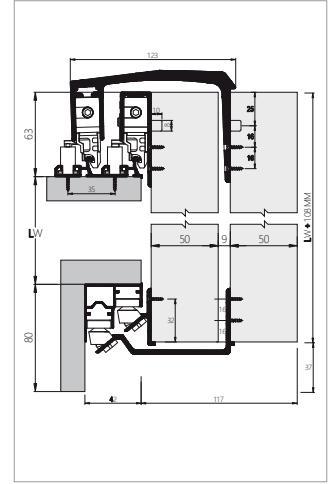

M02 8220 3K 1 Set İçeriği / 1 Set Includes



M02 8200 C
Opsiyonel 3. İç Kapak / Optional 3. Internal Door



Ray Profilleri /
Rail Profiles

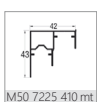
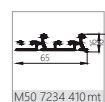

Kulp Profilleri /
Handle Profiles

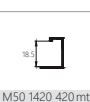
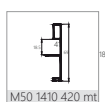
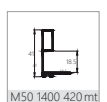

Opsiyonel Aksesuar /
Optional Accessories



Kod/Code	Açıklama/Description
ALB - 8229 - 3K	3 Kapaklı 16 - 20 mm Yavaşlatıcı Paket Sistem

TEKNİK DETAYLAR / Details

- > Tek Kapak İçin Max. Taşıma Kapasitesi
- > Set İçerisinde 2 İç Kapak 1 Dış Kapak Bulunur
- > 16 - 20 Kapak Kalınlıkları İçin kullanılır

Teknik Detay / Details

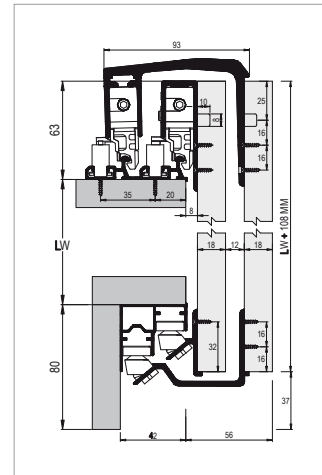

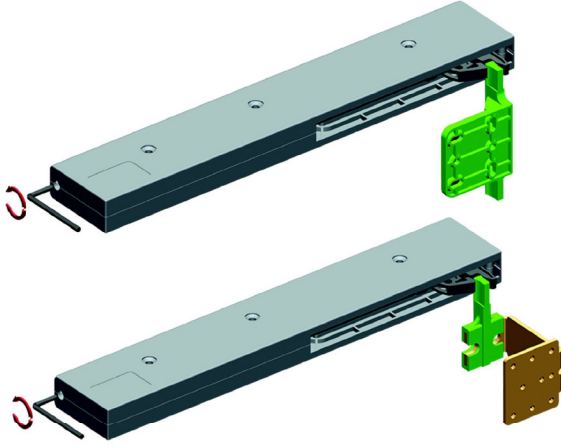

Otomatik Kapatma Sistemi
6666 Seri (60 Kg)
Soft Closing Device

Kod/Code	Açıklama/Description
062864	Otomatik Kapak Frenleme Sistemi 6666

TEKNİK DETAYLAR / Details

- > 6666 IK 01 İç Kapak Uzun Tutucu,
6666 IK 02 İç Kapak Kısa Tutucu,
6666 DK 03 (18 - 22 mm) Dış Kapak Uzun Tutucu
6666 DK 04 (18 - 28 mm) Dış Kapak Uzun Tutucu
6666 DK 01 (18 - 22 mm) Dış Kapak Kısa Tutucu
6666 DK 02 (18 - 28 mm) Dış Kapak Kısa Tutucu
Paket İçeriğine Dahildir.

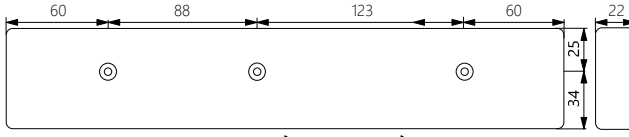

> Dış Kapak ve İç Kapak Tutucuları Yavaşlatıcı Mekanizmaya Bağlamak İçin Kapağa Uygun Alanı Seçiniz.

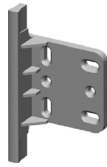
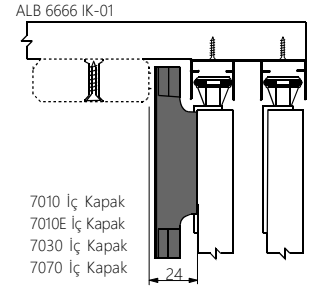

İç Kapak Tutucu
6666 IK 01
6666 IK 02

Takım
1 Adet

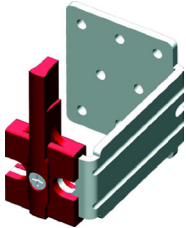

Dış Kapak Tutucu
6666 DK 01 (18-22 mm)
6666 DK 02 (18-28 mm)
6666 DK 03 (18-22 mm)
6666 DK 04 (18-28 mm)

Takım
1 Adet

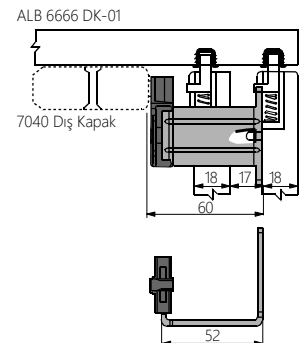
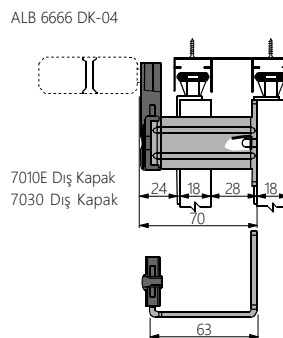
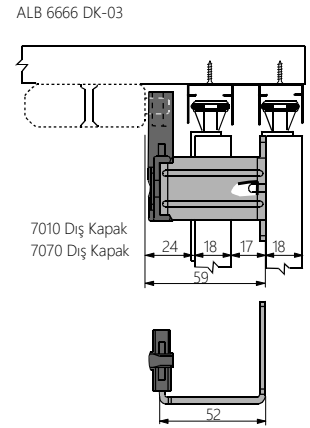
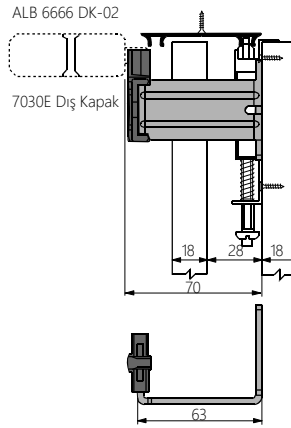

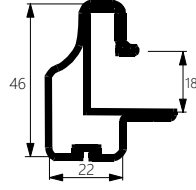
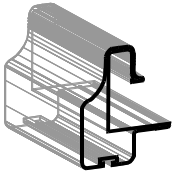
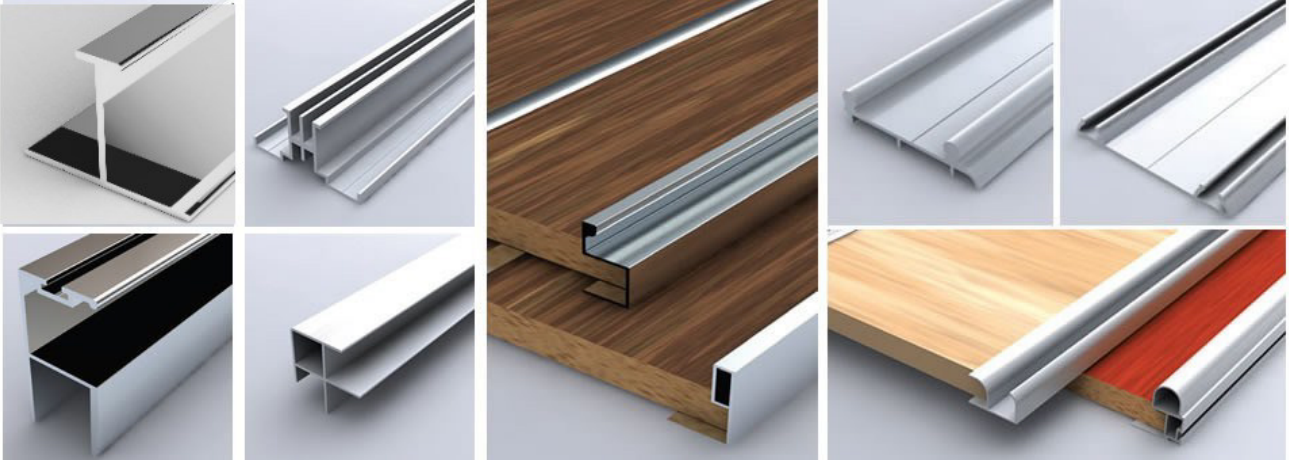

2500 Seri
Kulp Profili 18 mm
Handle Profiles

Kod/Code	Açıklama/Description
070914	Alüminyum Kulp Profili 2,5m - 18 mm 2500

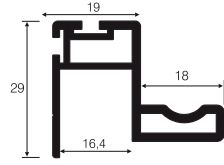
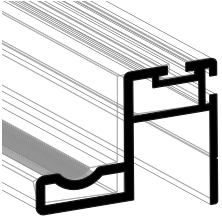

112 Seri
Kulp Profili 18 mm
Handle Profiles

Kod/Code	Açıklama/Description
119006	Alüminyum Kulp Profili 2,5m - 18 mm 112-01-25-621

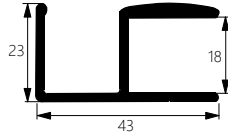
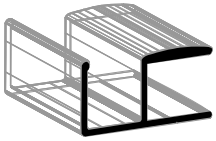

2523 Seri
Kulp Profili 18 mm
Handle Profiles

Kod/Code	Açıklama/Description
058610	Alüminyum Kulp Profili 2,5m - 18 mm 2523

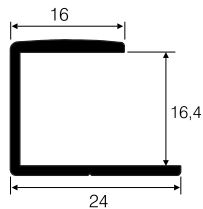

1120325 Seri
Kulp Profili 18 mm
Handle Profiles

Kod/Code	Açıklama/Description
119008	Parlak Alüminyum Kulp Profili 2,5m - 18 mm 112-03-25-601

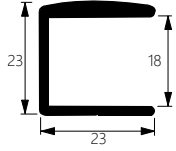
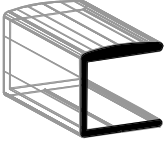

2524 Seri
Kulp Profili 18 mm
Handle Profiles

Kod/Code	Açıklama/Description
070913	Parlak Alüminyum Kulp Profili 2,5m - 18 mm 2524

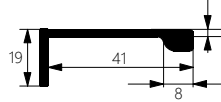
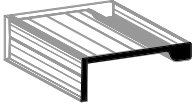

102 Seri
Kulp Profili 19 mm
Handle Profiles

Kod/Code	Açıklama/Description
071419	Parlak Alüminyum L Boy Kulp 3m - 19 mm KR 102

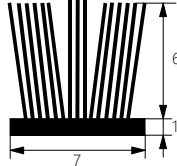
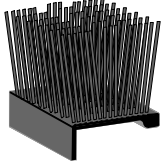

Alüminyum Sürme Kapak Fiteli
018011
Aluminium Door Wick

Kod/Code	Açıklama/Description
072277	Alüminyum Sürme Kapak Fiteli 100m Gri

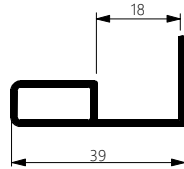
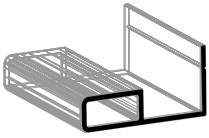

2526 Seri
Kulp Profili 18 mm
Handle Profiles

Kod/Code	Açıklama/Description
070915	Parlak Alüminyum Kulp Profili 2,5m - 18 mm 2526

Kayar Kapak Sistemleri
Kenar Kulp Uygulaması
Sliding Door System With Handle

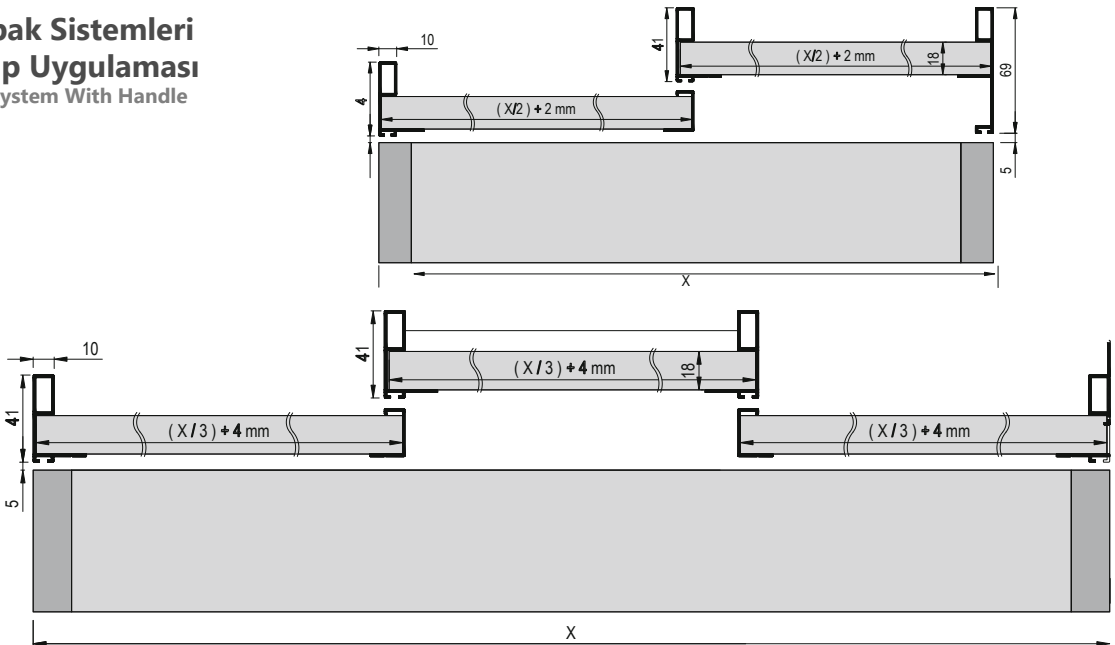



Yavaşlatıcı Sistem - Ahşap İçin Soft Closing System

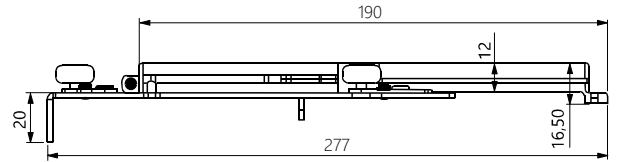
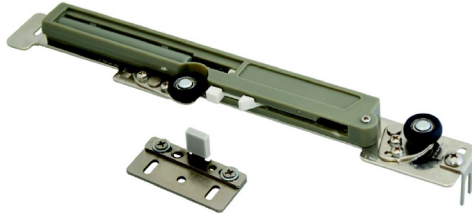

Kod/Code	Açıklama/Description
055368	SOHO Sürgü Kapak Yavaşlatıcı Sistem Alüm - Ahşap

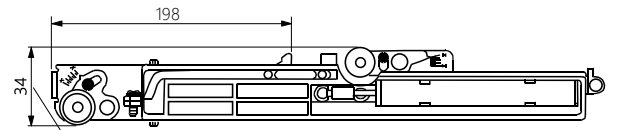

34-42 mm'lik Üst Raya Ayarlanabilir
Yavaşlatıcı Mekanizma

Yavaşlatıcı Sistem - Alüminyum İçin Soft Closing System

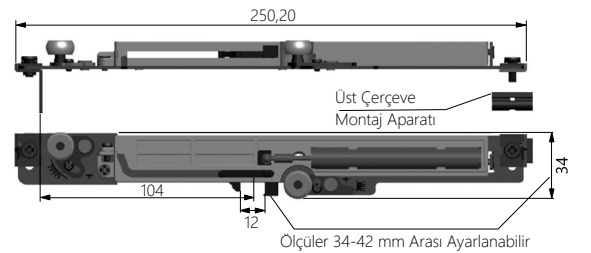
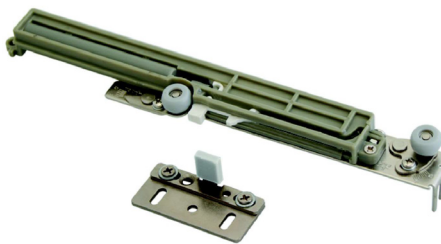

Kod/Code	Açıklama/Description
054545	SOHO Sürgü Kapak Yavaşlatıcı Sistem Alüminyum

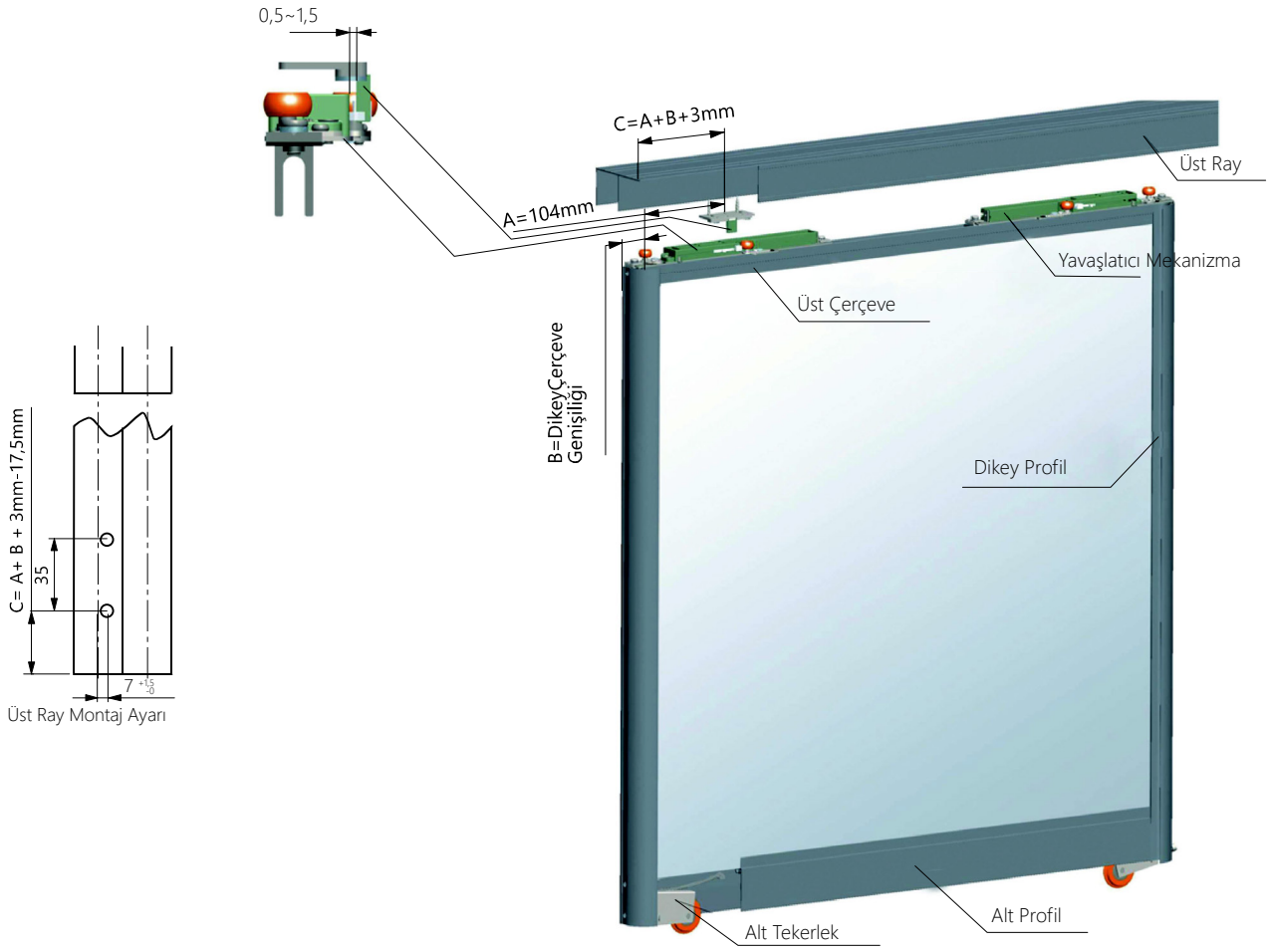

- > SOHO-HC02 Yumuşak Kapanan Mekanizma Hem Simetrik Hemde Anizometrik Profillerde (0 - 9 mm) Kullanılabilir, Sağ ve Sol Tekerleklerle Ayarlanabilir
- > 80.000 Test Sayısını Aşmıştır.

32 mm Profile Uygundur

Alt Makara Bottom Roller



Kod/Code	Açıklama/Description
054546	SOHO Sürgü Kapak Alt Makara

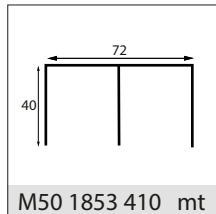

Kod/Code	Açıklama/Description
066302	SOHO Sürgü Kapak Üst Ray 3 mt

Üst Kılavuz Tekerli Upper Roller



Kod/Code	Açıklama/Description
055590	SOHO Sürgü Kapak (Dengeleyici) Kılavuz Teker

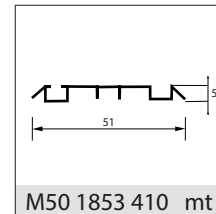

Kod/Code	Açıklama/Description
066303	SOHO Sürgü Kapak Alt Ray 3 mt

EKU FRONTINO® 20

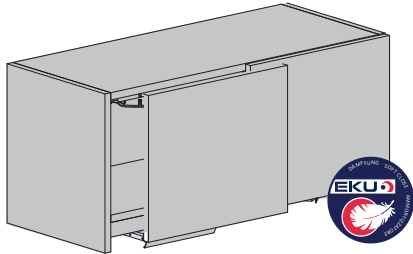

Eku Frontino 20
Wooden Sliding Door System

Kod/Code	Typ	Açıklama/Description	E mm	D mm
317018	TYP S1	KAM 1200 - 1399mm	231	97
317019	TYP S2	KAM 1400 - 1599mm	281	147
317020	TYP S3	KAM 1600 - 1799mm	331	197
317021	TYP S4	KAM 1800 - 1999mm	381	247
317022	TYP S5	KAM 2000 - 2199mm	431	297
317023	TYP S6	KAM 2200 - 2400mm	481	347

> 20 kg iki kapaklı kapılar için tasarlanmış vidalı alttan çalışan sistem

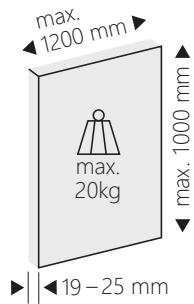

Uygulama:

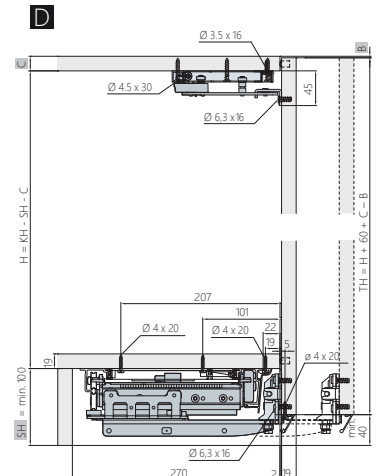
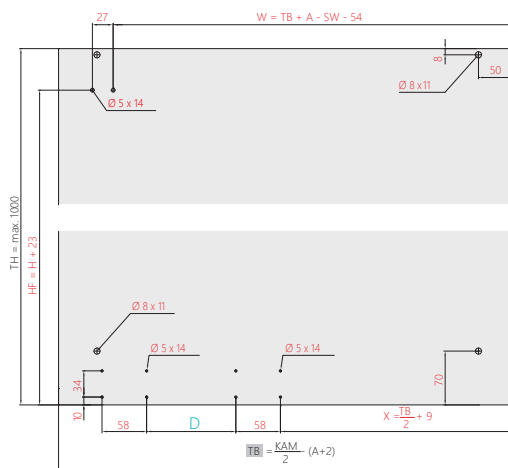

TH = Kapak Yüksekliği
TB = Kapak Genişliği
W = Kılavuz Pozisyonu
HF = Kılavuz Yüksekliği
X = Sabitleme
KP = Pozisyon Radyal Kam



EKU FRONTINO® 20

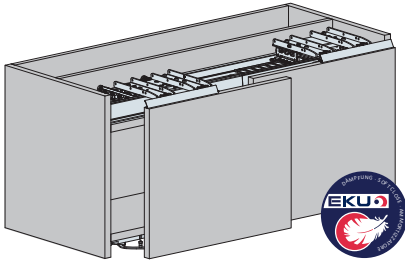

Eku Frontino 20 H OS Forslide (FS)
Wooden Sliding Door System

Kod/Code	Typ	Açıklama/Description	E mm	D mm
317025	TYP S1	KAM 1200 - 1399mm	231	97
317026	TYP S2	KAM 1400 - 1599mm	281	147
317027	TYP S3	KAM 1600 - 1799mm	331	197
317028	TYP S4	KAM 1800 - 1999mm	381	247
317029	TYP S5	KAM 2000 - 2199mm	431	297
317030	TYP S6	KAM 2200 - 2400mm	481	347

> 20 kg iki kapaklı kapılar için tasarlanmış vidalı üstten çalışan sistem

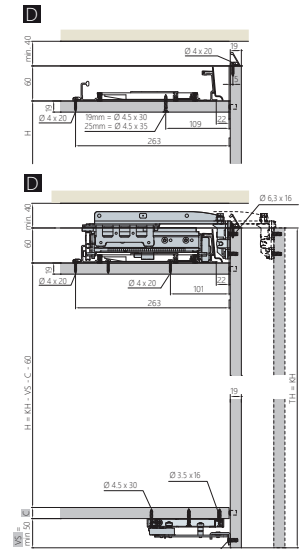
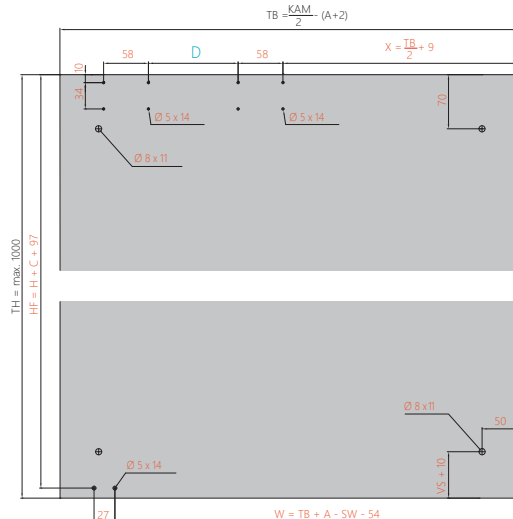
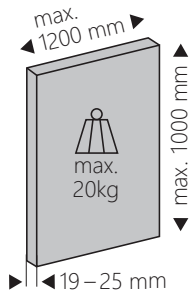

- TH = Kapak Yüksekliği
- TB = Kapak Genişliği
- W = Kılavuz Pozisyonu
- HF = Kılavuz Yüksekliği
- X = Sabitleme
- KP = Pozisyon Radyal Kam

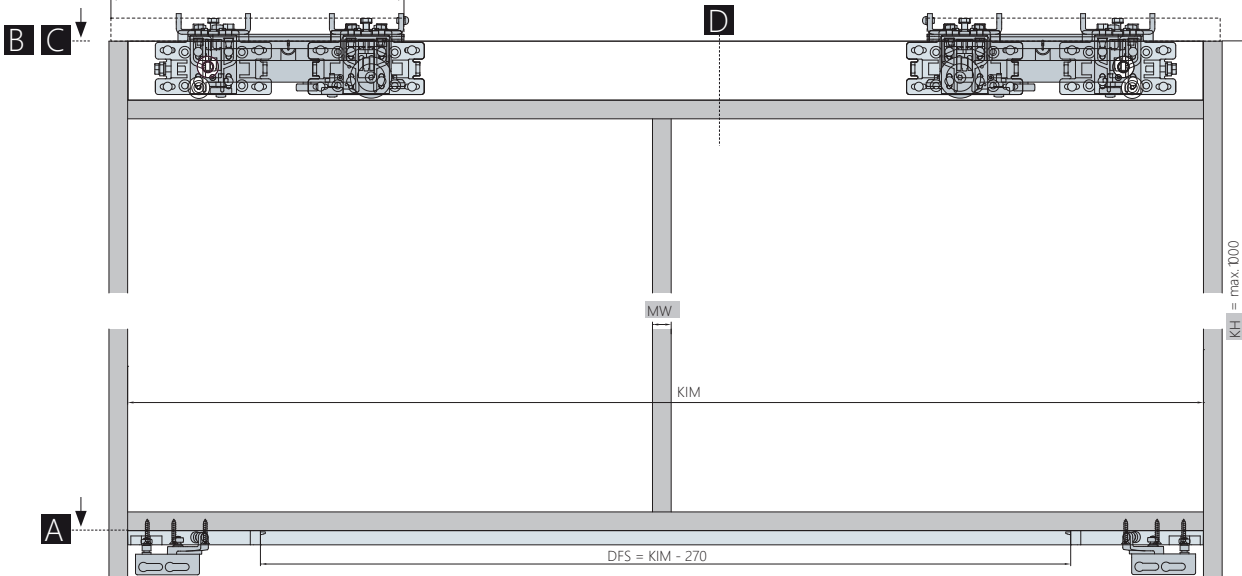
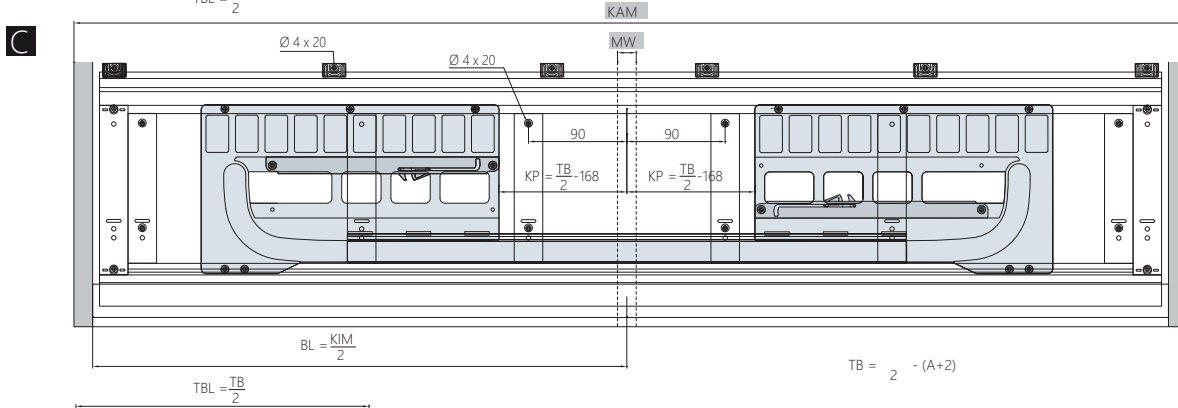
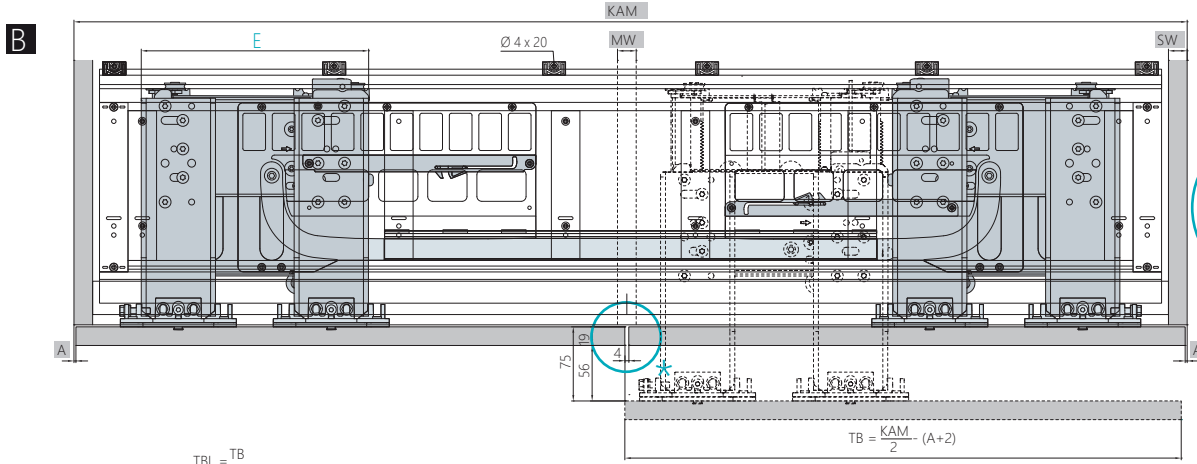
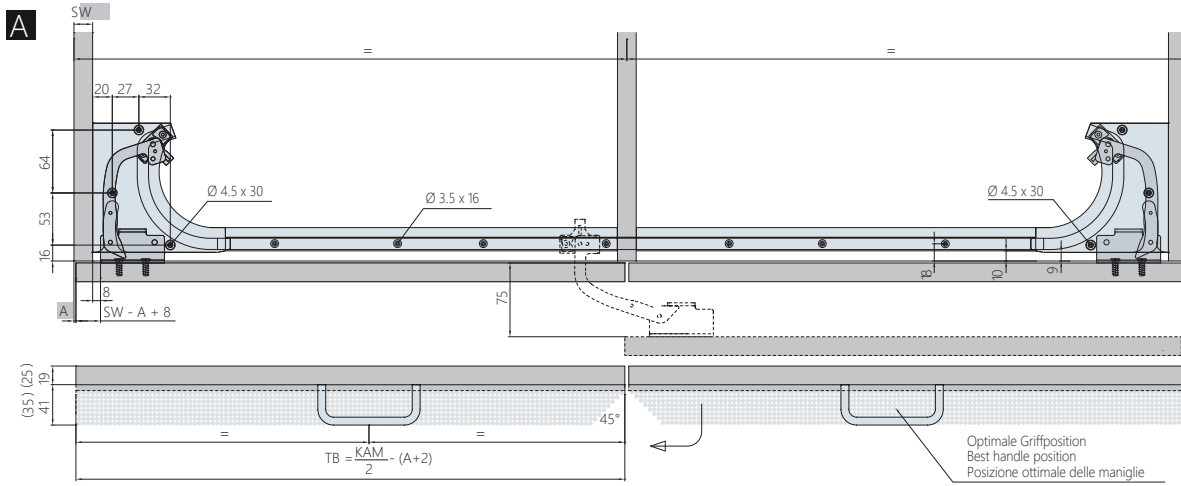

İçte Kayan Kapak Sistemleri

2/3 Kapaklı Kayar Kapak Sistemleri (20/35 Kg)

Sliding Door System With Soft Closing



3 Kapak İçin Orta Durdurucu

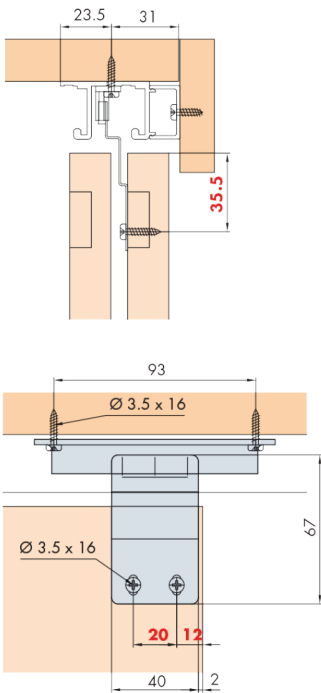

> Paket İçeriği

2 Kapak	20 No. 056.3180.071 35 No. 056.3180.073	3 Kapak	20 No. 056.3180.075 35 No. 056.3180.077
COMBINO 20 4x	COMBINO 35 4x	COMBINO 20 6x	COMBINO 35 6x
2x	2x	3x	1x
4x	1x	6x	3x
2x	2x	3x	1x

Üst Ray Tekli Alüminyum
056.3011.250 - 2500mm
056.3011.350 - 3500mm
056.3011.600 - 6000mm

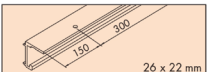

Üst Ray Çiftli Alüminyum
056.3010.250 - 2500mm
056.3010.350 - 3500mm
056.3010.600 - 6000mm

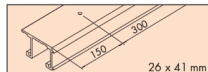

Alüminyum Ray Kapağı
056.3174.250 - 2500mm
056.3174.350 - 3500mm
056.3174.600 - 6000mm



Alüminyum Ek Parça
056.3039.001



Alüminyum Klavuz
053.3074.250 - 2500mm
053.3074.350 - 3500mm
053.3074.600 - 6000mm

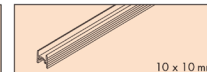

Stoper
056.3035.071

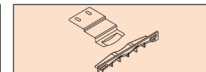



EKU COMBINO®
60 H INSLIDE (IS)

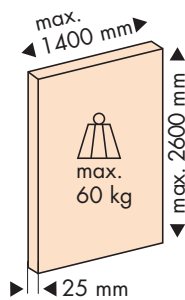
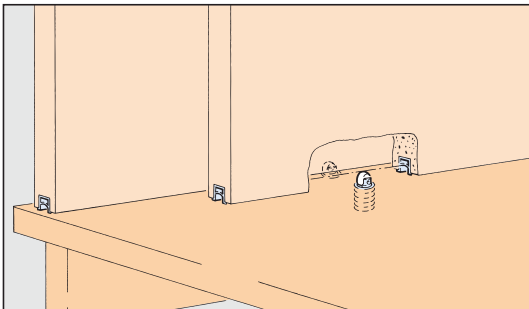
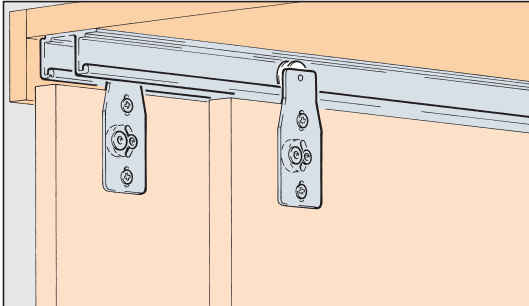

İçte Kayan Kapak Sistemleri (60 Kg) Sliding Door System With Soft Closing

Kod/Code	Açıklama/Description
332752	EKU 055.3093.071 60 kg 2 Kapaklı Sistem
332753	EKU 056.3180.072 60 kg 3 Kapaklı Sistem

TEKNİK DETAYLAR / Details

- > 60 kg Ağırlığındaki 2/3 Kapaklı Sistemler İçin Tasarlanmıştır
- > Max. Kapak Geniřliđi: 1400 mm
- > Max. Kapak Yüksekliđi: 2600 mm
- > Max. Kapak Ađırlıđı: 60 kg
- > Max. Kapak Kalınlıđı: 25 mm

2 Kapak Uygulama

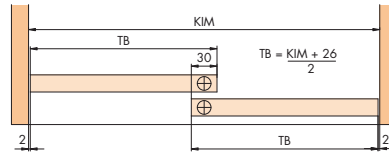

3 Kapak Uygulama

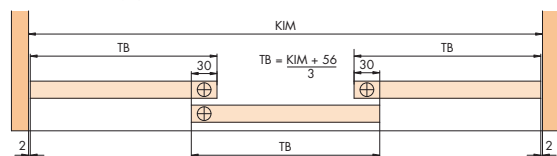

Kayar Kapak Sistemleri

İçte Kayan Kapak Sistemleri (60 Kg)
Sliding Door System With Soft Closing



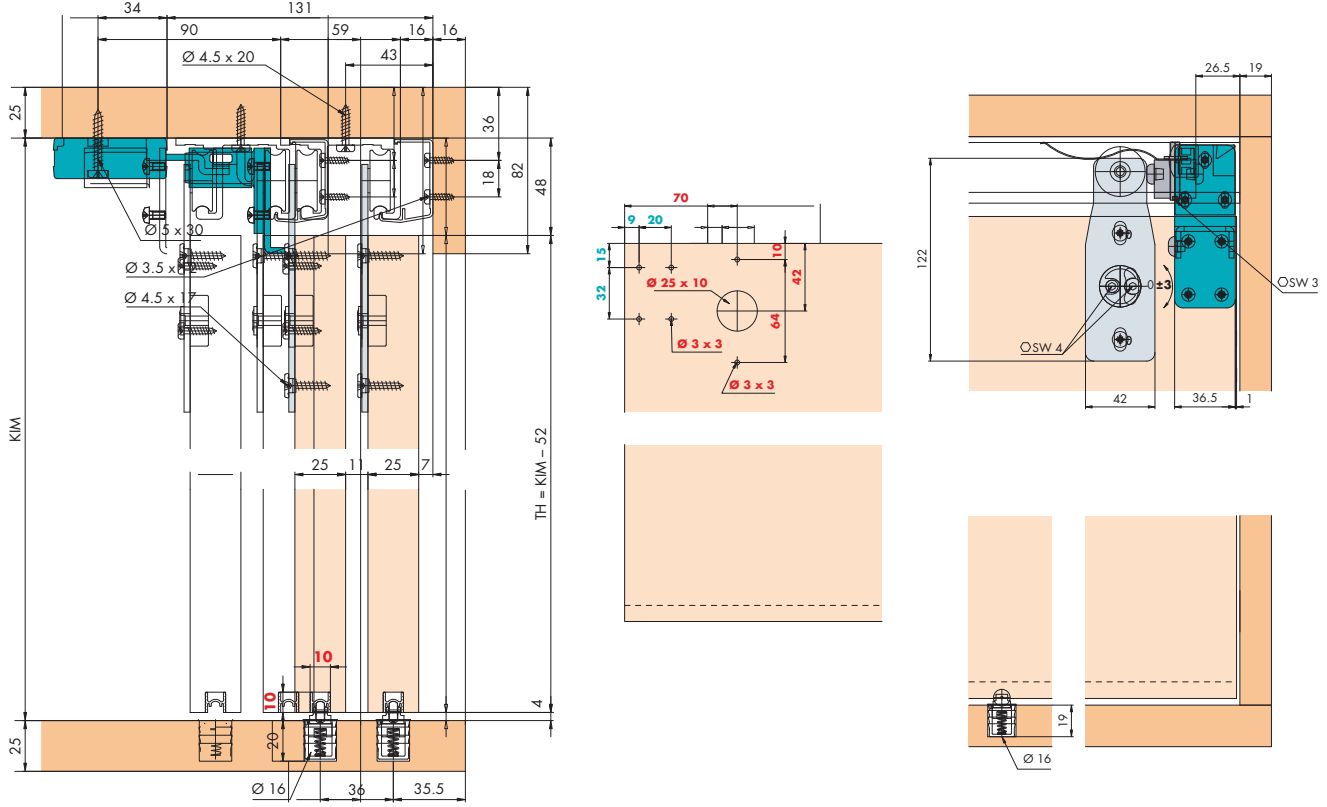



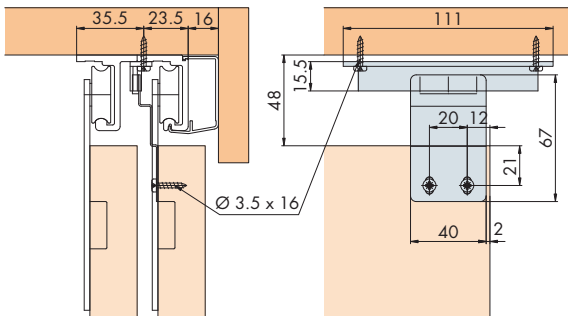

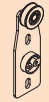

Uygulama Örneği



3 Kapak İçin Orta Durdurucu



> Paket İçeriği

2 Kapak No. 055.3093.071		3 Kapak No. 055.3093.072	
	4x		6x
	4x		4x
	2x		3x
	8x		12x
	2x		3x
	1x		3x

Üst Ray Tekli Alüminyum
055.3001.250 - 2500mm
055.3001.350 - 3500mm
055.3001.600 - 6000mm

Üst Ray Çiftli Alüminyum
055.3000.250 - 2500mm
055.3000.350 - 3500mm
055.3000.600 - 6000mm

Alüminyum Klavuz
053.3074.250 - 2500mm
053.3074.350 - 3500mm
053.3074.600 - 6000mm

Alüminyum Ek Parça
055.3084.001 - 2500mm

Stoper
056.3035.071

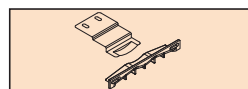
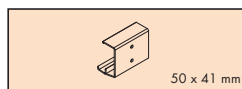
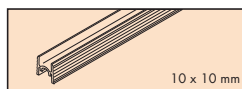
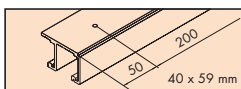



Kayar Kapak Sistemleri

2 Kapaklı Kayar Kapak Sistemleri (60 Kg)
Sliding Door System With Soft Closing

Kod/Code	Açıklama/Description
ALB-SRG 100	2 Kapaklı 22 mm Yavaşlatıcı Paket Sistem
ALB-SRG 100-3	3 Kapaklı 22 mm Yavaşlatıcı Paket Sistem
088133	Alüminyum Üst Ray 3 mt
143657	Alüminyum Alt Ray 3 mt
088304	Alüminyum Parlak Kenar Kulbu 3 mt

TEKNİK DETAYLAR / Details

- > Tek Kapak İçin Max. Taşıma Kapasitesi
- > 18 - 22 mm Kapak Kalınlıklarında Kullanılır

M03 SRG 100 1 Set İçeriği / 1 Set Includes

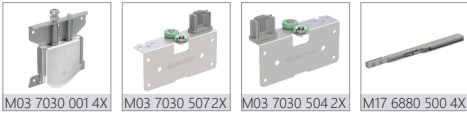

M03 SRG 100 C Opsiyonel 3. İç Kapak / Optional 3. Internal Door

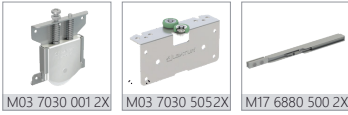

Ray Profilleri / Rail Profiles

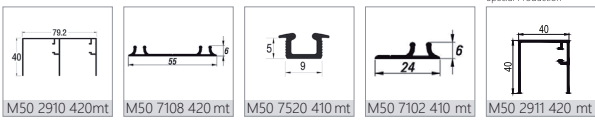

Kulp Profilleri / Handle Profiles

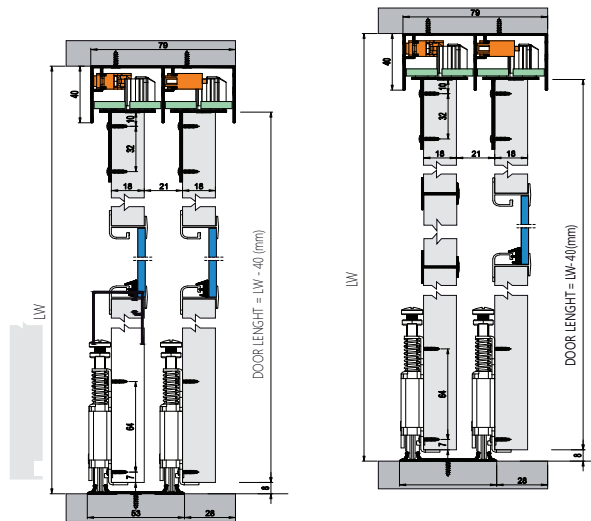



Kayar Kapak Sistemleri

2 Kapaklı Kayar Kapak Sistemleri (70 Kg)

Sliding Door System With Sof Closing

Kod/Code	Açıklama/Description
ALB-SRG 110	2 Kapaklı 22 mm Yavaşlatıcılı Paket Sistem
316988	Alüminyum Üst Ray 2 mt
059951	Alüminyum Alt Ray 2 mt
058610	Alüminyum Mat Kenar Kulbu 2.5 mt

TEKNİK DETAYLAR / Details

- > Tek Kapak İçin Max. Taşıma Kapasitesi
- > 18 - 20 mm Kapak Kalınlıklarında Kullanılır

M03 SRG 110

1 Set İçeriği / 1 Set Includes



M03 7030 001 4X



M03 7038 5002X



M03 7038 5012X



M17 6740 500 4X

Ray Profilleri / Rail Profiles

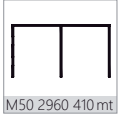

M50 2960 410 mt



M50 7108 410 mt



M50 7520 410 mt

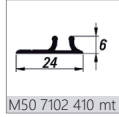

M50 7102 410 mt

Kulp Profilleri / Handle Profiles



M50 2523 410 mt



M50 2524 410 mt

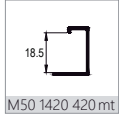

M50 1420 420 mt

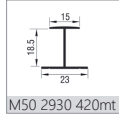

M50 2930 420 mt

Teknik Detay / Details

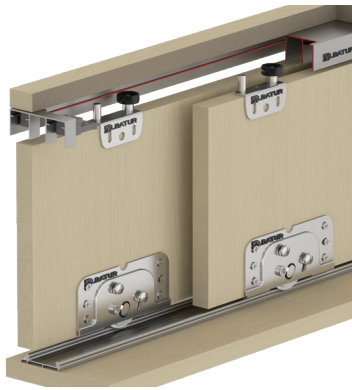
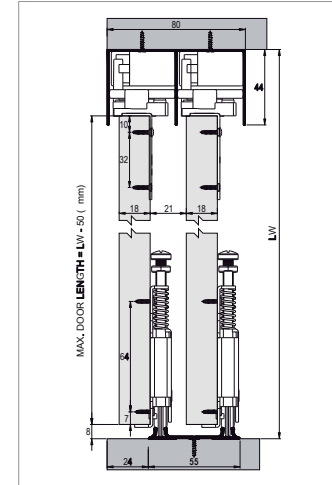

Kayar Kapak Sistemleri

2 Kapaklı Kayar Kapak Sistemleri (70 Kg)

Evolution Sliding Door System With Soft Closing

Kod/Code	Açıklama/Description
ALB-7010 SFT	2 Kapaklı 22 mm Yavaşlatıcılı Paket Sistem
066302	Alüminyum Üst Ray 3 mt
066303	Alüminyum Alt Ray 3 mt
058610	Alüminyum Mat Kenar Kulbu 3 mt

TEKNİK DETAYLAR / Details

- > Tek Kapak İçin Max. Taşıma Kapasitesi
- > 18 - 22 mm Kapak Kalınlıklarında Kullanılır

M03 7010 SFT

1 Takım İçeriği / 1 Set Includes



M03 7010 500 2X



M03 7030 508 1X



M03 7030 509 1X



M03 7030 510 2X

Ray Profilleri / Rail Profiles

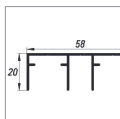

M50 7002 410 mt

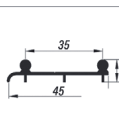

M50 7003 410 mt

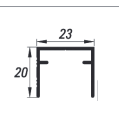

M50 7100 410 mt

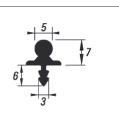

M50 7104 410 mt

Kulp Profilleri / Handle Profiles

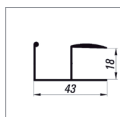

M50 2523 410 mt

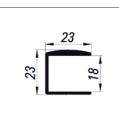

M50 2524 410 mt

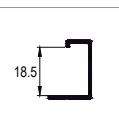

M50 1420 420 mt

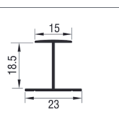

M50 2930 420 mt

Teknik Detay / Details

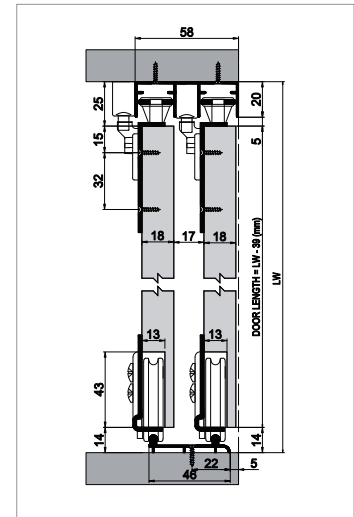

Kayar Kapak Sistemleri

Topline 1200 / İçte Duran Kapak Pozisyonu
Sliding Door System With Sof Case



Değişken yaşam alanları: TopLine sürgü kapak sistemi ile birinci sınıf mekan bölücüler oluşturabilirsiniz.



TopLine'in diğer bir uzmanlık alanı: Giyinme odaları



Sürgü kapak sistemi ahşap ve ahşap çerçeveli kapaklar için uygundur. Ağırlığına bağlı olarak, kapak alt kısmında kılavuz parça üzerinde veya bir kılavuz kanal üzerinde hareket eder.

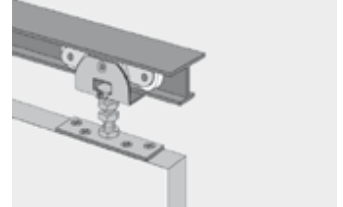

Bu stabil sistem kalınlığı 19 - 25,5 mm arasındaki kapakları taşır. Güvenli ve sessiz işleyiş.

Lüks bir dokunuş. TopLine 1200 / 1210 / 1230 sürgü kapak sistemi ile giyinme odası veya mekan bölücü sistemleri mükemmel bir şekilde oluşturabilirsiniz. Üstte çalışan bu sistemin işleyiş performansı otellerin yanı sıra yaşam alanlarında da kendini göstermektedir. 3 Farklı TopLine 1200 / 1210 / 1230 sürgü kapak sistemleri ile kapak ağırlığı 45 kg 'dan 125 kg 'a kadar uygulamaları gerçekleştirebilirsiniz.

Kapak malzemesi

Kapak ölçüleri ve ağırlığı

Kapak kanat sayısı ve kapak pozisyonu

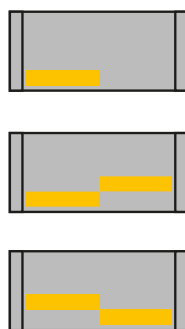
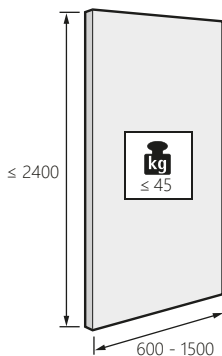
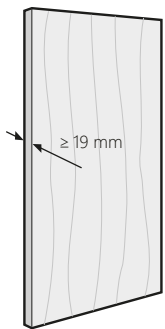

TEKNİK DETAYLAR / Details

- > İçte duran kapak pozisyonu
- > 1 Kanallı, üstte çalışan sürgü kapak sistemi
- > Ahşap kapaklar için
- > Kapak ağırlığı maks. 45 kg
- > Kapak yüksekliği maks. 1000 mm
- > Kapak kalınlığı min. 19 mm
- > Yükseklik ayarı +/- 9 mm
- > ANSI/BHMA Seviye 1 uyarınca test edilmiştir

Çalışma Prensibi

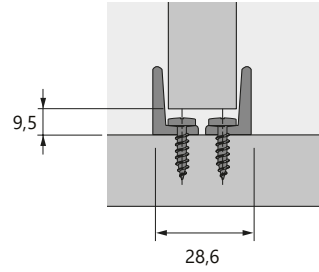
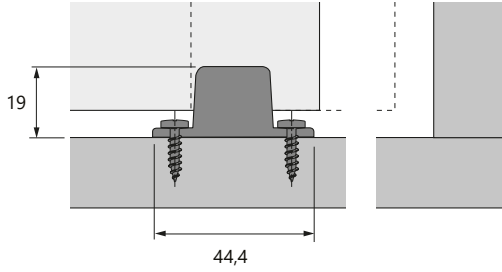
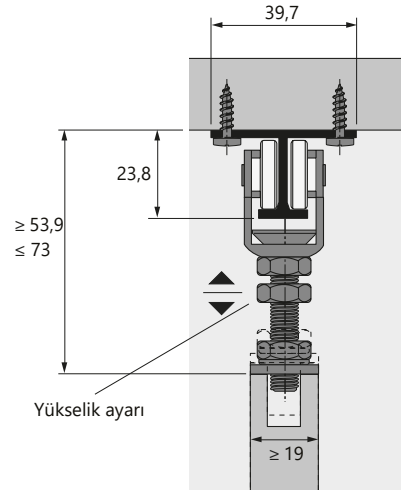
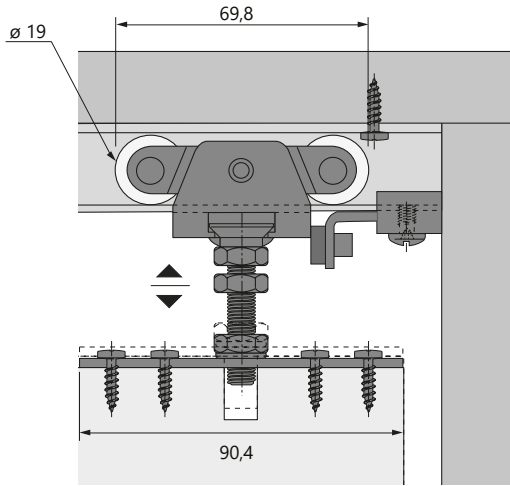

TopLine 1200 Mekanizma Seti



Kod/Code	Açıklama/Description
332762	TopLine 1200 0048293 Kapak Mekanizması 45 Kg

SET İÇERİĞİ

- > 2 Adet hareket mekanizması
- > 2 Adet sabitleme plakası
- > 2 Adet stoper
- > 2 Adet alt kılavuz
- > Montaj vidaları
- > Set 1 kapak için gerekli tüm parçaları içermektedir

UYARILAR

- > Profilleri lütfen ayrıca sipariş ediniz

Hareket Profili



Kod/Code	Açıklama/Description
332763	TopLine 1200 0048291 Üst Ray 3 mt

SET İÇERİĞİ

- > Delikli
- > Elokсалlı Alüminyum
- > Uzunluk 3000 mm

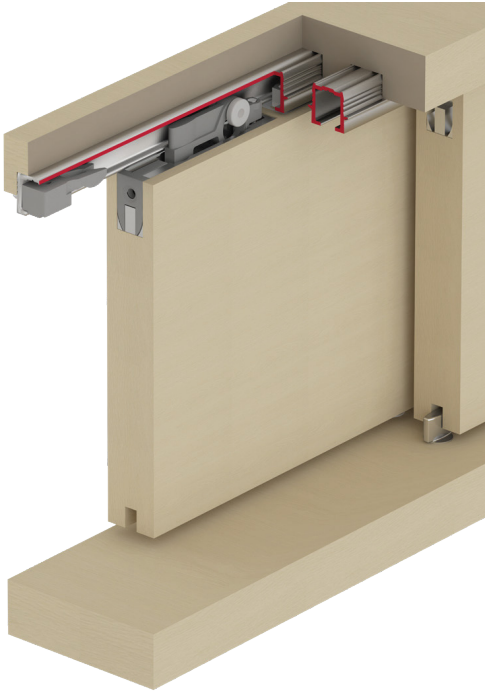

Ayarlı Sürme Kapak Sistemi

15 Kg 7600 PK Seri

Adjustable Sliding Door System For Ligth Doors (15 Kg)

Paket Kod	Açıklama/Description
ALB-7600-PK	2 Kapak için Ayarlı Sürme Kapak Sistemi 7600 PK
> Paket içeriğine 3m Ray Dahil Edilmiştir.	

TEKNİK DETAYLAR / Details
> 15 Kg Taşıma Kapasitesi
> 18 - 22 mm Kapak Kalınlıklarında Uygulama İmkânı
> Alüminyum Üst Ray
> Üst Ray Üzerinde Manuel Stoper
> Opsiyonel Yavaşlatıcı Sistem Kullanılabilmektedir
> Alt ve Üst Ray Paket İçeriğine Dahil Değildir.

Kod/Code	Açıklama/Description
073231	Ayarlı Sürme Kapak Sistemi 15 Kg 7600 PK
071365	Alüminyum Üst Ray 3m

Yavaşlatıcı Sistem

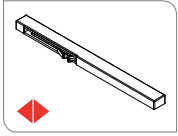

6960

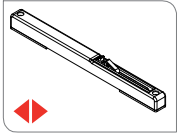

6940

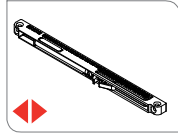

6941

Paket içeriği

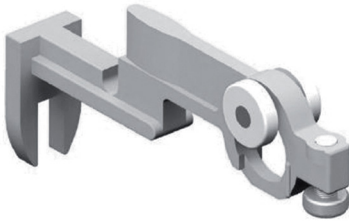

Üst Mekanizma

Takım
2 Adet



Üst Montaj Kabza

Takım
2 Adet



Alt Kılavuz

Takım
1 Adet



Ray Tutucu

Takım
2 Adet



Üst Stoper

Takım
2 Adet

Alüminyum Üst Ray 7610

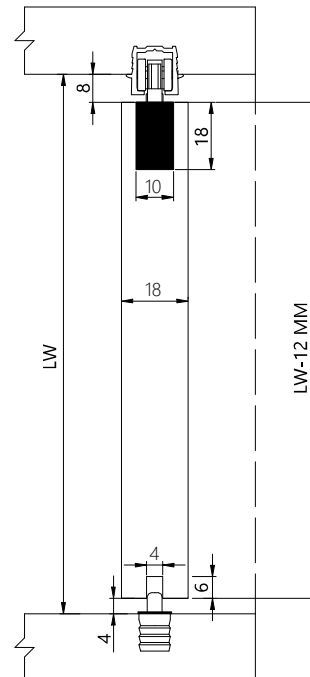
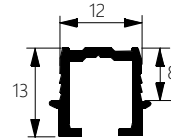



Ayarlı Cam Sürgü Sistemi

25 Kg 7700 Seri

Adjustable Sliding Glass Door System

Paket Kod	Açıklama/Description
ALB-İK-7700	Tek Kapak İçin İçte Kayan Sistem 7700
ALB-İK-7700-2	2 Kapak İçin İçte Kayan Sistem 7700
> Paket İçeriğine 3m Ray Dahil Edilmiştir.	

TEKNİK DETAYLAR / Details

- > 25 Kg Taşıma Kapasitesi
- > 1,5 m² 4 mm Cama Kadar Taşıma İmkanı
- > Alüminyum Üst Ray
- > Yükseklik Ayarlı Üst Makara Modülü
- > Alüminyum Alt ve Üst Cam Taşıyıcı Profil
- > Üst Ray Üzerinde Poliamid Stoplama Elemanı
- > Kapak Alt Bölüm Kullanım Detayında Profil Kapama veya Cam İçin İzleyici Kullanım Alternatifleri
- > Alt ve Üst Ray Paket İçeriğine Dahil Değildir.

Kod/Code	Açıklama/Description
316986	Ayarlı Cam Sürgü Sistemi 25 Kg 7700
059810	Ayarlı Cam Sürgü Sistemi Plus 25 Kg 7700
059811	Alüminyum Çiftli Üst Ray Cam İçin 3m 7715
059812	Alüminyum Alt Ray Cam İçin 3m 7710
059814	Alüminyum Çerçeve Kasa Cam İçin 3m 7705

M08 7700 1 Takım İçeriği - Kutuda 2 tk./ 1 Set Includes - 2 Set in a Box



M08 7700 PLUS 1 Takım İçeriği - Kutuda 2 tk./ 1 Set Includes - 2 Set in a Box



Ray Profilleri / Rail Profiles



Opsiyonel Aksesuar / Optional Accessories



Teknik Detay / Details

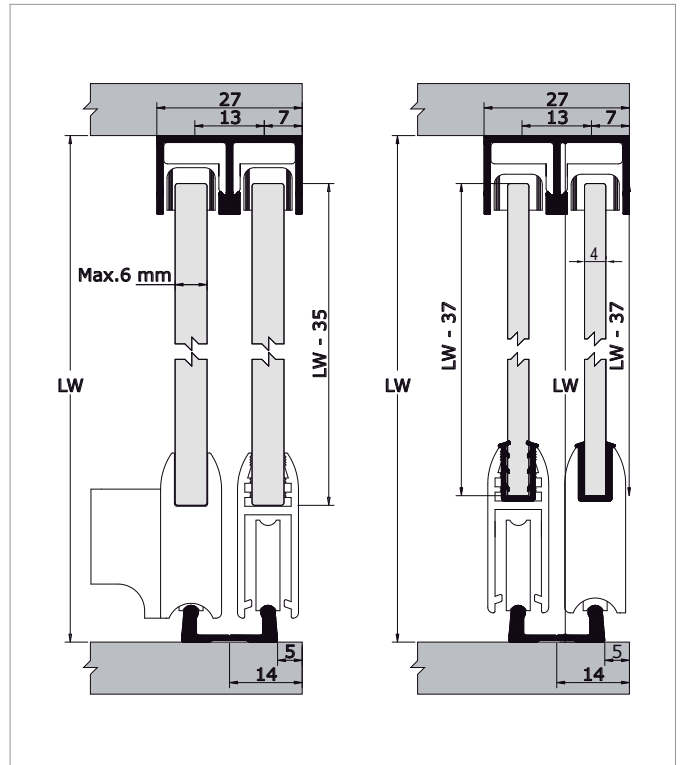



Hafif Sürme Kapak Sistemi

40 Kg 7040 Seri (Plastik Üst Kılavuz)
Sliding Door System For 40 Kg Doors

Paket Kod	Açıklama/Description
ALB-İK-7040	2 Kapak İçin İçte Kayan Sistem 7040
> Paket İçeriğine 3m Ray Dahil Edilmiştir.	

TEKNİK DETAYLAR / Details

- > Çelik Rulmanlı Poliamid Enjeksiyon Baskılı Teker Sistemi .
- > Galvaniz Kaplamalı Çelik Gövde
- > Alüminyum ve Pvc Alt ve Üst Ray Alternatifleri
- > Üst Ray Üzerinde Poliamid Stoplama Elemanı
- > **16 - 18 - 20 - 22 mm** Kapak Kalınlıklarında Uygulama İmkanı
- > PVC Alt ve Üst Ray Opsiyoneldir
- > Alt ve Üst Ray Paket İçeriğine Dahil Değildir.

Kod/Code	Açıklama/Description
059952	Hafif Sürme Kapak Mekanizması 40 Kg 7040
059953	Alüminyum Alt ve Üst Ray 3m 7041
063534	*PVC Alt ve Üst Ray 3m 7042

Yavaşlatıcı Sistem

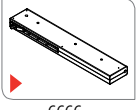

6666



Alt Makara 7040 501

Takım
2 Adet

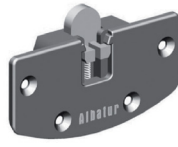

Üst Kılavuz 7040 502

Takım
2 Adet

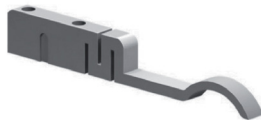

Alt ve Üst Stoper 7040 503

Takım
2 Adet

Alüminyum Alt ve Üst Ray
7041 410

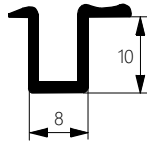
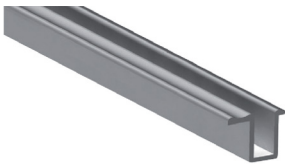

PVC Alt ve Üst Ray
7042

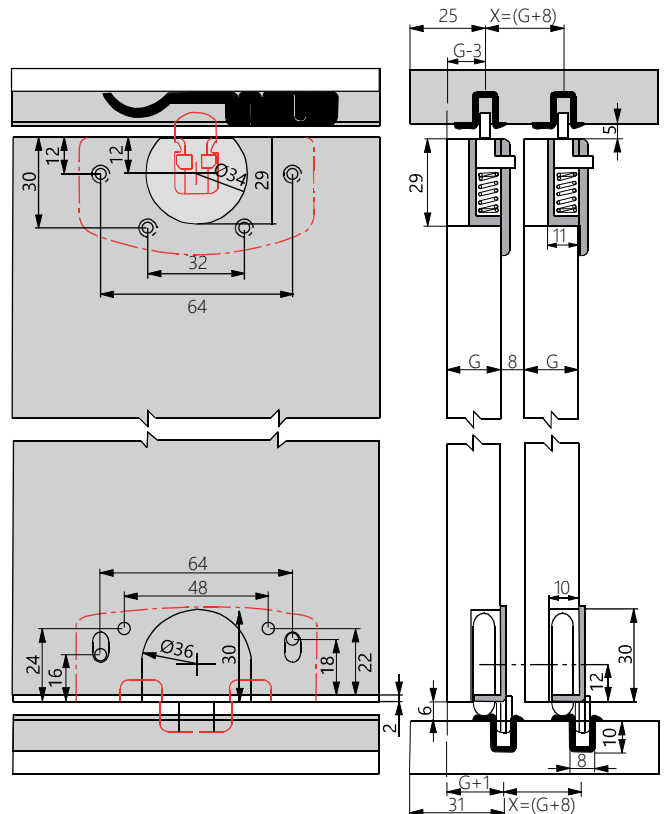
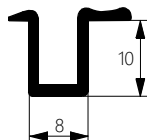
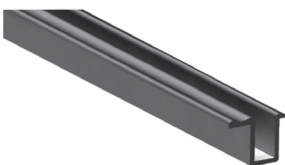



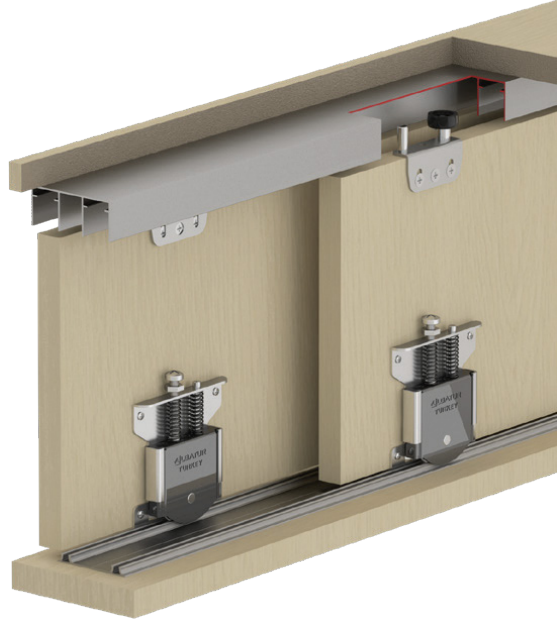

Sürme Sistem Ayarlı Pano Mekanizması
75 Kg 7030 SFT
Adjustable Sliding Door System

Paket Kod	Açıklama/Description
ALB-İK-7030	Tek Kapak İçin İçte Kayan Sistem 7030
ALB-İK-7030-2	2 Kapak İçin İçte Kayan Sistem 7030
> Paket İçeriğine 3m Ray Dahil Edilmiştir.	

TEKNİK DETAYLAR / Details

- > Çelik Rulmanlı Poliamid Enjeksiyon Baskılı Teker Sistemi
- > Galvaniz - Elektrostatik Boyalı Çelik Gövde
- > Yükseklik Ayarlı Alt Makara Modülü
- > Alüminyum Alt ve Üst Ray
- > Alt ve Üst Ray Üzerinde Poliamid Stoplama Elemanı
- > **16 -18 -20 -22 -30 mm** Kapak Kalınlıklarında Uygulama İmkanı
- > Alt ve Üst Ray Paket İçeriğine Dahil Değildir.

Kod/Code	Açıklama/Description
062861	Sürme Sistem Ayarlı Pano Mekanizması 7030
071418	Alüminyum Alt Ray 3m 7103
071418	Alüminyum Alt ve Üst Ray 3m 7102
072251	Alüminyum Alt ve Üst Ray 3m 7108
071294	Alüminyum Alt ve Üst Ray 3m 7107
062865	Stoper ST 7031 (Opsiyonel)

■ M03 7030 SFT 1 Takım İçeriği / 1 Set Includes

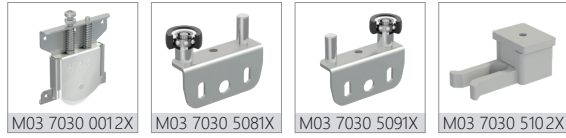

■ Ray Profilleri / Profiles

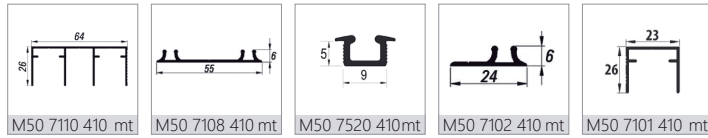

■ Kulp Profilleri / Handle Profiles

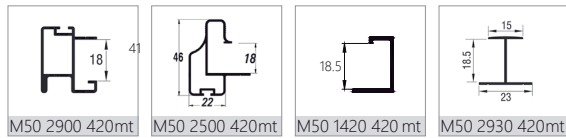

■ Opsiyonel Aksesuar / Optional Accessories



■ Teknik Detay / Details

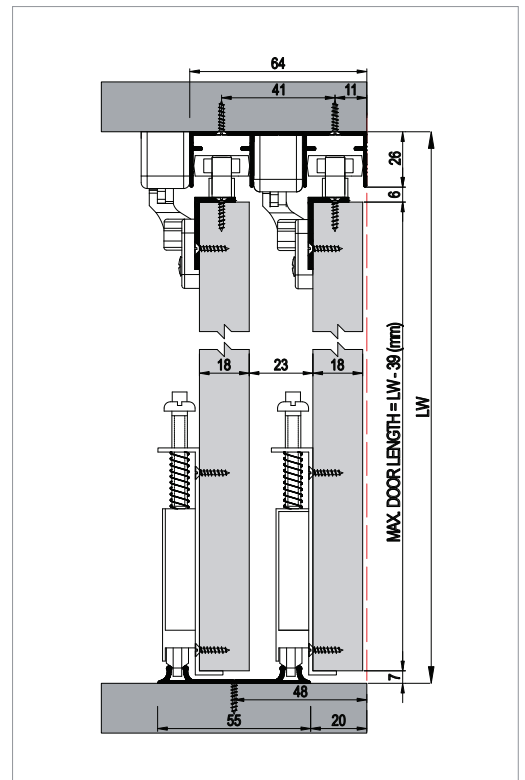

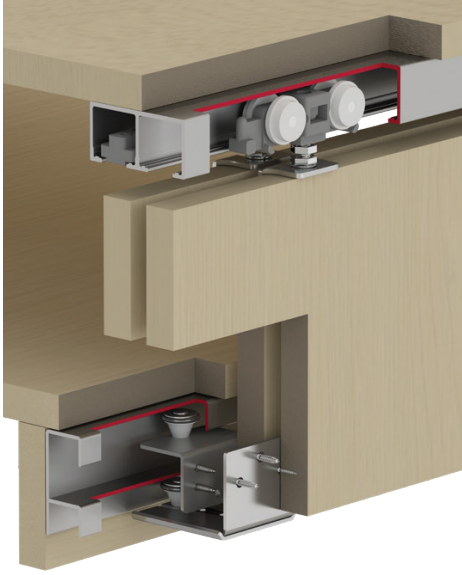

Ayarlı Sürme Gardrop Sistem

60 Kg 7320 Seri

Adjustable Sliding Door System

Paket Kod	Açıklama/Description
ALB-KK-7320-2	2 Kapak İçin Karma Kayan Gardrop Sistemi 7320
> Paket İçeriğine 3m Ray Dahil Edilmiştir.	

TEKNİK DETAYLAR / Details

- > Yüksek Ayarlı Üst Makara Modülü
- > Alüminyum Alt ve Üst Ray
- > Üst Ray Üzerinde Stoplama Elemanı
- > Alt ve Üst Ray Paket İçeriğine Dahil Değildir.

Kod/Code	Açıklama/Description
060955	Ayarlı Sürme Gardrop Sistemi İç Kapak 60 Kg 7320
060956	Ayarlı Sürme Gardrop Sistemi Dış Kapak
060958	Alüminyum Üst Ray 3 m 7222
060957	Alüminyum Alt Ray 3m 7242



M02 7320 İç Kapak 1 Takım İçeriği / Internal Door 1 Set Includes

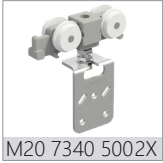

M02 7322 Dış Kapak 1 Takım İçeriği / External Door 1 Set Includes

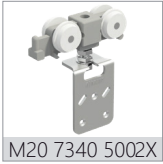

Ray Profilleri / Profiles

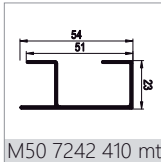
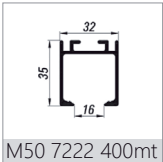

Kulp Profilleri / Handle Profiles

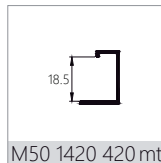
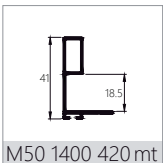

Teknik Detay / Details

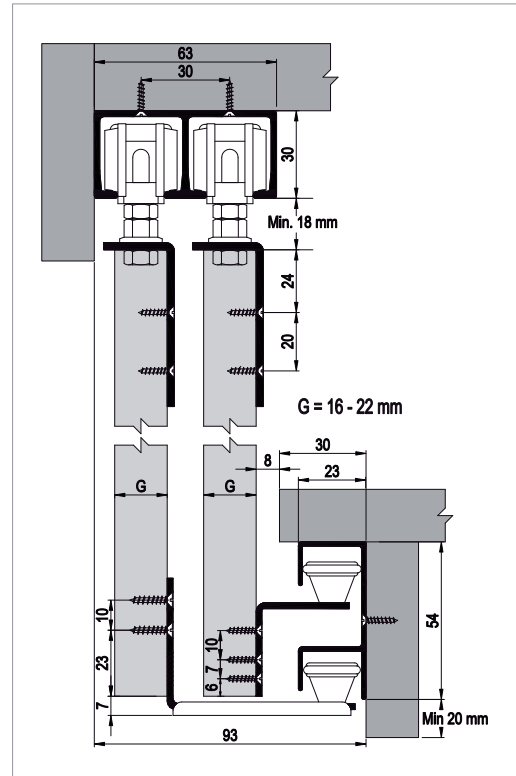



Hawa SWISS

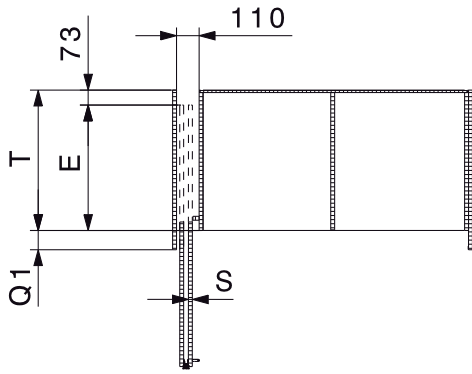
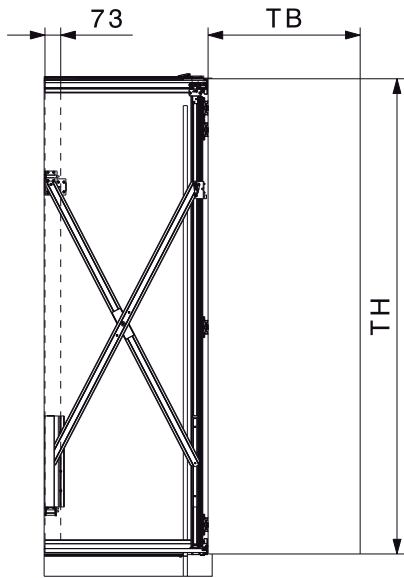

$$T = TB + 73 \text{ mm} - Q1$$

$$E = T - 73 \text{ mm}$$

$$Q1 = 75 \text{ mm} + S$$

Hawa Folding Concepta 25 Kapak Sistemi Wooden Sliding Door System

Kod/Code	Açıklama/Description
267620	Hawa 24735 Folding Concepta 25 1250-1850mm Sol
267619	Hawa 24736 Folding Concepta 25 1250-1850mm Sağ
130501	Hawa 24737 Folding Concepta 25 1850-2600mm Sol
131497	Hawa 24738 Folding Concepta 25 1850-2600mm Sağ

TEKNİK DETAYLAR / Details

- > Uygulaması kolay, kullanımı pratik ahşap ve cam pivot açılır ve içeri sürülür
- > Dolap kapakları ve bölme kapılar için **25kg** taşıma kapasiteli donanım
- > Folding Concepta kapıları Oda yüksekliğindeki kapılarda boydan boy kullanabilirsiniz.
- > Üstün özelliği sayesinde Kapılarda hiçbir şekilde sarkma olmaz.
- > Uygulaması kolay ve verimlidir.
- > Mükemmel tasarlanmış bu sistem size iki farklı montaj şekli sunar.
- > Kapıları tek el ile kolaylıkla kullanabilirsiniz.
- > Özellikler:
 - Max. **25kg** kapılar içindir.
 - Kapı genişliği: 300-700mm
 - Kapı Yüksekliği: 1250-2600mm
 - Kapı Kalınlığı: 19-28mm

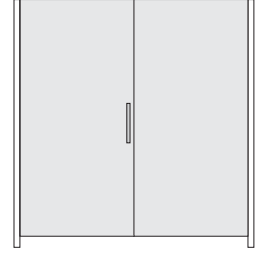
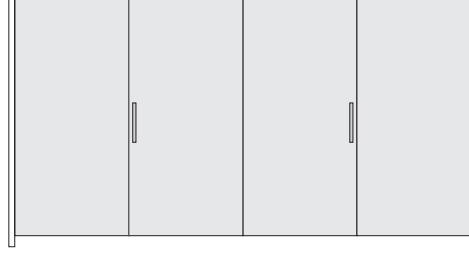
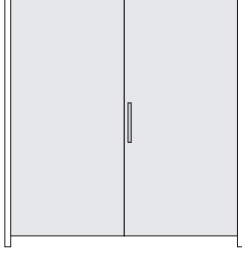

Sol taraf montaj uygulama

İkili montaj uygulaması

Sağ taraf montaj uygulama

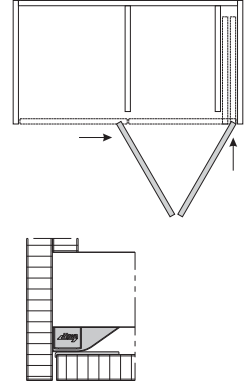
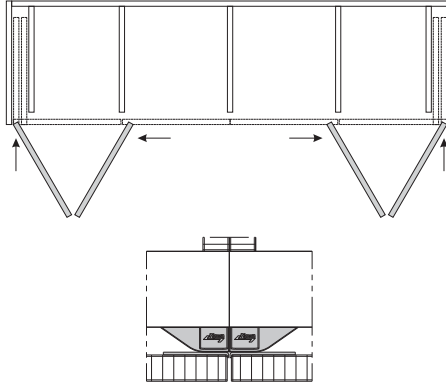
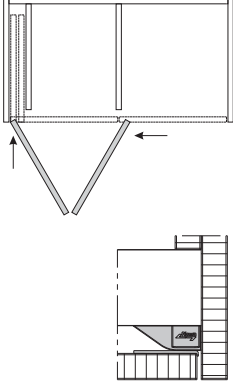

Alt profil ve kapağı aynı hizada konumlandırma aparatı

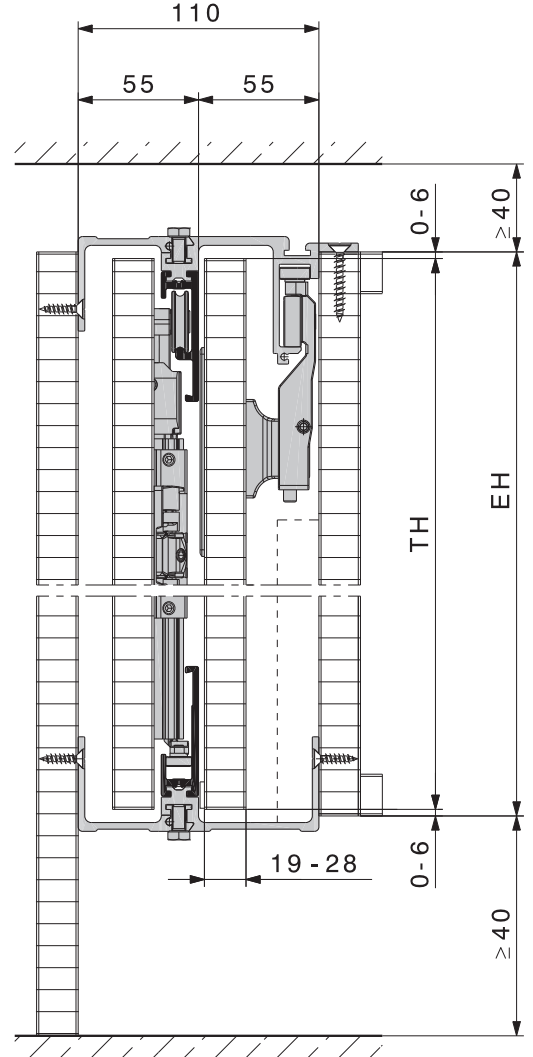
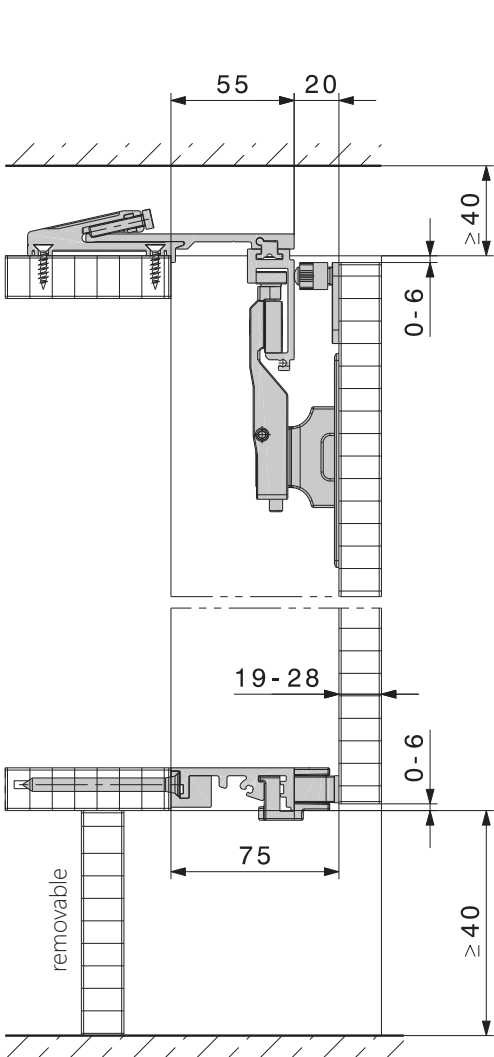



- > Kapak Ağırlığı : 25 / 30 / 40 / 50 kg
- > Kapak Yüksekliği : 1250 - 2850 mm
- > Kapak Genişliği : 300 - 900 mm
- > Kapak Kalınlığı : 19 - 50 mm
- > Kapak Ayarı : Ön Taraftan
- > Kapak Yönü : Sağ veya Sol Kullanılabilir

Ahşap / Wooden	T	TH	E
HAWA-Concepta 25	≤650 mm	1250-1850 mm	≤577 mm
HAWA-Concepta 30	≤900 mm	1851-2300 mm	≤877 mm
HAWA-Concepta 40	≤900 mm	1851-2500 mm	≤877 mm
HAWA-Concepta 50	≤900 mm	1900-2850 mm	≤877 mm

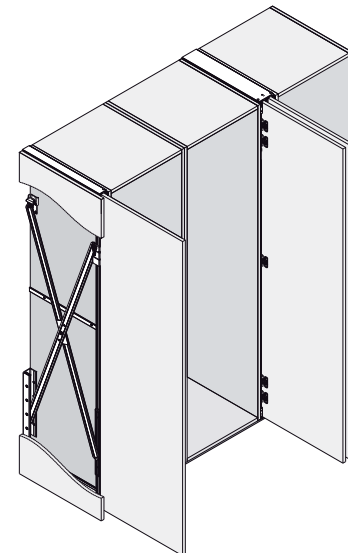
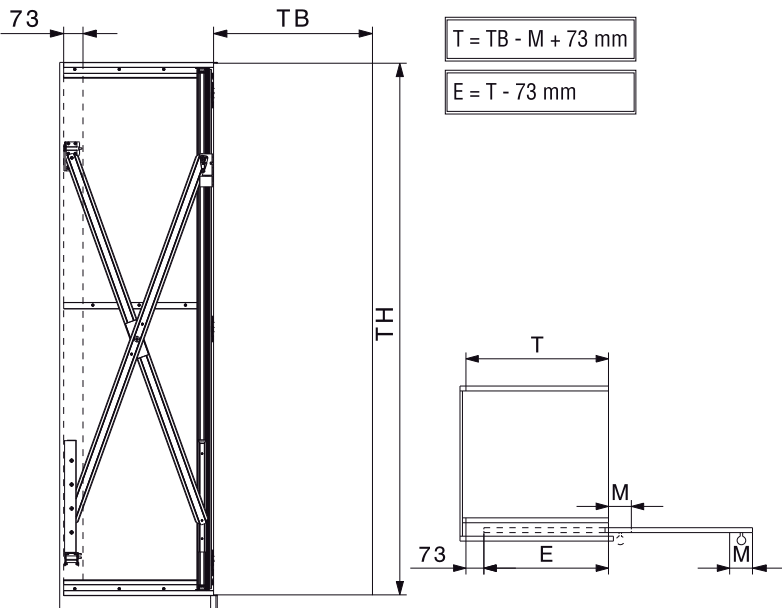

Hawa Concepta Kapak Sistemi

Wooden Sliding Door Systems

HAWA-Concepta 25

Kod/Code	Açıklama/Description
314499	Concepta 1250 - 1850mm Set Ahşap
Kapak Yüksekliği :1250-1850mm	Kapak Genişliği : 300-900mm
Kapak Kalınlığı :19-50mm	Kapak Ağırlığı : Max. 25kg

HAWA-Concepta 30

Kod/Code	Açıklama/Description
131499	Concepta 1851 - 2300mm Set Ahşap
Kapak Yüksekliği :1850-2300mm	Kapak Genişliği : 300-900mm
Kapak Kalınlığı :19-50mm	Kapak Ağırlığı : Max. 30kg

HAWA-Concepta 40

Kod/Code	Açıklama/Description
191053	Concepta 1851 - 2500mm Set Ahşap
Kapak Yüksekliği :1850-2500mm	Kapak Genişliği : 300-900mm
Kapak Kalınlığı :19-50mm	Kapak Ağırlığı : Max. 40kg

HAWA-Concepta 50

Kod/Code	Açıklama/Description
298723	Concepta 2301 - 2850mm Set Ahşap
Kapak Yüksekliği :2301-2850mm	Kapak Genişliği : 300-900mm
Kapak Kalınlığı :19-50mm	Kapak Ağırlığı : Max. 50kg

TEKNİK DETAYLAR / Details

Uygulaması kolay, kullanımı pratik ahşap pivot açılır ve içeri sürülür. Dolap kapakları ve bölme kapılar için 25 / 30 / 40/ 50 kg taşıma kapasiteli donanım Concepta kapıları, gövde yanları boyunca veya duvar boşluklarına sürülebilir, böylece herhangi bir çıkıntı içermeyen yüksek kapak tasarımları mekan bölümlendirmeleri ahşap olarak rahat ve sorunsuzca elde edilebilir.

Özellikler

- Mobilya ve mekan bölümlendirmeleri ahşap kapak açılır sürülür
- Emsalsiz makas teknolojisi geniş ve ağır kapaklar için yeterlidir.
- Modüler cam sistemi için 4 farklı dizayn alternatifidir.
- Ayarlar önden yapılır,
- Bütün parçalar ana panele bağlanmaktadır,
- Herhangi bir gövdeye ihtiyaç duyulmaksızın kanatlar duvara gizlenebilir.
- Aynı set sağ ve sol olarak kullanılabilir.



Katlanır Kapak Sistemi Wing Line 770

2 Kanatlı 1 Katlanır Kapak İçin
Sistem Parçaları (20 Kg)
Folding Door System

Paket Kod	Açıklama/Description
HT-056778	2 Kanatlı 1 Katlanır Kapak Seti Sol Wing Line 770
HT-056928	2 Kanatlı 1 Katlanır Kapak Seti Sağ Wing Line 770

> Paket İçeriğine 2m Ray Dahil Edilmiştir.

TEKNİK DETAYLAR / Details

- > Çift kanatlı katlanır kapaklar için
- > Mevcut kapak pozisyonu
- > Ahşap kapaklar için
- > Hafif sensys menteşeler ile birlikte kullanılabilir
- > 20 kg'ye kadar kapak kanadı ağırlıkları
- > 2200 mm'ye kadar kapak yükseklikleri
- > 500 mm'ye kadar kapak kanadı genişlikleri
- > Wingline 26 ile alt ray olarak
- > 40000 Döngü test edilmiştir

Kapak ölçüleri ve pozisyonu

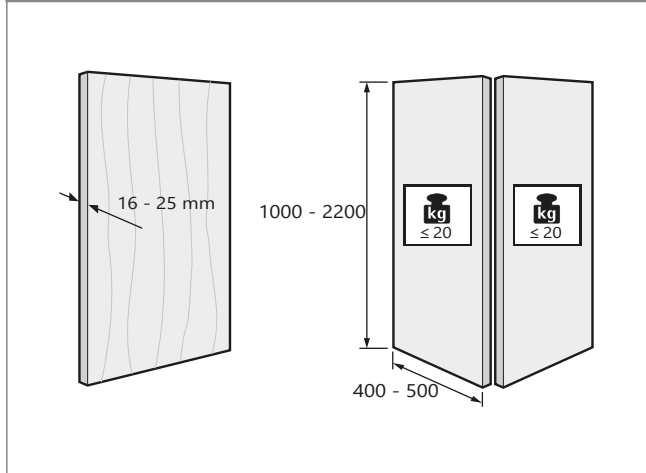

Kapak kanadı sayısı ve kapak pozisyonu

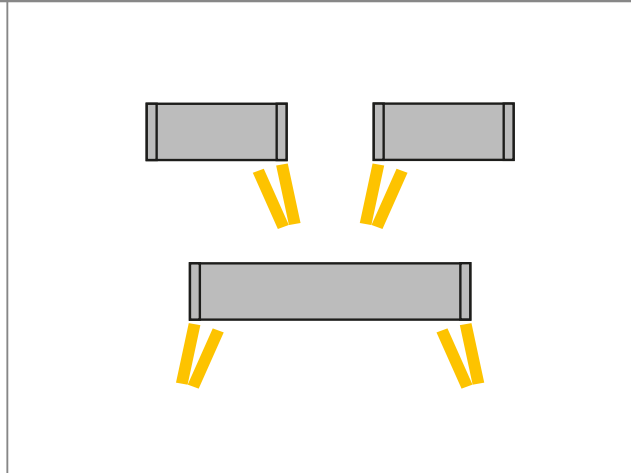

Katlanır Kapak Sistemi Wing Line 770

2 Kanatlı 1 Katlanır Kapak İçin Sistem Parçaları (20 Kg)

Folding Door System

WingLine 770 montaj ölçüleri

2 kanatlı kapak paketi

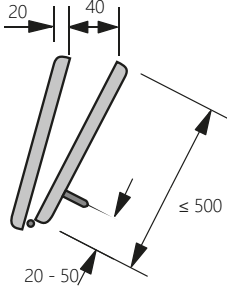

2 kanatlı katlanır kapak

Kapak genişliği maks. 1000 mm

Kapak ağırlığı / kanat maks. 20 kg

Kapak kanat yüksekliği maks. 2200 mm

2 kanatlı katlanır kapak

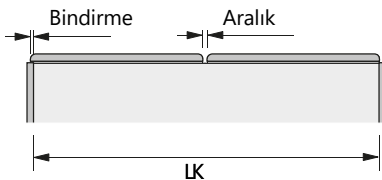
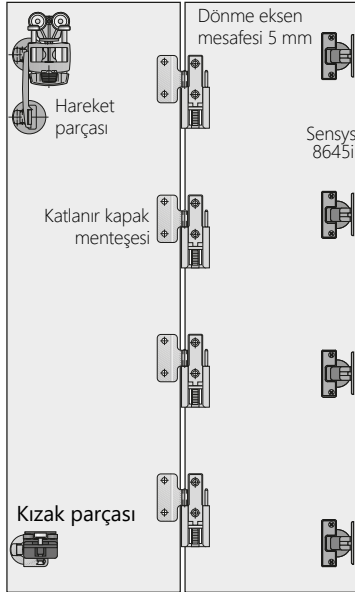

* B Delik aralığı mm	13,5 14 14,5 15 15,5
Aralık mm	5 4 3 2 1

Kapak kanat kontürleri ve aralıkları (parmak koruması olarak)

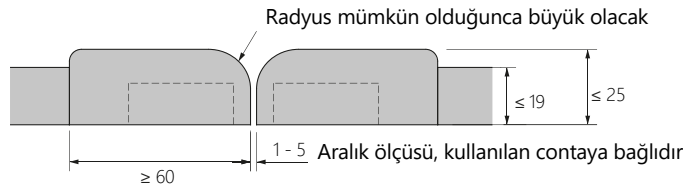
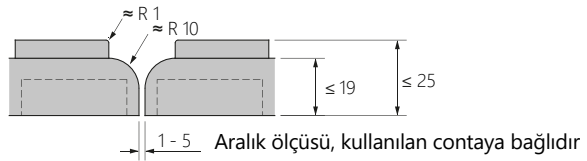
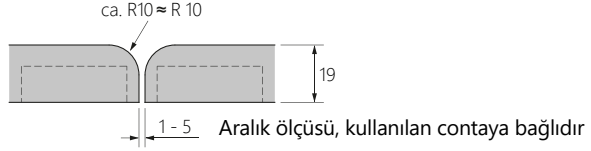

Delik şablonları

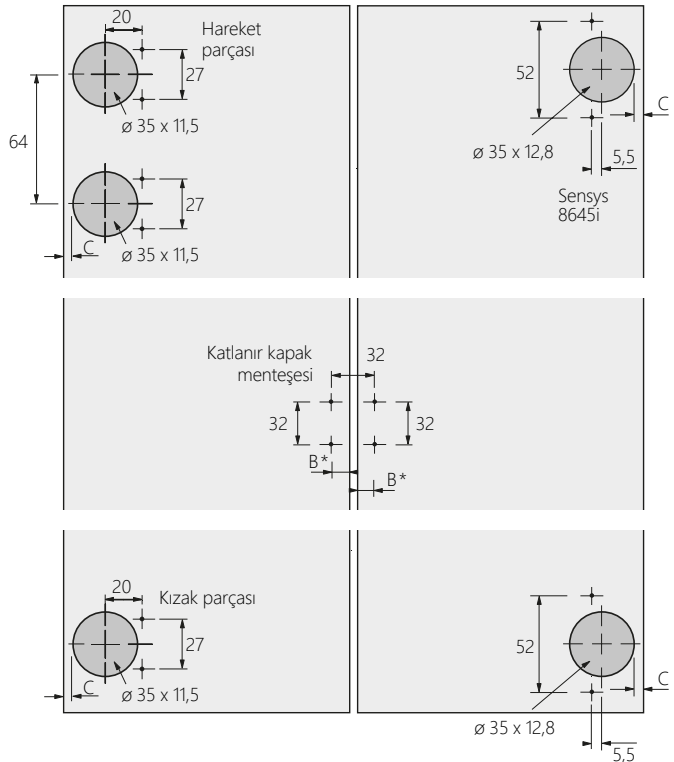

Kapak genişliği / kapak kanadı hesaplaması
 Kapak genişliği = İçten içe gövde ölçüsü + (2 x bindirme*)
 Kapak kanat genişliği = (İçten içe gövde ölçüsü - 1 x aralık + 2 x bindirme*) ÷ 2
 * Bindirme: maks. 15 mm, C ölçüsü 5 mm

Menteşeler / montaj plakaları ayrı sipariş edilecektir - bakın Tas menteşeler

Çalışma Prensibi

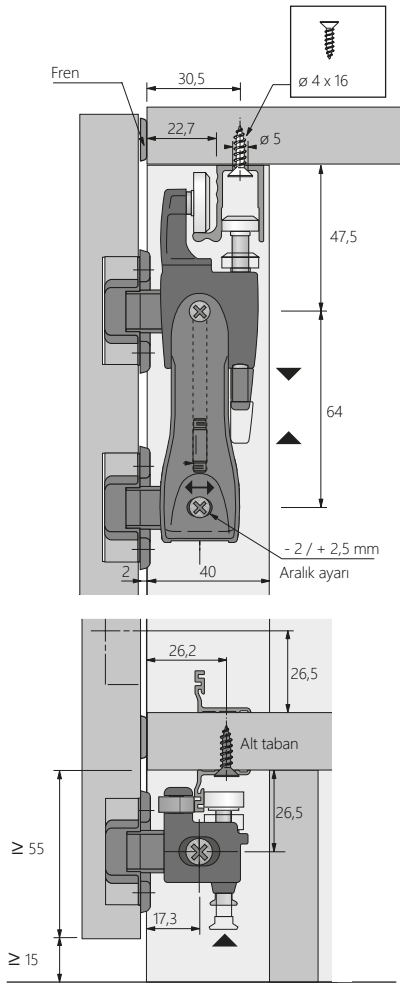

WingLine 770 Seti



Montaj yönü

sol
sağ

Kilit



Montaj yönü

sol
sağ

Kilit İçin Kapatma Başlığı



► Plastik, gri

Klavuz Parça



Montaj yönü

sol
sağ

Katlanır Kapak Menteşesi



- Hızlı montaj için
- Vidalama için
- Plastik, gri (1), nikelajlı çelik (2)

Katlanır kapak menteşeleri için delme şablonu



- 2 ve 5 mm'lik bağlantı ayarlarında
- Plastik

Ray Profili



- Vidalama için
- Uzunluk: 2 000 mm
- Parlak Alüminyum

Öneriler:

- Talep üzerine müşteriye özel uzunluklarda

mm cinsinden uzunluk	Sipariş No.	AB
2000	1 079 089	1/4 Ad.
özel	LA 2070	100 Ad.

Klavuz Profili



- Vidalama için, vida yerleri önceden delinmiş
- Uzunluk: 2 000 mm
- Gümüş eloksallı Alüminyum

Öneriler:

- Talep üzerine müşteriye özel uzunluklarda

mm cinsinden uzunluk	Sipariş No.	AB
2000	0 072 919	1/4 Ad.
özel	LA 2130	100 Ad.

Katlanır Kapak Sistemi Wing Line 770 Alüminyum

Geniřliđi 19 mm'lik Alüminyum Çerçeve
Profil için Fonksiyon / Montaj

2 Kanatlı Kapak Paketi

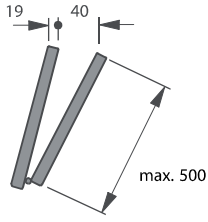

> 2 Kanatlı Katlanır Kapak
Kapak Geniřliđi Max.1000 mm,
Kapak Ađırlıđı/Kanat Max. 20 Kg
Kapak Kanat Yüksekliđi Max. 2200 mm

Kapak Kanat Kontürleri ve Yarıkları

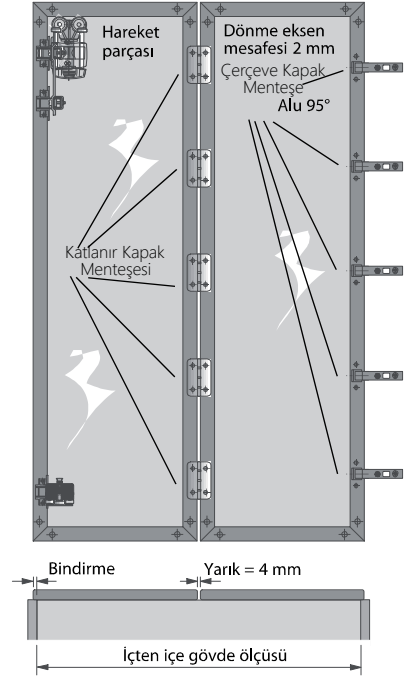
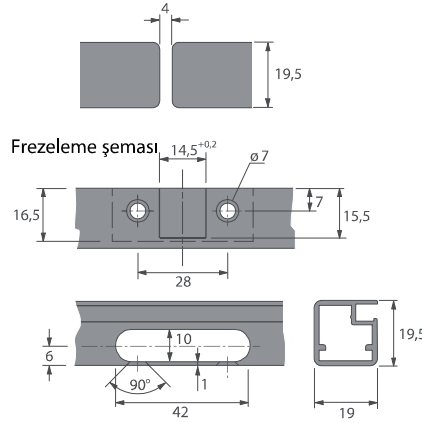

Kapak Geniřliđi/Kapak Kanadı Hesaplaması

Kapak Geniřliđi = İçten İçe Gövde Ölçüsü + (2 x Bindirme*)

Kapak Kanat Geniřliđi = İçten İçe Gövde Ölçüsü - (1 x Yarık) + (2 x Bindirme*) : 2 -

*Bindirme : Max. 15 mm, C Ölçüsü 5 mm

Delik Şablonları :

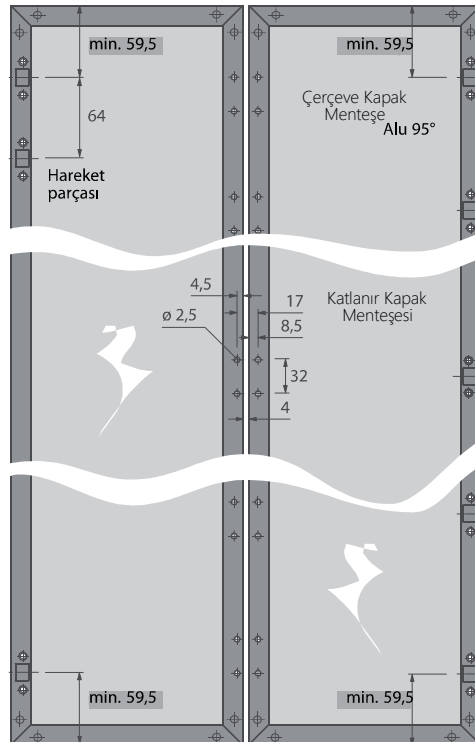

Cam Ölçüsü=Kapak Geniřliđi/Yüksekliđi-26 mm

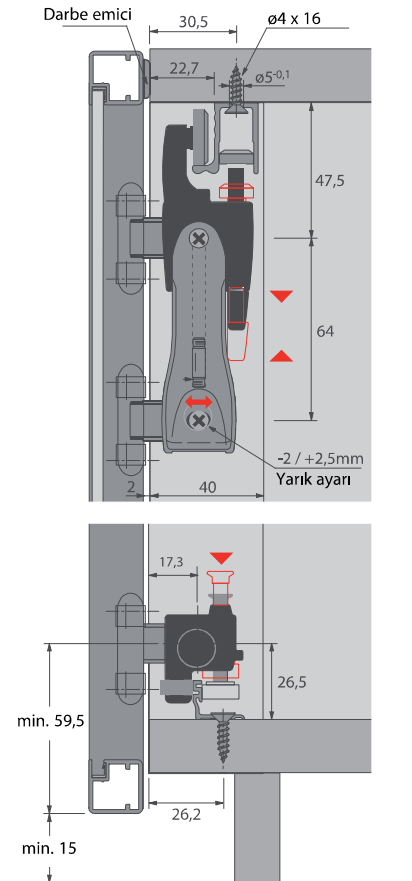



40

Kayar Katlanır Kapak Sistemleri
2 Kapaklı Katlanır Kapak Sistemleri (40 Kg)
Sliding Folding Door System With Soft Closing

Kod/Code	Açıklama/Description
ALB-7010 SFT	2 kapaklı 22 mm Yavaşlatıcı Paket Sistem
066302	Alüminyum Üst Ray 3 mt
066303	Alüminyum Alt Ray 3 mt
058610	Alüminyum Mat Kenar Kulbu 3 mt

TEKNİK DETAYLAR / Details

- > Tek Kapak İçin Max. Taşıma Kapasitesi
- > Kapak Yüksekliği Max. 2400 mm
- > Kapak Genişliği Max. 600 mm
- > 2000 mm Üzeri Kapaklarda İlave Mentеше Kullanılmalıdır
- > 18 mm Kapak Kalınlıkları İçindir

M05 7440 1 Takım İçeriği / 1 Set Includes



M05 7440 5001X



M05 7423 2X



M05 7400 5021X

Ray Profilleri / Rail Profiles



M50 7445 410 mt

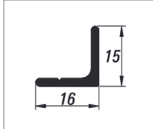

M50 7460 410 mt

Teknik Detay / Details

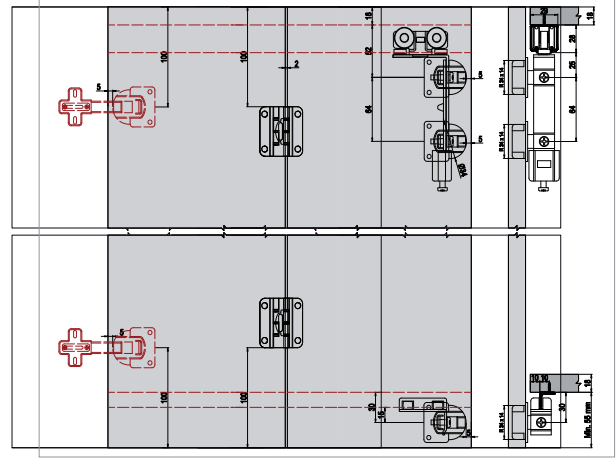



Metal Çek-Ger Mekanizması
Çek-Ger
Metal Door Straightener

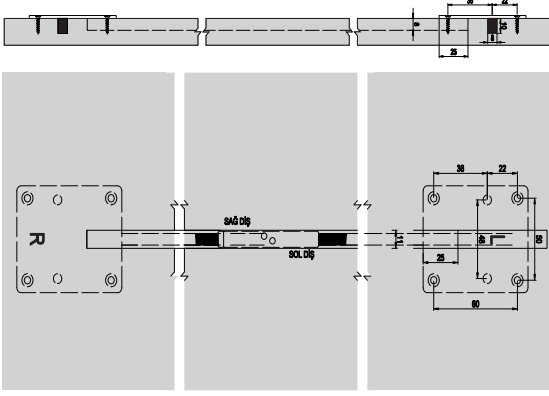

Kod/Code	Açıklama/Description
072273	Metal Çek-Ger Mekanizması CG 01

TEKNİK DETAYLAR / Details

> Metal başlı Çek-Ger mekanizması



! Neden Çek-Ger Kullanmalı

Hava şartları, rutubet, taşıma ve istifleme (depolama) nedeniyle mdf, suntalam ve ahşap kapak malzemelerde kalıcı burkulma ve atıklık oluşabilmektedir. Ayrıca ahşap üzerine eklenen cam, ayna ve diğer aksesuarlar kapağın düzlemselliğine etken faktörlerdir. Kapaklarımızda bu atıklığı gergi sistemleri ve yan duvarlarda kullanacağımız alüminyum dikme kulplar (dik düzlemde ahşabın düzlemselliğini sağlayabilecek kesit ve atık oluşabilecek eksende ahşabın mukavemetinden daha etkin dirençli alüminyum yada metal ekstrüde profil ve aksesuarlar) ile çözmek mümkündür. Lakin dikme kulplar ile çözüm üretim esnasında etkin olmasına karşın, depolama şartlarına bağlı olarak 1 yada 2 ay sonra açılan ambalajlı ürünlerde yetersi kaldığı görülmektedir. Bu tip ürün gruplarında çekger mekanizmaları kapaktaki atıklıkları, kullanıldıkları eksen yönünde çözüme kavuşturmaktadır. En ölçüsü 40cm e kadar olan kapaklarda merkezden bir adet, daha büyük en ölçülerinde iki adet çekger kullanımı önerilmektedir.

Cam ve ayna yapıştırılan kapaklarda çekger kullanımında dikkat edilmesi gereken bazı hususlar: Cam ayna vs grubu ahşap panele yapıştırılırken ahşap panel kesinlikle çok hassas ve düze bir zeminde tutulmalıdır. Aksi takdirde yapıştırılma anında tüm atıklıklar daha sonra çekger gergi yada kulp marifeti ile düzeltilmez bir durum oluşturmaktadır.

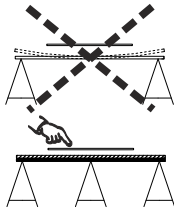

- Cam, ayna v.s. grubu ahşap panele yapıştırılırken, panel kesinlikle çok hassas ve düz bir zeminde tutulmalıdır. Aksi takdirde yapıştırılma anındaki tüm atıklık, daha sonra çekger gergi yada kulp marifeti ile düzeltilemez bir durum oluşturur.

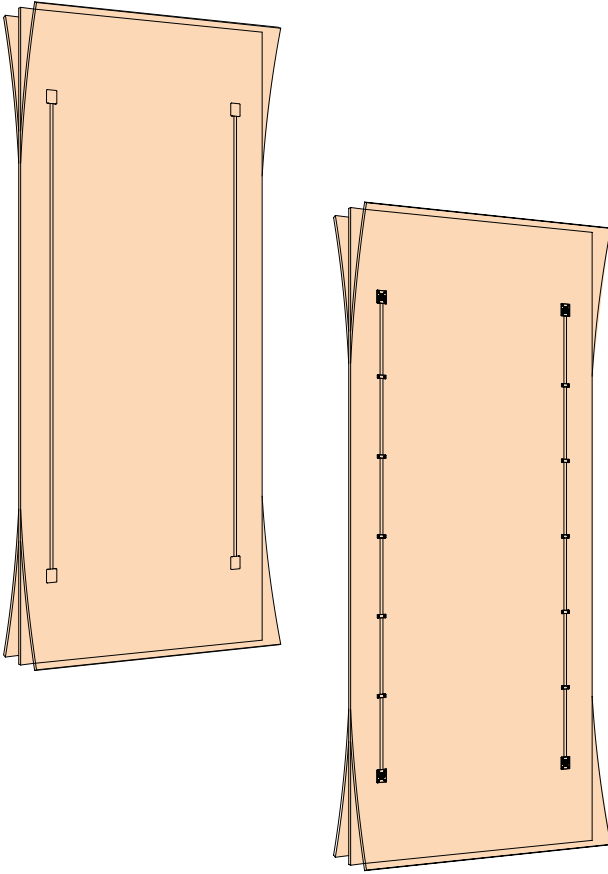

EKU Alüminyum Çek-Ger Mekanizması
Çek-Ger
Metal Door Straightener

Kod/Code	Açıklama/Description
332754	Hawa-EKU 056.3027.084 Alm. Çek-Ger Mekanizması
332758	Hawa-EKU 056.3027.081 Alm. Çek-Ger Mekanizması

TEKNİK DETAYLAR / Details

- > Metal başlı Çek-Ger mekanizması
- > 2000 mm ~ 2600 mm Yüksekliğindeki Kapakları Sabitlemek İçin Kapı Doğrultma Profili
- > Daha Kısa Kapılar İçin Kesilerek Ayarlanabilir.

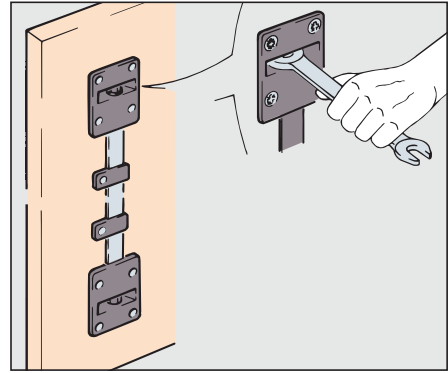

■ Teknik Detay / Technical Detail

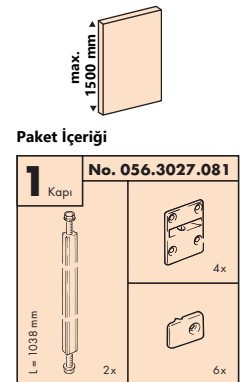
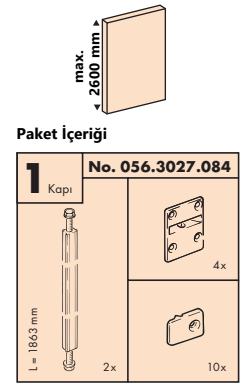
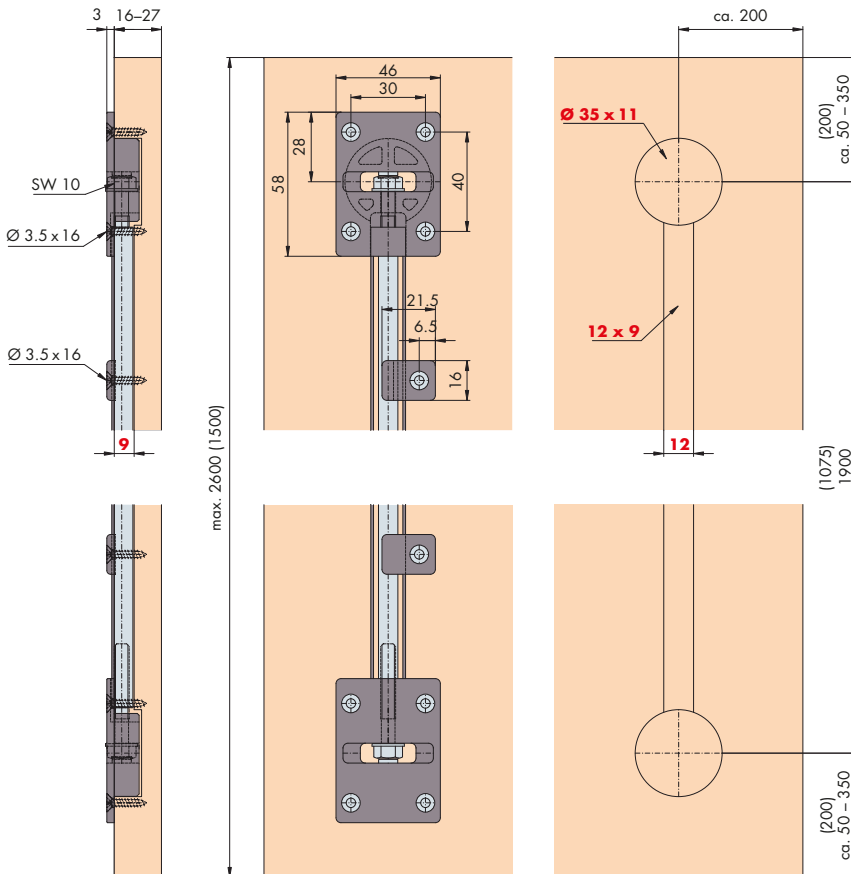

Kırmızı renkli ölçüler mekanizmanın kapıya uygulama şeklidir