

Kapı Kolları

Door Handles

14

"İyi Fikirler, İyi Çözümler..."



**PULL
PUSH**
**YENİ
TREND**



Gri
Grey



Ürün Kodu: 332915

Siyah
Black



332916

TEKNİK DETAYLAR / Details

> Basıncılı Zamak Metal Malzeme

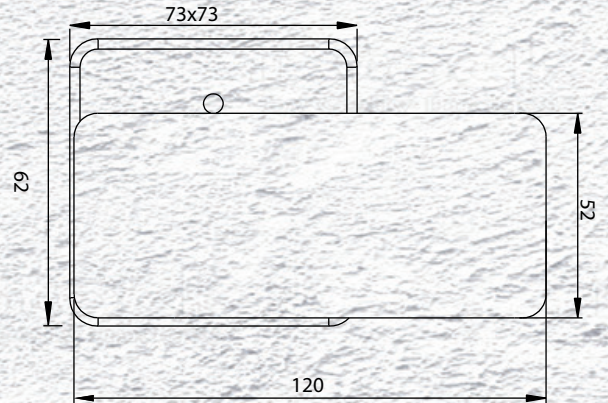

**PULL
PUSH**

**YENİ
TREND**

**SAĞLIKLI
TEK
DOKUNUŞ**



**“Temassız Kapı
Kolu Sayesinde,
Artık Kapıları El Ile
Temas Etmeden
Açma Ve Kapama
Yapabilirsiniz”**





Gri
Grey



Siyah
Black



Ürün Kodu: 333106

332916

TEKNİK DETAYLAR / Details

> Basıncılı Zamak Metal Malzeme

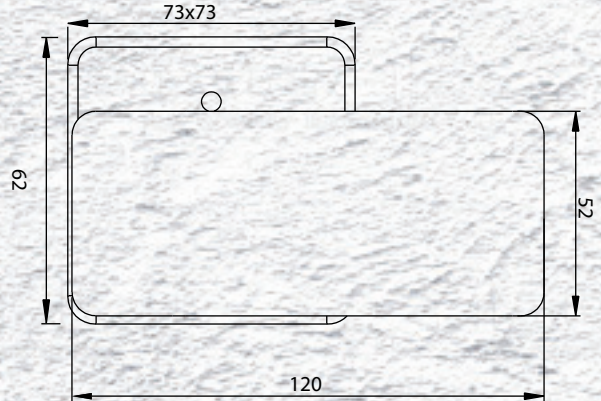

**PULL
PUSH**

**YENİ
TREND**

**SAĞLIKLI
TEK
DOKUNUŞ**



**Sessiz
Ve
Güvenilir**

**“Kolay ve Güvenirli
Olması, Bütün
Mekarlarda Kullanım
Olanagı Sağlarken Özel
İhtiyaç Sahipleri
Olan Kisilerde
Rahatlık Sağlar
Çocuklar için
uygun ve kullanılabilir ”**

Best Protections For Kids



No hurts ,



No worries :)



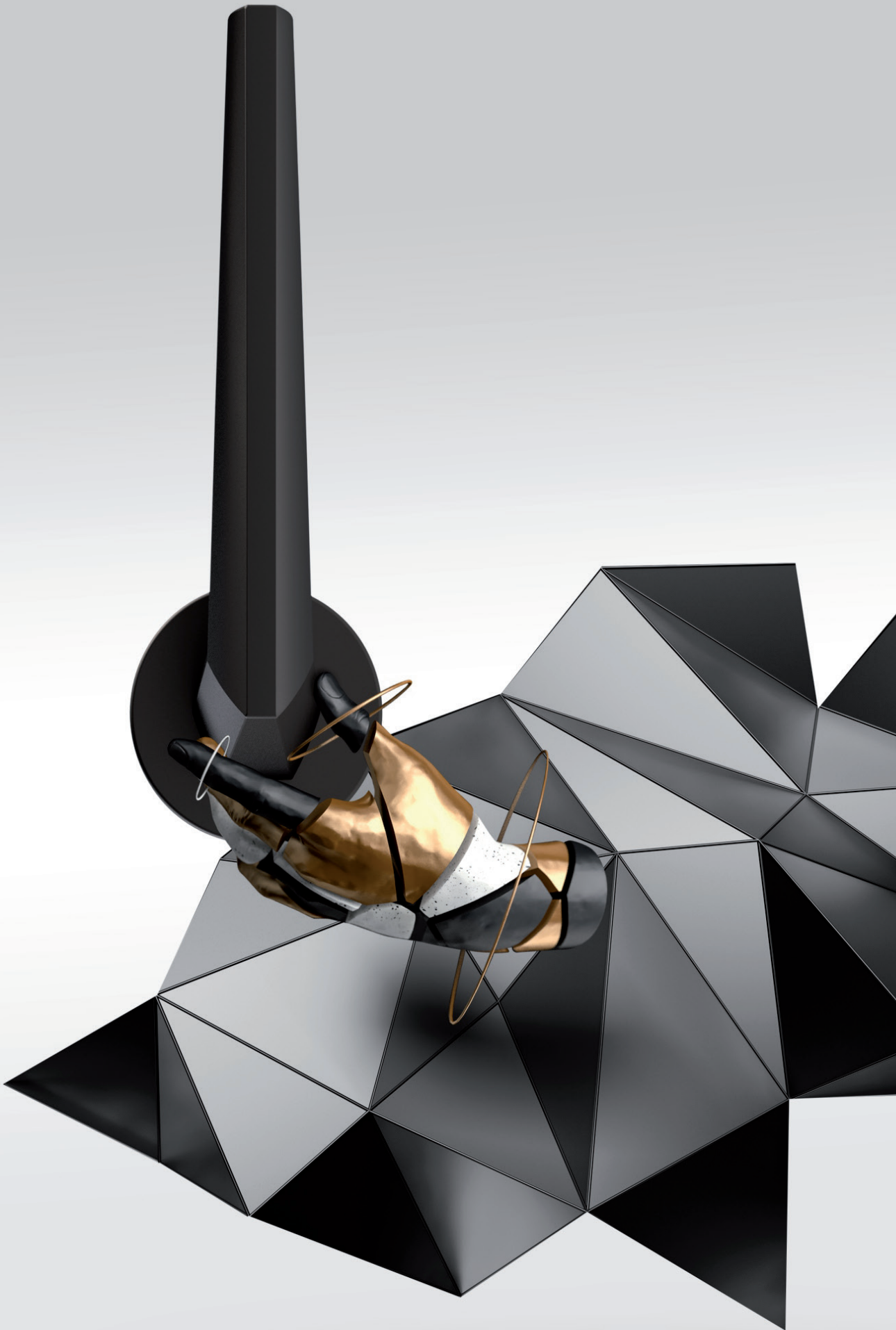

Azura Serisi

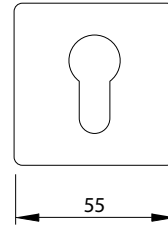
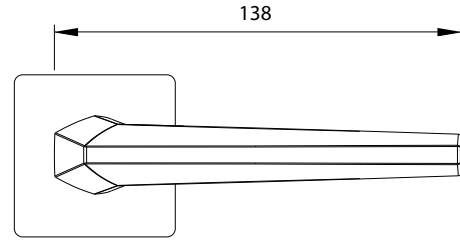

Krom
Chrome



Saten
Satin



Altın
Brass



Siyah
Black



Oda

328542

328536

328545

328539

Yale

328543

328537

328546

328540

W.C.

328544

328538

328547

328541

TEKNİK DETAYLAR / Details

> Basıncılı Zamak Metal Malzeme

Deco Serisi

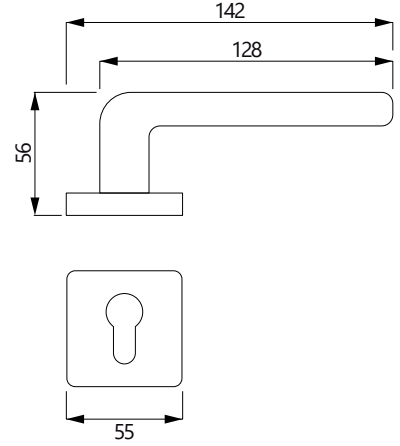
Krom Saten
Chrome SatinKrom Siyah
Satin BlackAntrasit Siyah
Anthracite Black

Oda	0	333214	333217	333220
Yale	1	333215	333218	333221
W.C	2	333216	333219	333222

TEKNİK DETAYLAR

> Basıncılı Zamak Metal Malzeme

Logo Serisi

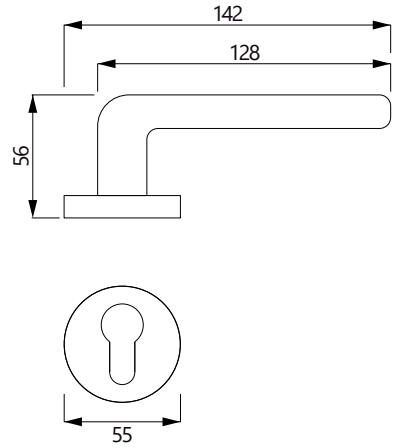
Krom Beyaz
Chrome WhiteTitanyum Siyah
Titanium BlackAntrasit Siyah
Anthracite Black



Oda	0	333229	333226	333223
Yale	1	333230	333227	333224
W.C	2	333231	333228	333225

TEKNİK DETAYLAR / Details

> Basıncılı Zamak Metal Malzeme

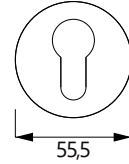
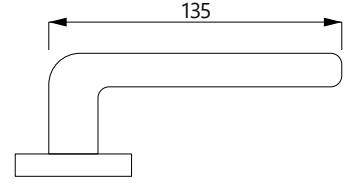
Vola Serisi







	Krom Chrome	Saten Satin Nickel	Antik Olifka Antique	Albrifin Brass	Siyah Black
Oda 	333169	333172	333174	327763	333177
Yale 	333170	320177	333175	327765	333178
W.C. 	333171	333173	333176	327764	333179

TEKNİK DETAYLAR

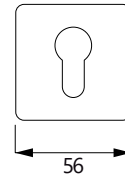
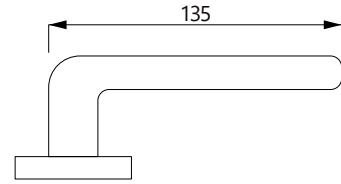
> Basıncılı Zamak Metal Malzeme

Nova Serisi



	Krom Chrome	Saten Satin Nickel	Antik Olifka Antique	Albrifin Brass	Siyah Black
Oda 	333181	319768	333180	333184	321389
Yale 	333182	319770	321335	333185	321390
W.C. 	333183	319769	326979	333186	321391

TEKNİK DETAYLAR / Details

> Basıncılı Zamak Metal Malzeme

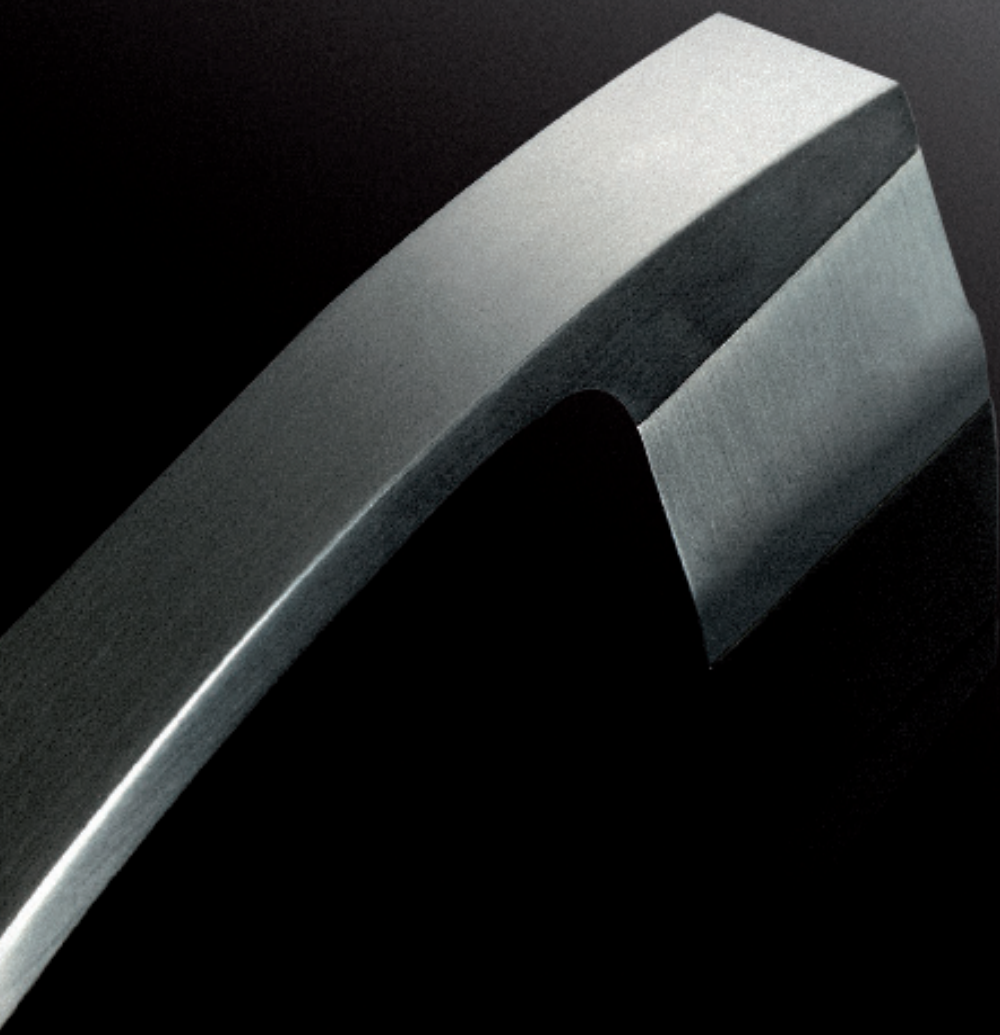

1 One
PIECE

0 Zero
ROSE

Lotus Serisi

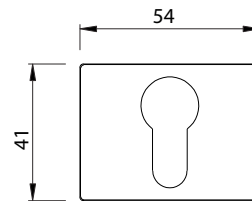
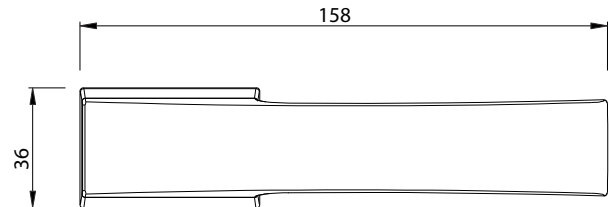
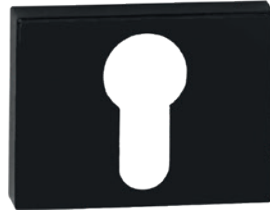

Saten
Satin Nickel



Siyah
Black



Oda	0	328458	328461
Yale	1	328459	328462
W.C	2	328460	328463

TEKNİK DETAYLAR / Details

> Basıncılı Zamak Metal Malzeme

Arco Serisi

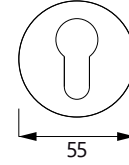
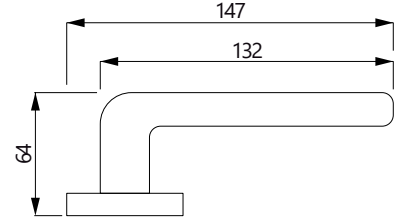

Krom
Chrome



Saten
Satin Nickel



Antik
Antique



Altın
Brass



Siyah
Black



Oda 

333283

333286

333289

333292

333295

Yale 

333284

333287

333290

333293

333296

W.C. 

333285

333288

333291

333294

333297

TEKNİK DETAYLAR

> Basıncılı Zamak Metal Malzeme

Filo Serisi

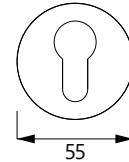
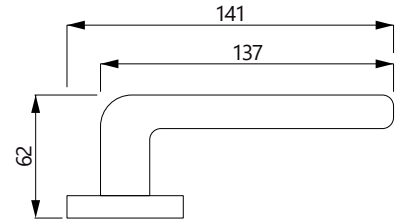

Krom
Chrome



Saten
Satin Nickel



Antik
Antique



Altın
Brass



Siyah
Black



Oda 

333298

333301

333304

333307

333310

Yale 

333299

333302

333305

333308

333311

W.C. 

333300

333303

333306

333309

333312

TEKNİK DETAYLAR / Details

> Basıncılı Zamak Metal Malzeme

Flamina Serisi

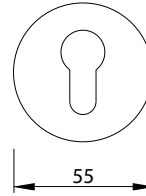
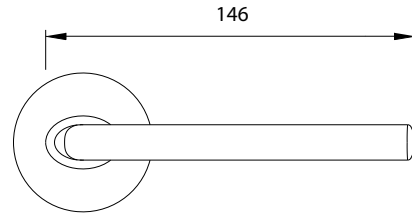

Krom
Chrome



Saten
Satin Nickel



Altın
Brass



Antrasit
Anthracite



Oda 

328530

328524

328533

328527

Yale 

328531

328525

328534

328528

W.C. 

328532

328526

328535

328529

TEKNİK DETAYLAR / Details

> Basıncılı Zamak Metal Malzeme



Mia Serisi

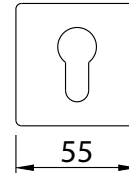
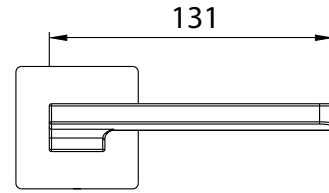
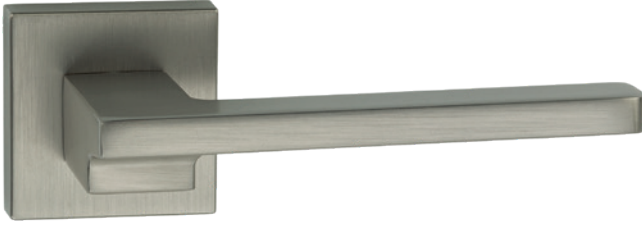

Krom
Chrome



Saten
Satin Nickel



Antik
Antique



Altın
Brass



Siyah
Black



Oda



332893

332896

332899

332902

332905

Yale



332894

332897

332900

332903

332906

W.C



332895

332898

332901

332904

332907

TEKNİK DETAYLAR / Details

- > Basıncılı Zamak Metal Malzeme
- > Renkler/ Kaplama ; Krom,Saten,Antik Bronz, Saten Altın



Trend Serisi

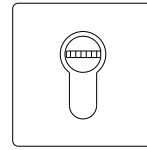
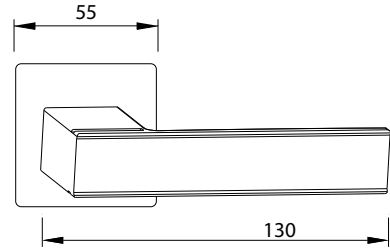
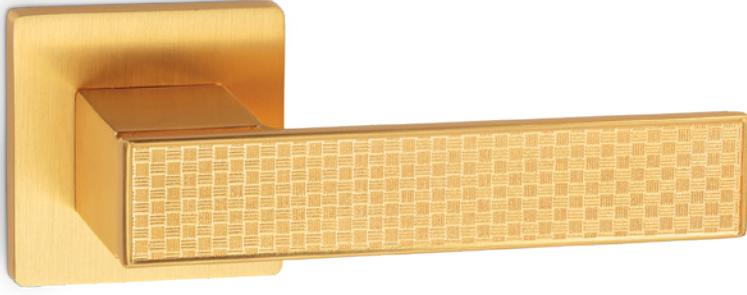

Krom
Chrome



Saten
Satin Nickel



Antik
Antique





Saten Altın
Satin Brass



Siyah
Black



Oda 	328446	328449	328452	328455	332861
Yale 	328447	328450	328453	328456	332862
W.C 	328448	328451	328454	328457	332863

TEKNİK DETAYLAR / Details

> Basınçlı Zamak Metal Malzeme

Punto Serisi

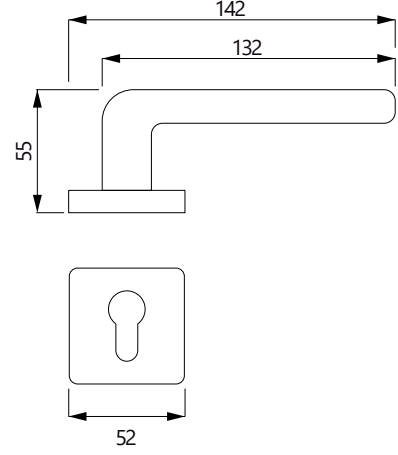
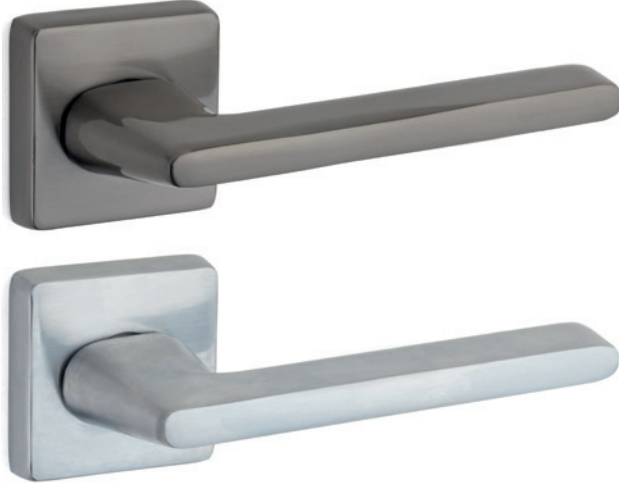

	Krom Chrome	Saten Satin Nickel	Antik Antique	Altın Brass	Siyah Black
Oda	333252	333255	333258	333261	333264
Yale	333253	333256	333259	333262	333265
W.C	333254	333257	333260	333263	333266

TEKNİK DETAYLAR / Details

> Basıncılı Zamak Metal Malzeme

Preso Serisi

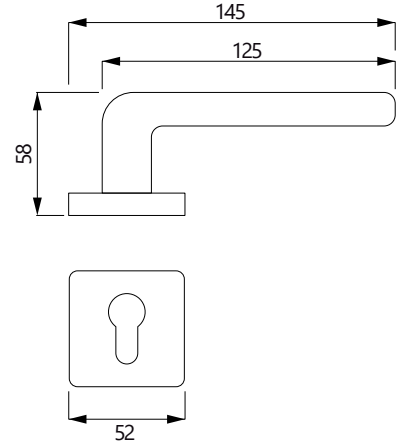

	Krom Chrome	Saten Satin Nickel	Antik Antique	Altın Brass	Siyah Black
Oda	333267	333270	333273	333276	333279
Yale	333268	333271	333274	333277	333280
W.C	333269	333272	333275	333278	333281

TEKNİK DETAYLAR / Details

> Basıncılı Zamak Metal Malzeme

Giza Serisi

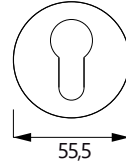
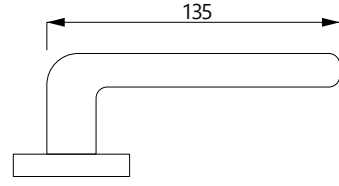

Krom
Chrome



Saten
Satin Nickel

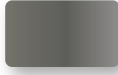

Antik
Antique



Albrifin
Brass



Siyah
Black



Oda

327223

320021

328376

328379

320024

Yale

327224

320023

328378

328381

320026

W.C.

327225

320022

328377

328380

320025

TEKNİK DETAYLAR / Details

> Basınçlı Zamak Metal Malzeme

Recta Serisi

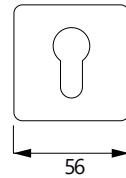
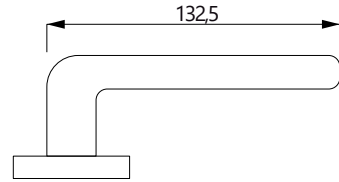

Krom
Chrome



Saten
Satin Nickel



Antik
Antique



Albrifin
Brass



Siyah
Black



Oda

333146

333143

333149

333152

333155

Yale

333147

333144

333150

333153

333156

W.C.

333148

333145



333151

333154

333157

TEKNİK DETAYLAR / Details

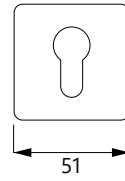
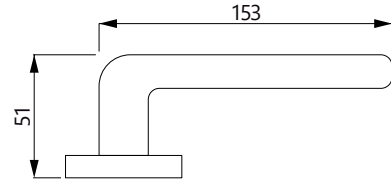
> Basınçlı Zamak Metal Malzeme

Chevron SerisiKrom
ChromeOda  319321Yale  319322W.C.  319323**TEKNİK DETAYLAR / Details**

> Piriç

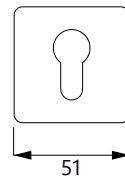
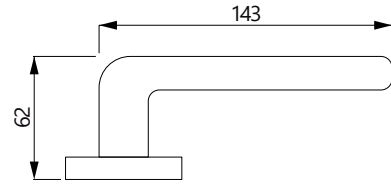
Proje Ürünüdür Lütfen Stok Sorunuz*Lotus Q Serisi**Krom
ChromeOda  319318Yale  319319W.C.  319320**TEKNİK DETAYLAR / Details**

> Piriç

***Proje Ürünüdür Lütfen Stok Sorunuz**

Total Serisi

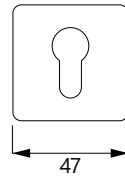
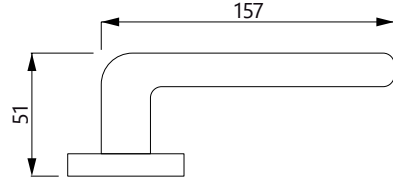

Krom
Chrome



Oda	□	319324
Yale	□	319325
W.C	⊖	319326

TEKNİK DETAYLAR / Details

> Piriç

*Proje Ürünüdür Lütfen Stok Sorunuz

Radial Serisi

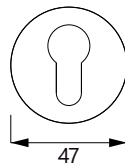
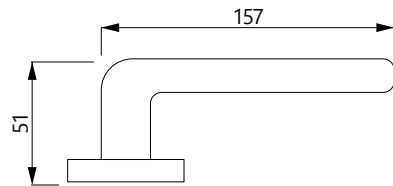

Mat Krom
Matte Chrome



Oda	□	319340
Yale	□	319344
W.C	⊖	319345

TEKNİK DETAYLAR / Details

> Piriç

*Proje Ürünüdür Lütfen Stok Sorunuz



Art Serisi

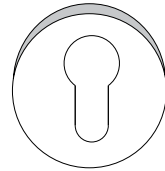
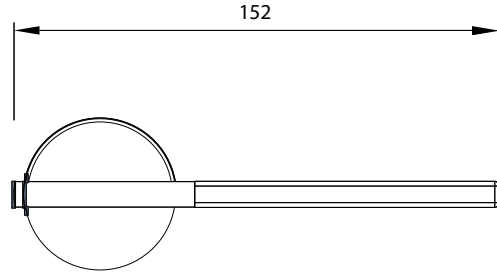

Krom
Chrome



Saten
Satin Nickel



Oda		328440	328443
Yale		328441	328444
W.C		328442	328445

TEKNİK DETAYLAR / Details

> Basıncılı Zamak Metal Malzeme

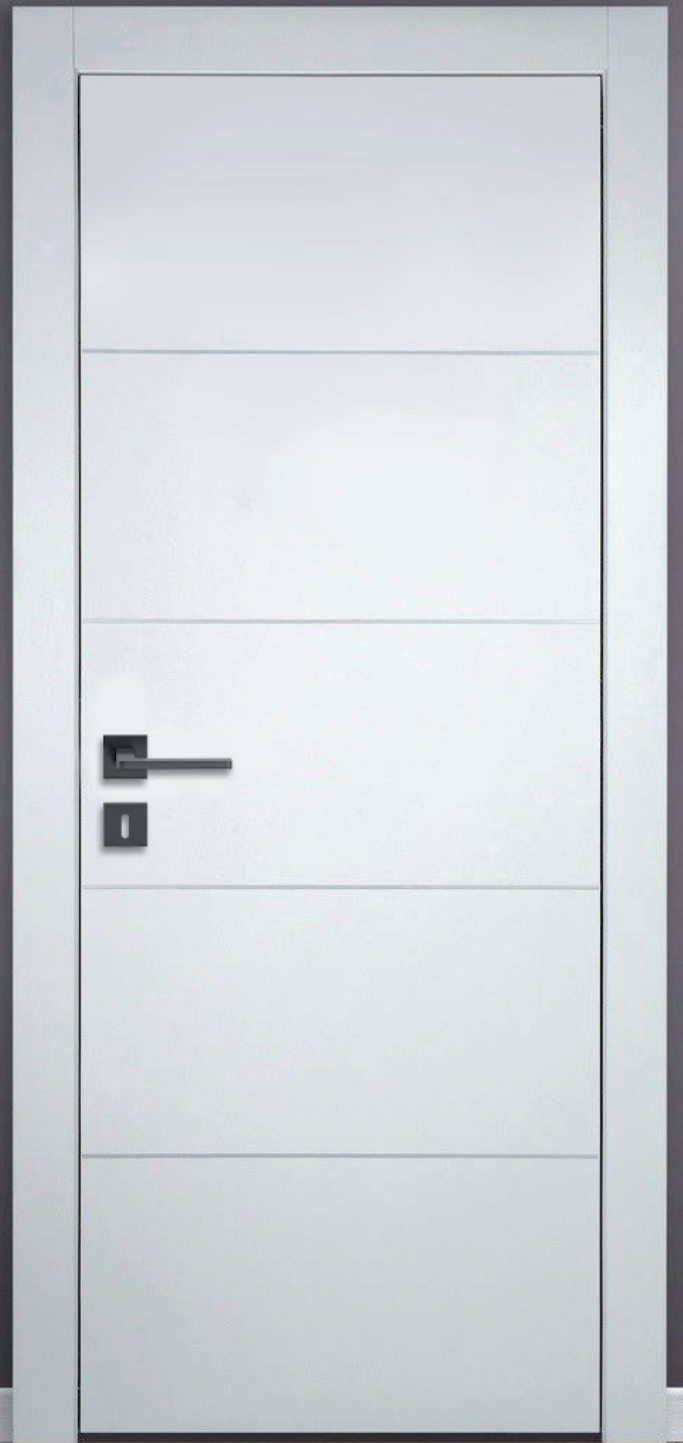
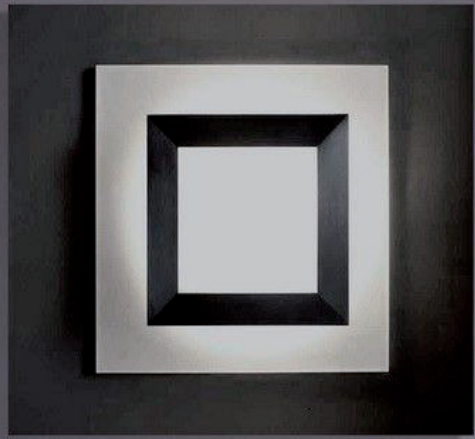

Vanni Serisi

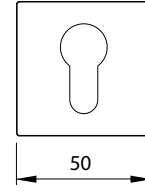
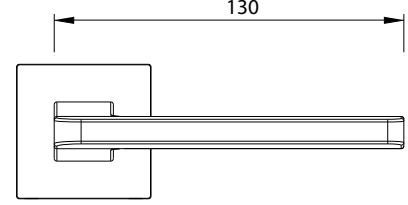

Krom
Chrome



Saten
Satin Nickel



Antik
Antique



Altın
Brass



Siyah
Black



Oda	0	331572	328491	328497	328488	328494
Yale	1	331573	328492	328498	328489	328495
W.C	2	331574	328493	328499	328490	328496

TEKNİK DETAYLAR / Details

> Basıncılı Zamak Metal Malzeme

Enze Serisi

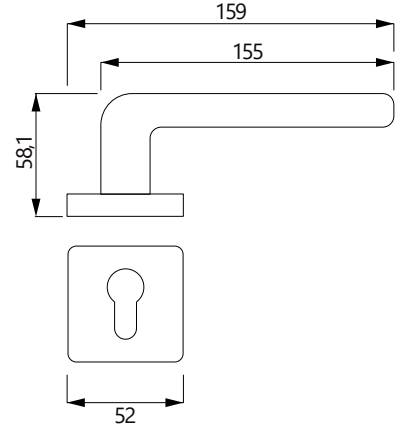

Krom
Chrome



Saten
Satin Nickel



Antik
Antique



Altın
Brass



Siyah
Black



Oda

332995

332998

333001

333007

333004

Yale

332996

332999

333002

333008

333005

W.C.

332997

333000

333003

333009

333006

TEKNİK DETAYLAR / Details

> Basıncılı Zamak Metal Malzeme

Tuke Serisi

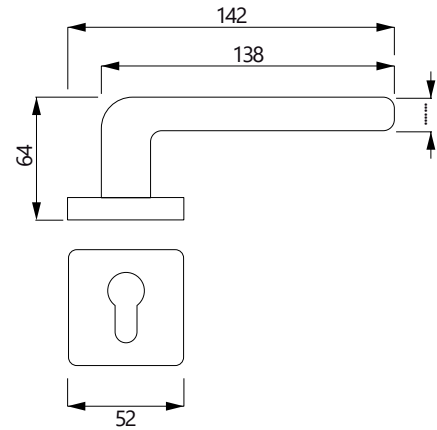

Krom
Chrome



Saten
Satin Nickel



Antik
Antique



Altın
Brass



Siyah
Black



Oda

333079

333082

333085

333088

333091

Yale

333080

333083

333086

333089

333092

W.C.

333081

333084

333087

333090

333093

TEKNİK DETAYLAR / Details

> Basıncılı Zamak Metal Malzeme

Lucca Serisi

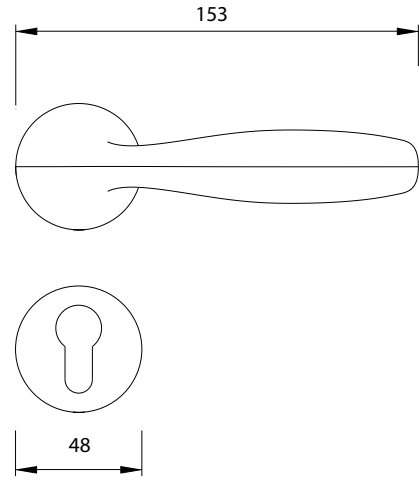

Krom
Chrome



Saten
Satin Nickel



Antik
Antique





Altın
Brass



Siyah
Black





Oda 	328428	328437	335369	328434	328431
Yale 	328429	328438	335370	328435	328432
W.C. 	328430	328439	335371	328436	328433

TEKNİK DETAYLAR / Details

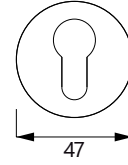
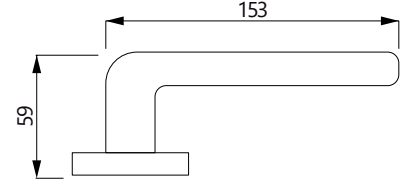
> Basıncılı Zamak Metal Malzeme



Polo Serisi**OLIVARI** Mat Krom
Matte Chrome

Oda		319346
Yale		319347
W.C		319348

TEKNİK DETAYLAR / Details

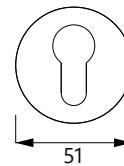
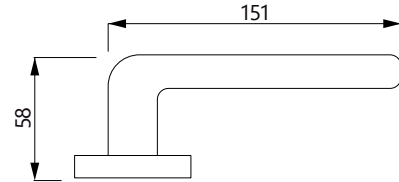
> Piriç

Proje Ürünüdür Lütfen Stok Sorunuz*Moon Serisi****OLIVARI** Mat Krom
Matte Chrome

Oda		319349
Yale		319350
W.C		319351

TEKNİK DETAYLAR / Details

> Piriç

***Proje Ürünüdür Lütfen Stok Sorunuz**

Diana Barley Serisi

OLIVARI

BÖLÜM 14

KAPI KOLLARI

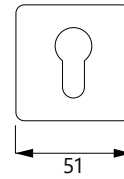
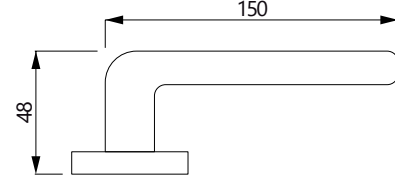
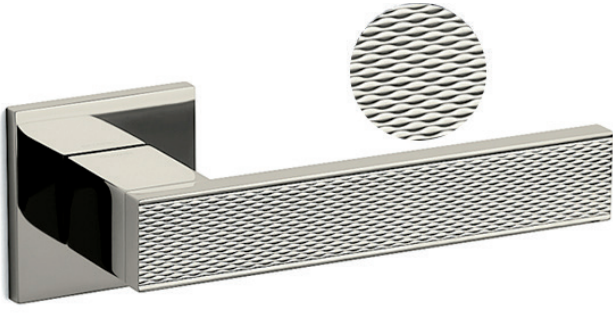

Saten Krom
Satin Chrome



Oda	0	319352
Yale	1	319353
W.C	2	319354

TEKNİK DETAYLAR / Details

> Piriç

*Proje Ürünüdür Lütfen Stok Sorunuz

Atena Ligne Serisi

OLIVARI

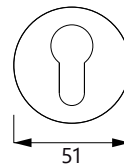
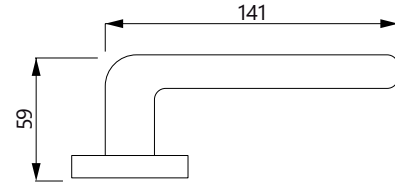
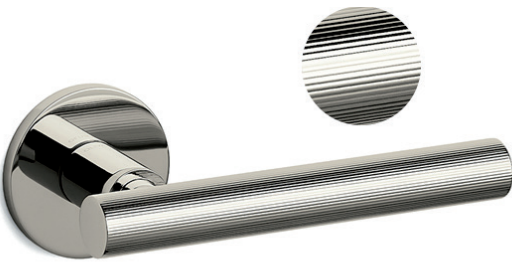

Krom
Chrome



Oda	0	319355
Yale	1	319356
W.C	2	319357

TEKNİK DETAYLAR / Details

> Piriç

*Proje Ürünüdür Lütfen Stok Sorunuz

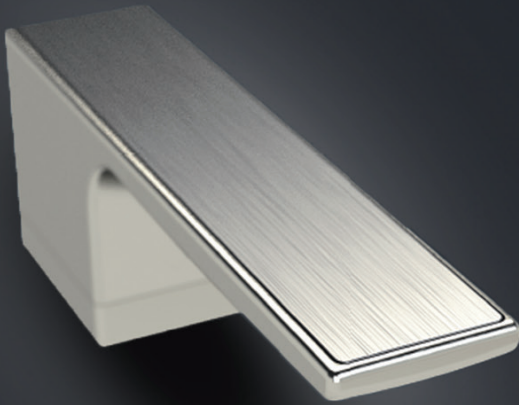

MINIMALIST



Minimalism, Less Is More



Azimut Serisi



Saten / Siyah
Satin / Black



Saten / Saten
Satin / Satin



Oda		328425	328422
Yale		328426	328423
W.C		328427	328424

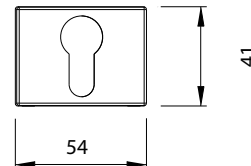
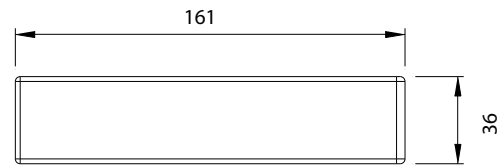

TEKNİK DETAYLAR / Details

> Basınçlı Zamak Metal Malzeme

Rio serisi

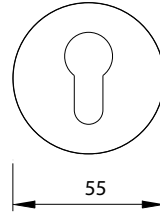
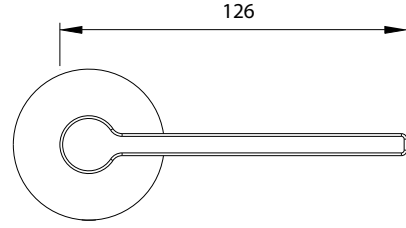
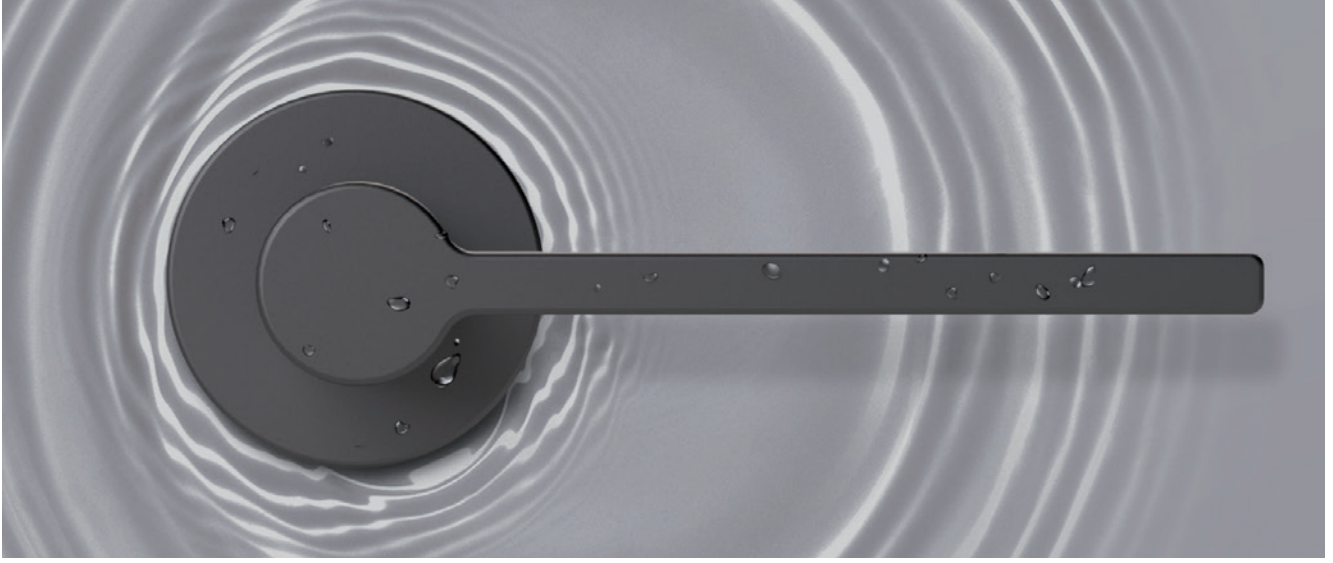

Krom
Chrome



Saten
Satin Nickel



Antik Bronz
Antique Bronze



Altın
Brass



Siyah
Black



Oda

332878

332881

332884

332887

332890

Yale

332879

332882

332885

332888

332891

W.C

332880

332883

332886

332889

332892

TEKNİK DETAYLAR / Details

> Basıncılı Zamak Metal Malzeme

Ultima Serisi

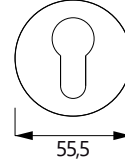
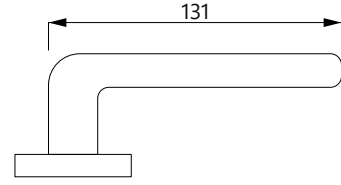

Krom
Chrome



Saten
Satin Nickel



Antik Olifka
Antique Bronze





Albrifin
Brass



Siyah
Black



Oda 	333158	319932	328305	328302	328309
Yale 	333159	327254	328306	328303	328310
W.C. 	333160	327233	328307	328304	328311

TEKNİK DETAYLAR / Details

> Basıncılı Zamak Metal Malzeme

Exa Serisi

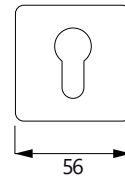
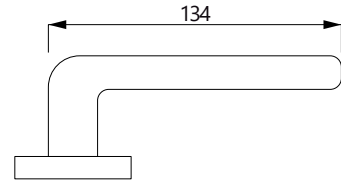

Krom
Chrome



Saten
Satin Nickel



Antik Olifka
Antique Bronze





Albrifin
Brass



Siyah
Black





Oda 	327418	319735	333162	333165	328281
Yale 	327420	319737	333163	333166	328282
W.C. 	327419	319736	333164	333167	328283

TEKNİK DETAYLAR / Details

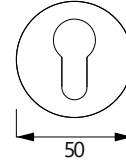
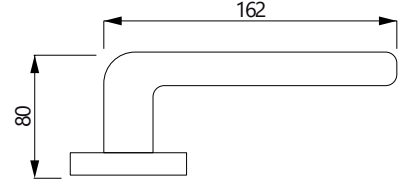
> Basıncılı Zamak Metal Malzeme



Alexandra Serisi**OLIVARI** Krom
Chrome

Oda		319330
Yale		319331
W.C		319332

TEKNİK DETAYLAR / Details

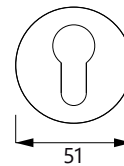
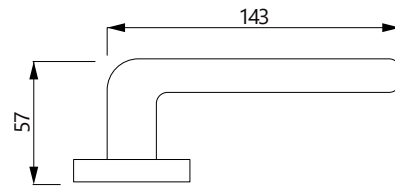
> Pirinç

Proje Ürünüdür Lütfen Stok Sorunuz*Lucy Serisi****OLIVARI** Krom
Chrome

Oda		319333
Yale		319334
W.C		319335

TEKNİK DETAYLAR / Details

> Pirinç

***Proje Ürünüdür Lütfen Stok Sorunuz**

Beta Serisi

OLIVARI

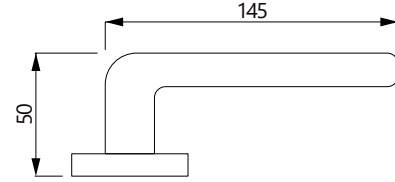

Krom
Chrome



Oda	0	319337
Yale	1	319338
W.C	2	319339

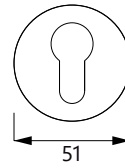

TEKNİK DETAYLAR / Details

> Piriç

*Proje Ürünüdür Lütfen Stok Sorunuz

Lotus Serisi

OLIVARI

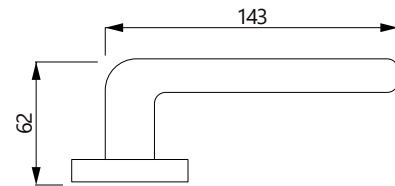

Bakır
Copper



Oda	0	319327
Yale	1	319328
W.C	2	319329

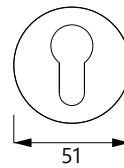

TEKNİK DETAYLAR / Details

> Piriç

*Proje Ürünüdür Lütfen Stok Sorunuz



Olimpia Serisi

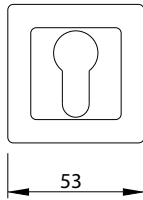
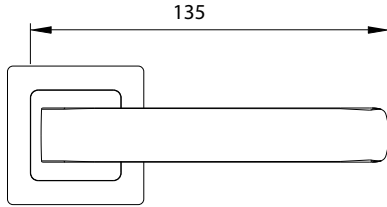
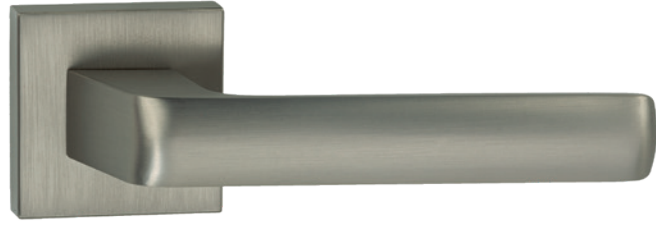
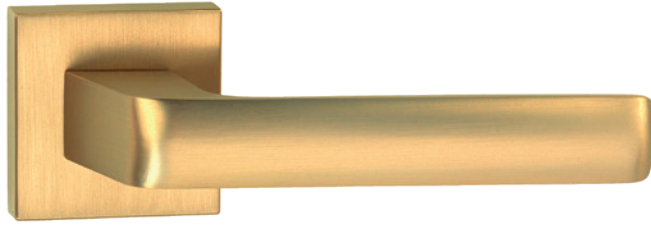

Krom
Chrome



Saten
Satin Nickel



Antik
Antique



Altın
Brass



Siyah
Black



Oda	328518	328512	332873	328521	328515
Yale	328519	328513	332874	328522	328516
W.C	328520	328514	332875	328523	328517

TEKNİK DETAYLAR / Details

> Basıncılı Zamak Metal Malzeme

Enrico Serisi

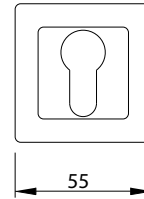
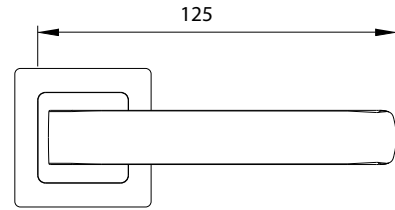
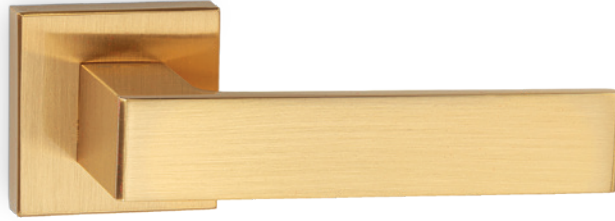
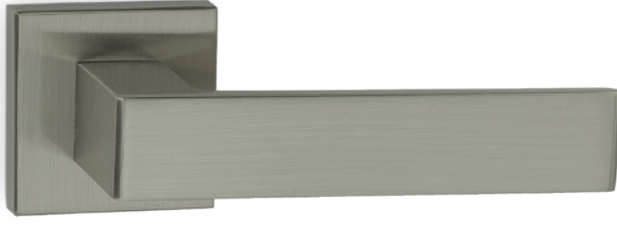

Krom
Chrome



Saten
Satin Nickel



Altın
Brass



Siyah
Black



Oda

328479

328476

328485

328482

Yale

328480

328477

328486

328483

W.C.

328481

328478

328487

328484

TEKNİK DETAYLAR / Details

> Basıncılı Zamak Metal Malzeme

Colorado Serisi

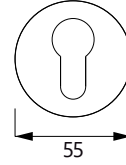
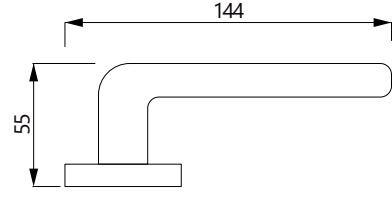

Krom
Chrome



Saten
Satin Nickel



Antik
Antique



Altın
Brass



Siyah
Black



Oda	☐	333313	333316	333319	333322	333325
Yale	☐	333314	333317	333320	333323	333326
W.C	⊖	333315	333318	333321	333324	333327

TEKNİK DETAYLAR / Details

> Basıncılı Zamak Metal Malzeme

Polo Serisi

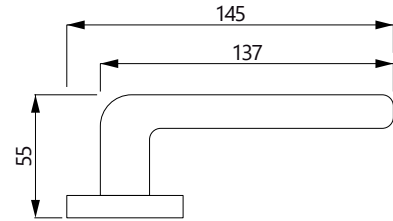

Antik
Antique



Titanyum
Titanium



Oda	☐	333334	333337
Yale	☐	333335	333338
W.C	⊖	333336	333339

TEKNİK DETAYLAR / Details

> Basıncılı Zamak Metal Malzeme

Metro Serisi

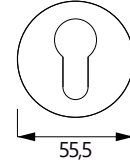
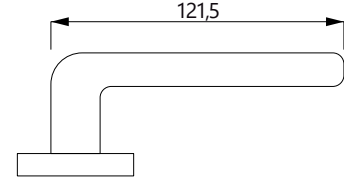

Ç. Saten
Br. Satin



Albirfin
Brass



Oda	🔑	333190	333187
Yale	🔑	333191	333188
W.C	🚻	333192	333189

TEKNİK DETAYLAR / Details

> Basıncılı Zamak Metal Malzeme

Zoe Serisi

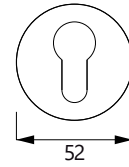
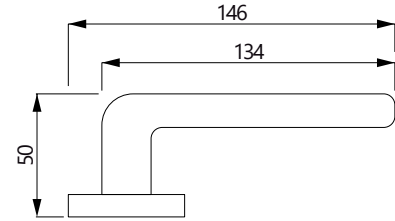

Krom
Chrome



Saten
Satin Nickel



Antik
Antique



Altın
Brass



Siyah
Black



Oda	🔑	315760	315761	315830	320107	314452
Yale	🔑	315762	315763	315831	320109	314454
W.C	🚻	332979	315764	315832	320108	314453

TEKNİK DETAYLAR / Details

> Basıncılı Zamak Metal Malzeme

Due Serisi

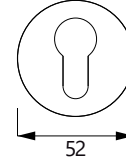
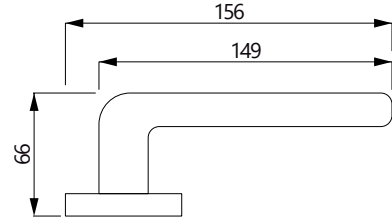
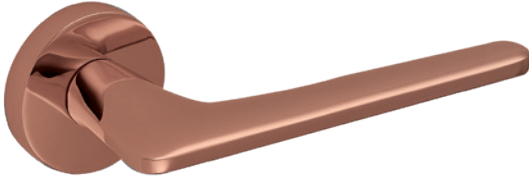

Krom
Chrome



Saten
Satin Nickel



Antik
Antique

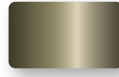

Altın
Brass



Siyah
Black



Oda		332970	328416	332973	332976	328419
Yale		332971	328417	332974	332977	328420
W.C		332972	328418	332975	332978	328421

TEKNİK DETAYLAR / Details

> Basınçlı Zamak Metal Malzeme

Silvia Serisi

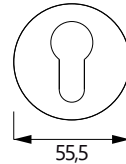
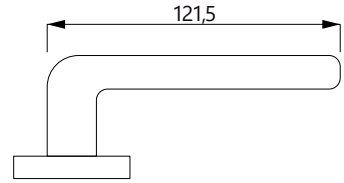

Saten
Satin Nickel



Siyah
Black



Oda		319390	334674
Yale		319392	333194
W.C		319391	333195

TEKNİK DETAYLAR / Details

> Basınçlı Zamak Metal Malzeme

Dallas Serisi



Saten - Gümüş
Satin - Silver



Oda  076171

Yale  076172

W.C.  076173

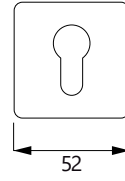
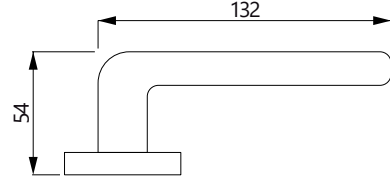

TEKNİK DETAYLAR / Details

> Basıncı Zamak Metal Malzeme

Dublin Serisi



Saten - Gümüş
Satin - Silver



Oda  076184

Yale  076185

W.C.  076186

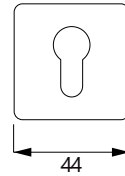
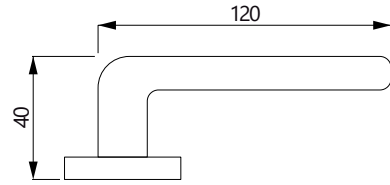

TEKNİK DETAYLAR / Details

> Alüminyum

Birmingham Serisi



Gümüş
Silver



Oda	🔑	076178
Yale	🔑	076179
W.C	⊖	076180

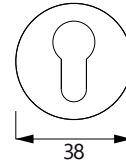
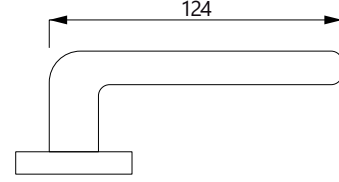

TEKNİK DETAYLAR / Details

> Alüminyum

New York Serisi



Gümüş
Silver



Oda	🔑	003454
Yale	🔑	003450
W.C	⊖	003452

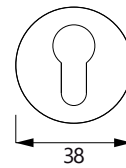
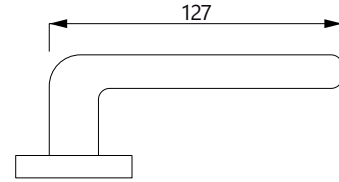

TEKNİK DETAYLAR / Details

> Alüminyum

TH104 Serisi

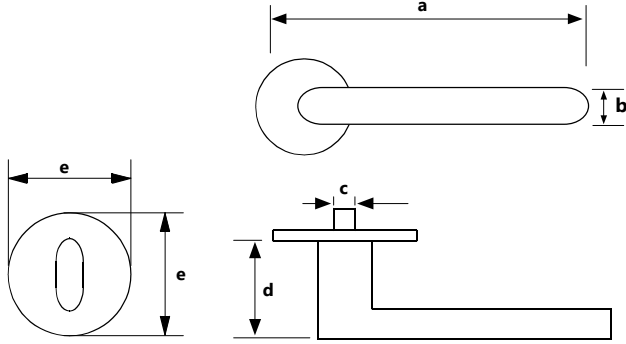

Kod/Code	Açıklama/Description
052711	Soho Kapı Kolu TH104 Paslanmaz 135 mm
055451	Soho Kapı Kolu TH104 Paslanmaz 140 mm
052719	Soho Oda Rozet Paslanmaz
052716	Soho Yale Rozet Paslanmaz
052715	Soho Wc Rozet Paslanmaz
081954	Soho Wc Rozet Paslanmaz İndikatörlü

TEKNİK DETAYLAR / Details

Malzeme : 304 Paslanmaz Çelik

Kod/Code	Ürün Ölçüleri				
	a (mm)	b (mm)	c (mm)	d (mm)	e (mm)
052711	135	19	8	72	52
055451	140	22	8	72	52



TH119 Serisi

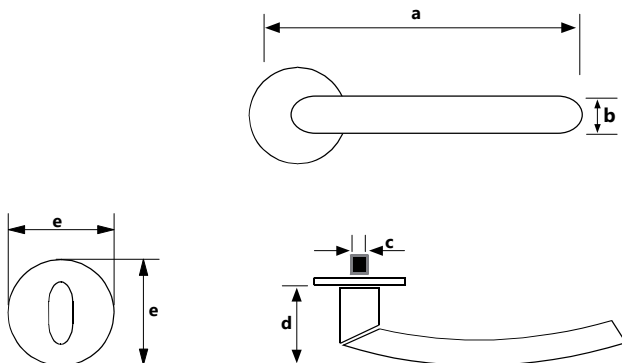

Kod/Code	Açıklama/Description
052714	Soho Kapı Kolu TH119 Paslanmaz
052719	Soho Oda Rozet Paslanmaz
052716	Soho Yale Rozet Paslanmaz
052715	Soho Wc Rozet Paslanmaz
081954	Soho Wc Rozet Paslanmaz İndikatörlü

TEKNİK DETAYLAR / Details

Malzeme: 304 Paslanmaz Çelik

Ürün Ölçüleri				
a (mm)	b (mm)	c (mm)	d (mm)	e (mm)
135	19	8	65	52



TH101 Serisi



Kod/Code	Açıklama/Description
052713	Soho Kapı Kolu TH101 Paslanmaz
052719	Soho Oda Rozet Paslanmaz
052716	Soho Yale Rozet Paslanmaz
052715	Soho Wc Rozet Paslanmaz
081954	Soho Wc Rozet Paslanmaz İndikatörlü

TEKNİK DETAYLAR / Details

Malzeme : 304 Paslanmaz Çelik

Ürün Ölçüleri

a (mm)	b (mm)	c (mm)	d (mm)	e (mm)
130	19	8	65	52

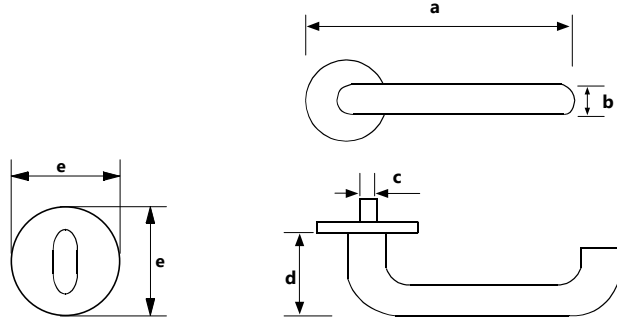
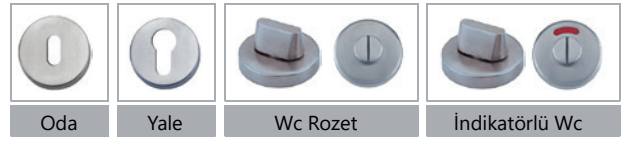

Kare Aynalı Kapı Kolu

Safety-Plate Door Handle Series



Rozet Tipi	Kaplama Rengi	
	Krom	Saten
Oda	072152	071972
Yale	072153	071973
WC	072154	071974

TEKNİK DETAYLAR / Details

> Paslanmaz Çelik Malzeme

	Oda		Wc
	Yale		

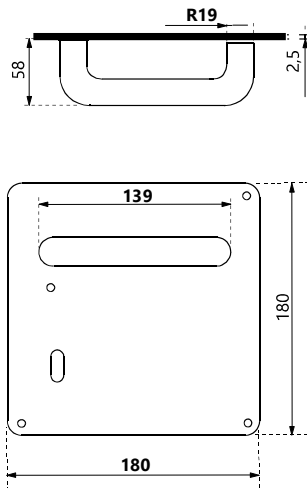



Alfa Serisi

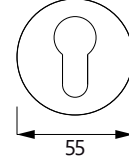
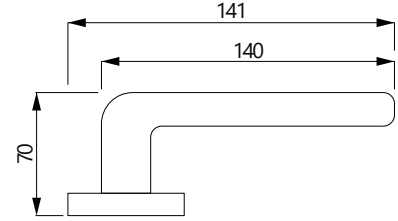

Saten
Satin Nickel



Antik
Antique



Altın
Brass



Siyah
Black



Oda	🔑	333232	333235	333246	333249
Yale	🔑	333233	333236	333247	333250
W.C	🚻	333234	333237	333248	333251

TEKNİK DETAYLAR / Details

> Basıncılı Zamak Metal Malzeme

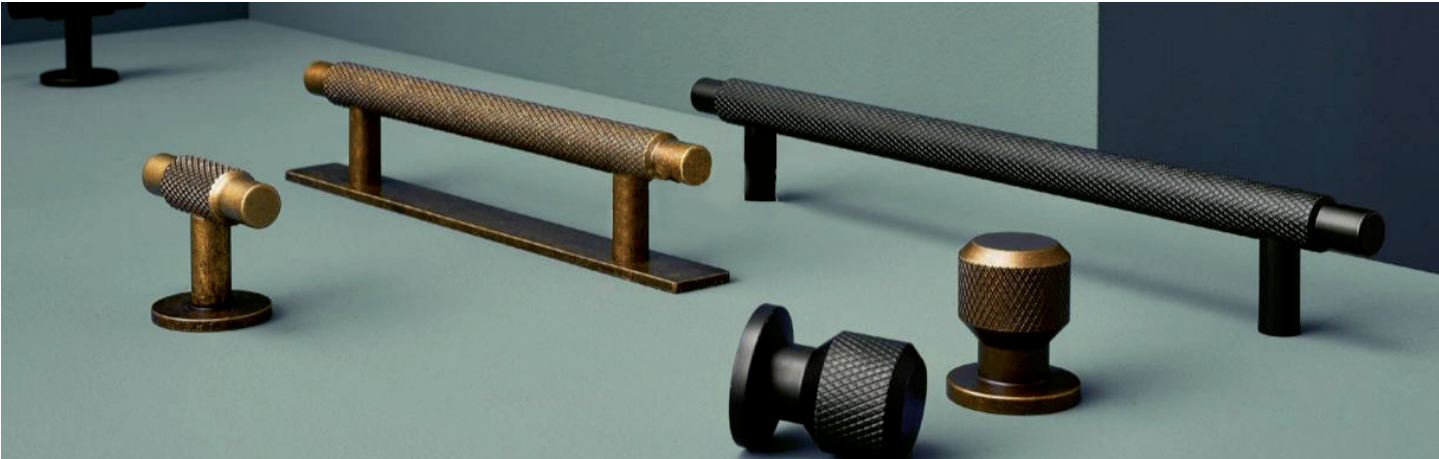

Adele Serisi

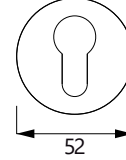
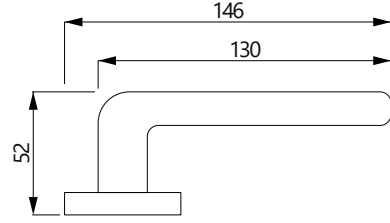

Krom
Chrome



Antik Gümüş
Antique Silver



Antik
Antique



Altın
Brass



Siyah
Black



Oda		332980	332986	332983	332989	332992
Yale		332981	332987	332984	332990	332993
W.C		332982	332988	332985	332991	332994

TEKNİK DETAYLAR / Details

> Basıncılı Zamak Metal Malzeme

Luna Serisi

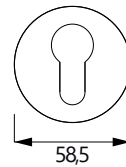
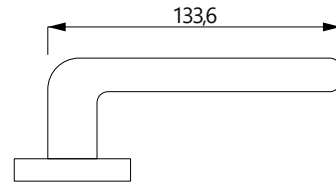

Antik
Antique



Altın
Brass



Siyah
Black



Oda		333125	333128	333131
Yale		333126	333129	333132
W.C		333127	333130	333133

TEKNİK DETAYLAR / Details

> Basıncılı Zamak Metal Malzeme

Elle Serisi

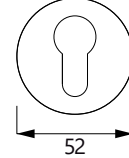
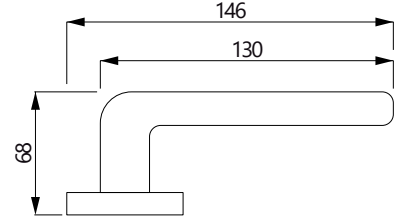

Krom
Chrome

G. Antik
S. Antique

Antik
Antique

Altın
Brass

Siyah
Black



Oda

333040

333046

333043

333049

333052

Yale

333041

333047

333044

333050

333053

W.C.

333042

333048

333045

333051

333054

TEKNİK DETAYLAR / Details

> Basıncılı Zamak Metal Malzeme

Lione Serisi

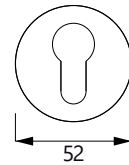
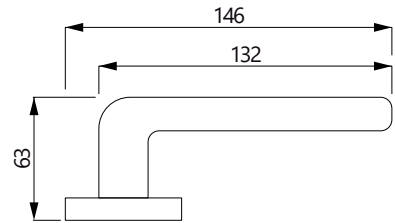

Krom
Chrome

G. Antik
S. Antique

Antik
Antique

Altın
Brass

Siyah
Black



Oda

333055

333061

333058

333064

333067

Yale

333056

333062

333059

333065

333068

W.C.

333057

333063

333060

333066

333069

TEKNİK DETAYLAR / Details

> Basıncılı Zamak Metal Malzeme

Prisma Serisi

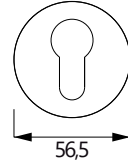
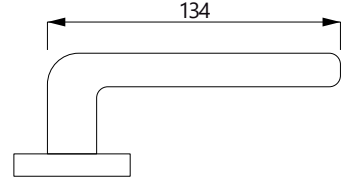

Antik Olifka
Antique



Altın
Brass



Oda	0	327235	333070
Yale	1	327237	333071
W.C	2	327236	333072

TEKNİK DETAYLAR / Details

> Basıncılı Zamak Metal Malzeme

Leva Serisi

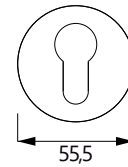
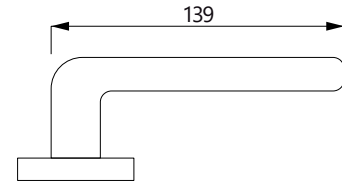
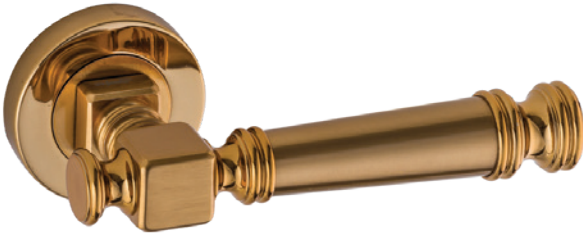

Saten Nikel
Satin Nickel



Antik Olifka
Antique



Altın
Brass



Oda	0	327812	333073	333076
Yale	1	327814	333074	333077
W.C	2	327813	333075	333078

TEKNİK DETAYLAR / Details

> Basıncılı Zamak Metal Malzeme



Siena Serisi





İlgili Ürünler



TEKNİK DETAYLAR / Details



- > Basıncılı Zamak Metal Malzeme
- > Renkler/ Kaplama ; Krom,Saten,Antik Bronz, Saten Altın

	Krom Chrome	Albrifin Brass	Siyah Black
Oda 	333196	321299	333386
Yale 	333197	321300	333387
W.C 	333198	321301	333388



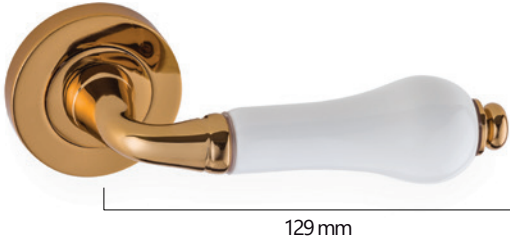

Alba Serisi



	Albrifin Brass	Antik (NAF) Antique
Oda 	327982	333199
Yale 	327984	333200
W.C 	327983	333201



Diana Serisi



	Albrifin Brass	Antik (NAF) Antique
Oda 	333208	333211
Yale 	333210	333212
W.C 	333209	333213

Laura Serisi



	Albrifin Brass	Antik (NAF) Antique
Oda 	333205	333202
Yale 	333206	333203
W.C 	333207	333204

TEKNİK DETAYLAR / Details

- > Basıncılı Zamak Metal Malzeme
- > Renkler/ Kaplama ; Krom,Saten,Antik Bronz, Saten Altın



Petra Serisi



Antik Olifka
Antique



Altın
Brass



Oda 

333118

333121

Yale 

333119

333122

W.C. 

333120

333123

TEKNİK DETAYLAR / Details

- > Basınçlı Zamak Metal Malzeme
- > Renkler/ Kaplama ; Krom,Saten,Antik Bronz, Saten Altın

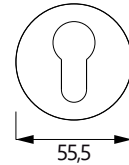
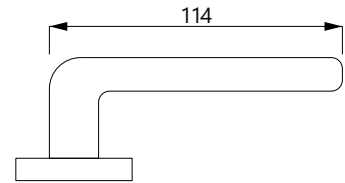

Venere Serisi

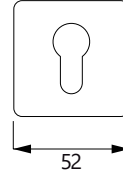
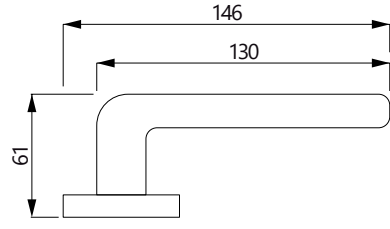

Krom
Chrome



Antik Bronz
Antique Bronze



Gümüş Antik
Antique Silver



Altın
Brass



Siyah
Black



Oda	Ø	315750	333019	320383	333022	333025
Yale	Ø	315751	333020	320384	333023	333026
W.C	⊖	315752	333021	320385	333024	333027

TEKNİK DETAYLAR / Details

- > Basınçlı Zamak Metal Malzeme
- > Renkler/ Kaplama ; Krom,Saten,Antik Bronz, Saten Altın

Blade Serisi

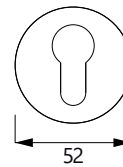
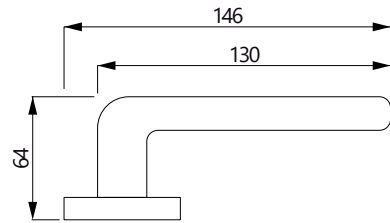

Krom
Chrome



Antik Bronz
Antique Bronze



Gümüş Antik
Antique Silver



Altın
Brass



Siyah
Black



Oda	Ø	333028	315824	333031	333034	333037
Yale	Ø	333029	315826	333032	333035	333038
W.C	⊖	333030	315828	333033	333036	333039

TEKNİK DETAYLAR / Details

- > Basınçlı Zamak Metal Malzeme
- > Renkler/ Kaplama ; Krom,Saten,Antik Bronz, Saten Altın

Meda Serisiİlgili ÜrünlerAntik Olifka
AntiqueSiyah
Black

Oda



327245

328559

Yale



327247

328560

W.C



327246

328561

TEKNİK DETAYLAR / Details

- > Basıncılı Zamak Metal Malzeme
- > Renkler/ Kaplama ; Krom,Saten,Antik Bronz, Saten Altın

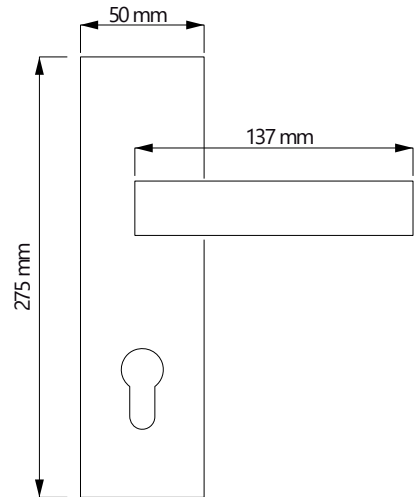

Mexico Serisi

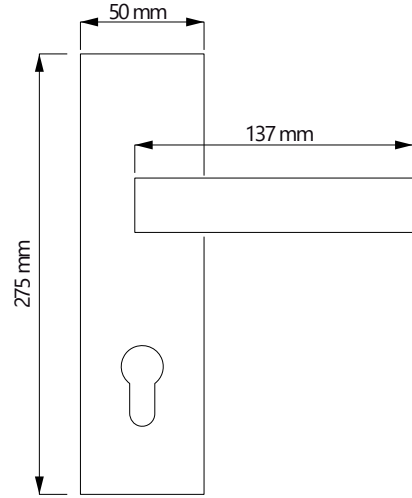

Antik Gümüş
Antique Silver



Antik
Antique



Oda	🔑	333352	333355
Yale	🔑	333353	333356
W.C	🚻	333354	333357

TEKNİK DETAYLAR / Details

- > Basıncılı Zamak Metal Malzeme
- > Renkler/ Kaplama ; Krom,Saten,Antik Bronz, Saten Altın

Theo Serisi



Antik Gümüş
Antique Silver

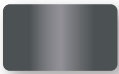

Antik
Antique



Oda	🔑	333358	333361
Yale	🔑	333359	333362
W.C	🚻	333360	333363

TEKNİK DETAYLAR / Details

- > Basıncılı Zamak Metal Malzeme
- > Renkler/ Kaplama ; Krom,Saten,Antik Bronz, Saten Altın

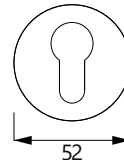
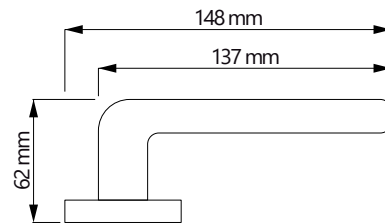

Atlanta Serisi

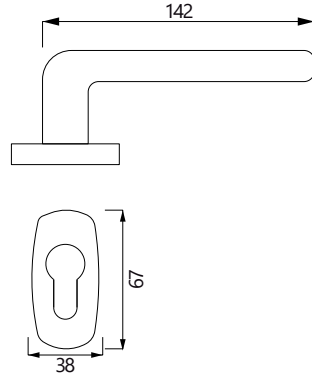

Gümüş - Kumlu
Silver



Oda  076176

Yale  076177

TEKNİK DETAYLAR / Details

- > Alüminyum
- > Renkler/ Kaplama ; Krom,Saten,Antik Bronz, Saten Altın

Bonn Serisi

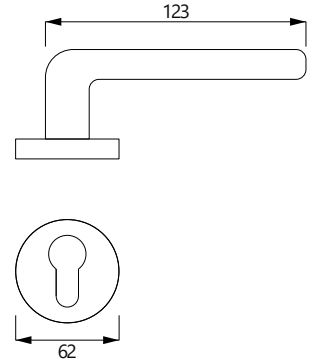

Gümüş
Silver



Oda  076590

TEKNİK DETAYLAR / Details

- > Alüminyum
- > Renkler/ Kaplama ; Krom,Saten,Antik Bronz, Saten Altın

Atlanta Serisi

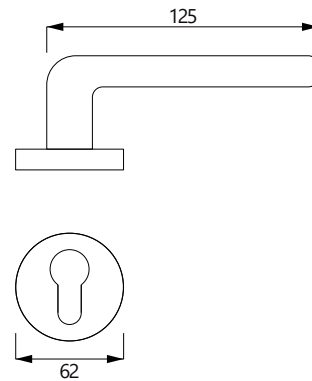
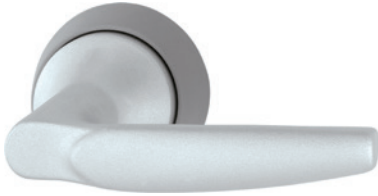

Gümüş
Silver



Oda  076588

TEKNİK DETAYLAR / Details

- > Alüminyum
- > Renkler/ Kaplama ; Krom,Saten,Antik Bronz, Saten Altın

Profil Adaptörü



20 mm Profil İçin

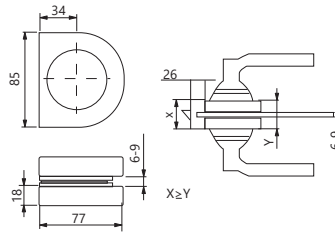

26 mm Profil İçin

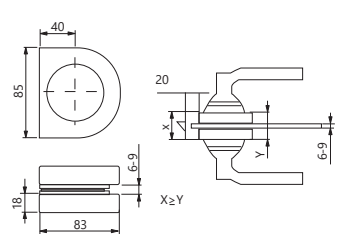

Kod/Code Açıklama/Description

076592	GD A764 20 mm Profil Adaptör Gümüş Mat
076591	GD A763 26 mm Profil Adaptör Gümüş Mat

TEKNİK DETAYLAR / Details

- Malzeme : Alüminyum
- > HCS Alüminyum Kollar İle Uyumludur. GD A764 20 mm Profil Kalınlığı İçindir. GD A763 26 mm Profil Kalınlıklarında Kullanılmaktadır

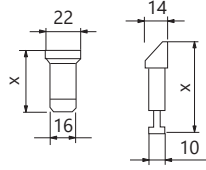
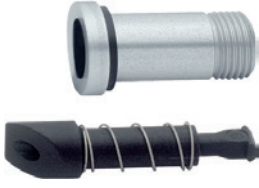

Dil Seti F1/ Door Lock Catch

Kod/Code	Açıklama/Description
076576	Dil Seti Boy 60 mm
076593	Dil Seti Boy 70 mm
076594	Dil Seti Boy 80 mm

TEKNİK DETAYLAR / Details

Malzeme : Alüminyum

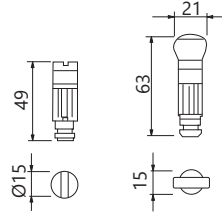

Mandal Gri/ Latch Grey

OL 15-SEN

Kod/Code	Açıklama/Description
076577	Mandal Gri

TEKNİK DETAYLAR / Details

Malzeme : Alüminyum

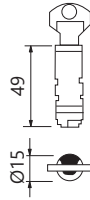

Silindir / Lock Cylinder

Kod/Code	Açıklama/Description
076578	Silindir Anahtar Tek Taraf

TEKNİK DETAYLAR / Details

Malzeme : Alüminyum

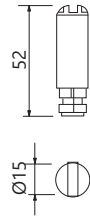

İndikatör / Indicator

Kod/Code	Açıklama/Description
076595	İndikatör 658152 SK-15

TEKNİK DETAYLAR / Details

Malzeme : Alüminyum

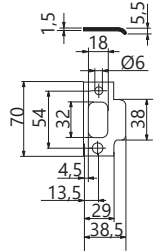

Karşılık / Counterpart

SB-A 38,5x70

Kod/Code	Açıklama/Description
073887	Ahşap Karşılık 38,5 x 70 mm

TEKNİK DETAYLAR / Details

Malzeme : Alüminyum

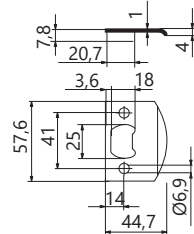

Karşılık / Counterpart

SB-B 45x58

Kod/Code	Açıklama/Description
076597	Ahşap Karşılık 45 x 58 mm

TEKNİK DETAYLAR / Details

Malzeme : Alüminyum

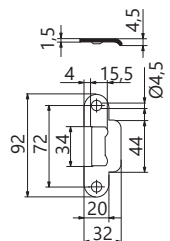

Karşılık / Counterpart

SB-C 32x92

Kod/Code	Açıklama/Description
076596	Ahşap Karşılık 32 x 92 mm

TEKNİK DETAYLAR / Details

Malzeme : Alüminyum

> Cam Kapı Kilitleri İçin (Sayfa 18.14) İnceleyiniz

5020 Serisi

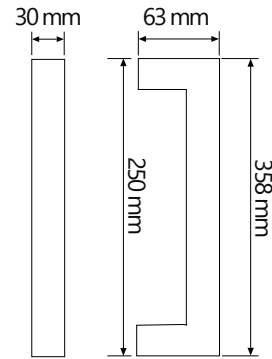

Bronz
Bronze



Antrasit
Antrasite



Altın
Brass



Siyah
Black



Kod / Code

333411

333412

333413

333414

TEKNİK DETAYLAR / Details

> Basıncılı Zamak Metal Malzeme

5030 Serisi

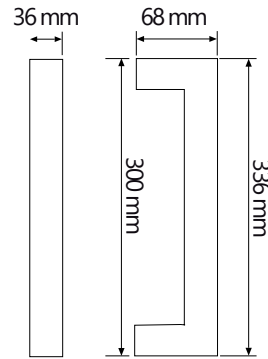

Krom
Chrome

Kod / Code 333406



Altın
Brass

Kod / Code 333407

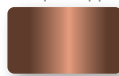

Antik Bronz
Antique Copper

Kod / Code 333408



Antik Demir
Antique Iron

Kod / Code 333409



Siyah
Black

Kod / Code 333410

TEKNİK DETAYLAR / Details

> Basıncılı Zamak Metal Malzeme

3010 Serisi

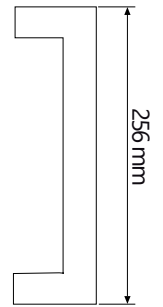

Saten
Satin Nickel



Albirfin
Brass



Antik Bronz
Antique Bronze



Antik Demir
Antique Iron



Kod / Code

333442

333445

333443

333444

TEKNİK DETAYLAR / Details

> Basıncılı Zamak Metal Malzeme

3012 Serisi



	Krom Chrome	Saten Nikel Satin Nickel	Antik Antique	Albrifin Brass	Siyah Black
Kod Code	333397	333396	333398	333399	333400

TEKNİK DETAYLAR / Details

> Basıncılı Zamak Metal Malzeme

3013 Serisi

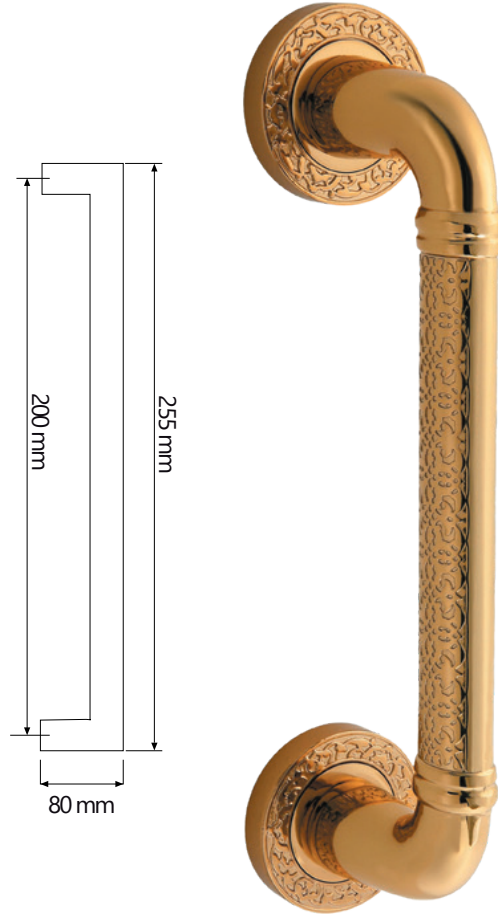

	Albrifin Brass	Antik Bronz Antique Bronze	Antik Demir Antique Iron
Kod Code	328324	328323	327234

TEKNİK DETAYLAR / Details

> Basıncılı Zamak Metal Malzeme



4010 Serisi

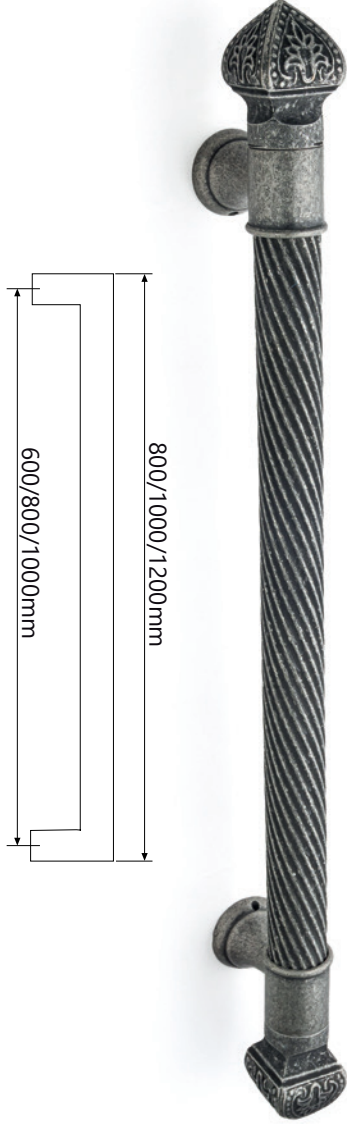

600/800/1000mm
800/1000/1200mm

Altın
Brass



Kod
Code

333446

Antik Bronz
Antique Bronze



333447

Antik Demir
Antique Iron



333448

TEKNİK DETAYLAR / Details

> Basıncılı Zamak Metal Malzeme

3011 Serisi

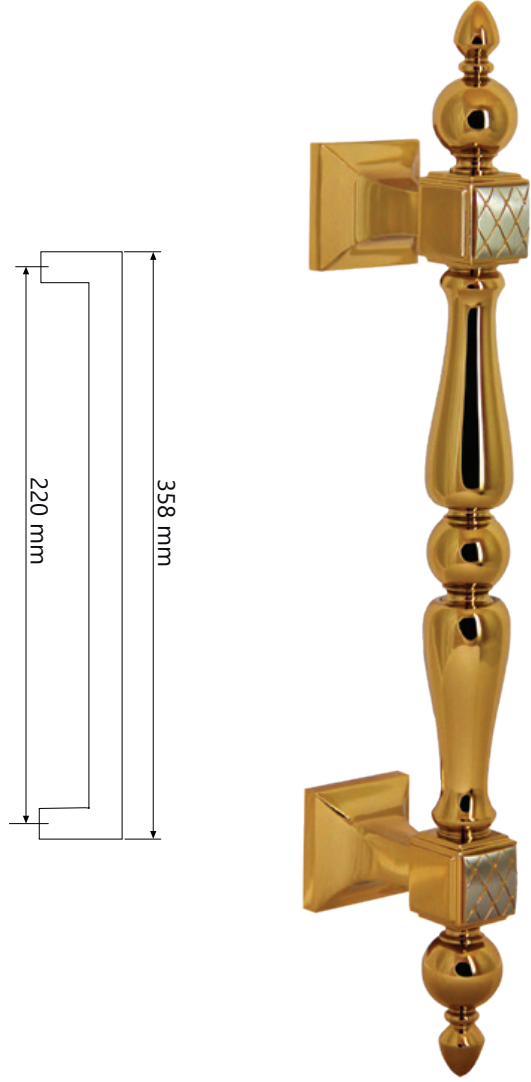

220 mm
358 mm

Albrifin
Brass



Kod
Code

333441

Antik Bronz
Antique Bronze



333439

Antik Demir
Antique Iron



333440

TEKNİK DETAYLAR / Details

> Basıncılı Zamak Metal Malzeme

3015 Serisi

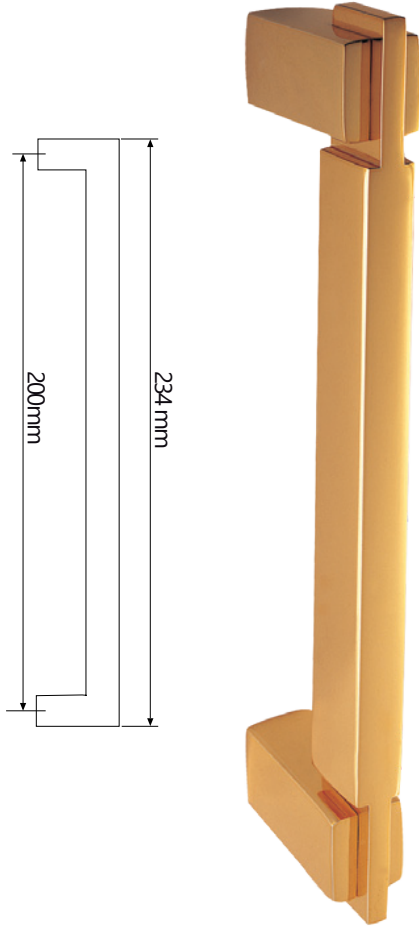

200mm

234 mm



Krom
Chrome



Saten
Satin Nickel



Antik
Antique

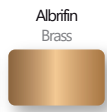

Albrifin
Brass



Siyah
Black

Kod
Code

333430

333429

333431

333432

333433

TEKNİK DETAYLAR / Details

> Basıncılı Zamak Metal Malzeme

3016 Serisi

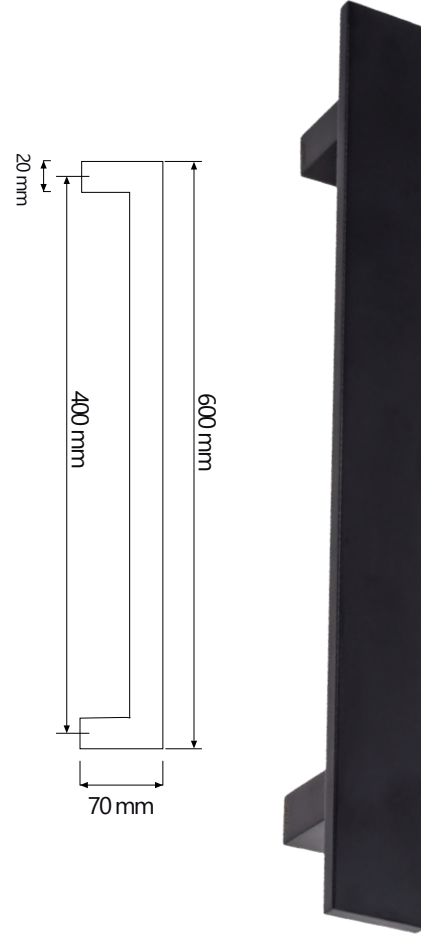

20 mm

400 mm

600 mm

70 mm

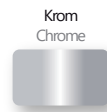

Krom
Chrome



Saten
Satin Nickel

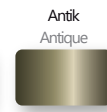

Antik
Antique

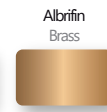

Albrifin
Brass



Siyah
Black

Kod
Code

333415

320405

333416

333417

333418

TEKNİK DETAYLAR / Details

> Basıncılı Zamak Metal Malzeme

3017 Serisi

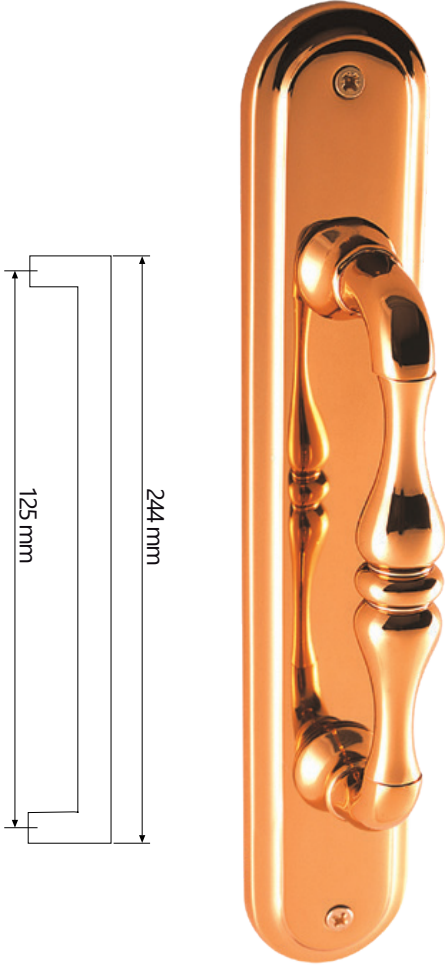

Kod Code	Krom Chrome	Saten Satin Nickel	Antik Antique	Albrifin Brass	Siyah Black
333382					
333383					
333384					
333389					
333390					

TEKNİK DETAYLAR / Details

> Basıncılı Zamak Metal Malzeme

3018 Serisi

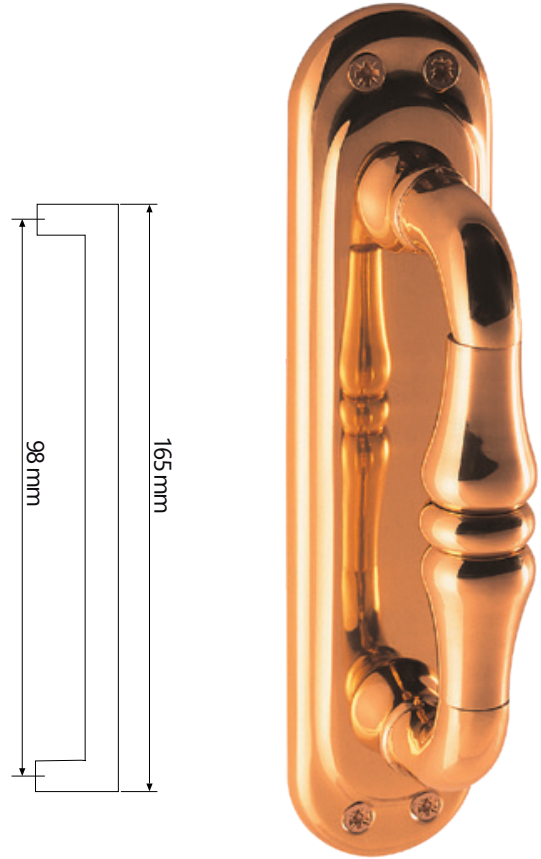

Kod Code	Krom Chrome	Saten Satin Nickel	Antik Antique	Albrifin Brass	Siyah Black
333391					
333392					
333393					
333394					
333395					

TEKNİK DETAYLAR / Details

> Basıncılı Zamak Metal Malzeme

3019 Serisi

3020 Serisi

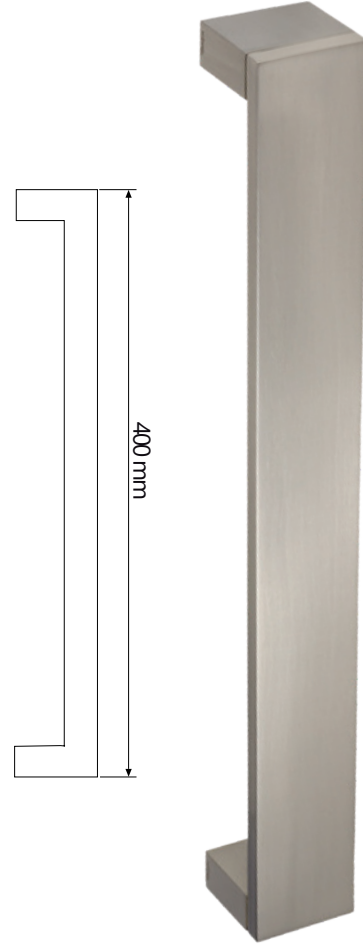
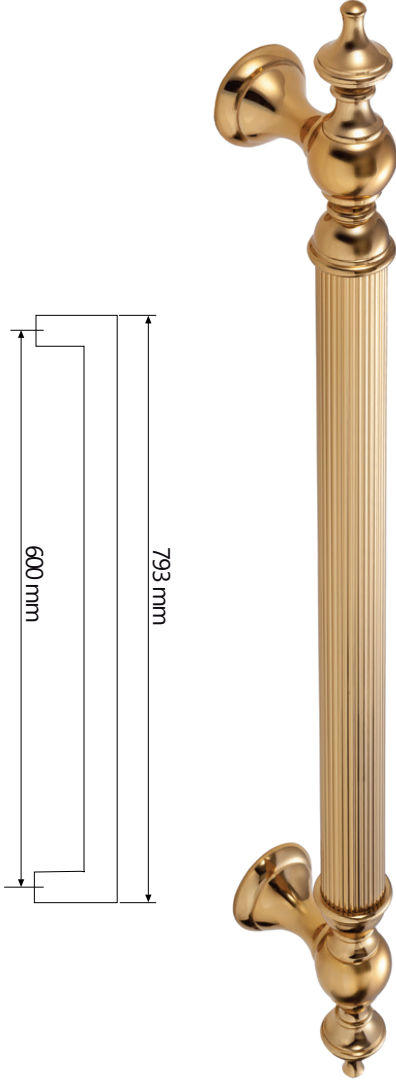

	Albrifin Brass	Antik Bronz Antique Bronze	Antik Demir Antique Iron
Kod	333436	333435	333434
Code			

TEKNİK DETAYLAR / Details

> Basıncılı Zamak Metal Malzeme

	Krom Chrome	Saten Satin Nickel	Antik Antique	Albrifin Brass	Siyah Black
Kod	333401	333402	333403	333404	333405
Code					

TEKNİK DETAYLAR / Details

> Basıncılı Zamak Metal Malzeme

3021 Serisi



Kod Code
327399 333438 333437

TEKNİK DETAYLAR / Details

> Basıncılı Zamak Metal Malzeme

3023 Serisi



Kod Code
333420 333419 333421

TEKNİK DETAYLAR / Details

> Basıncılı Zamak Metal Malzeme



4011 Serisi



	Altın Brass	Antik Bronz Antique Bronze	Siyah Black
Kod Code	333422	333424	333423

TEKNİK DETAYLAR / Details

> Basıncılı Zamak Metal Malzeme

4012 Serisi

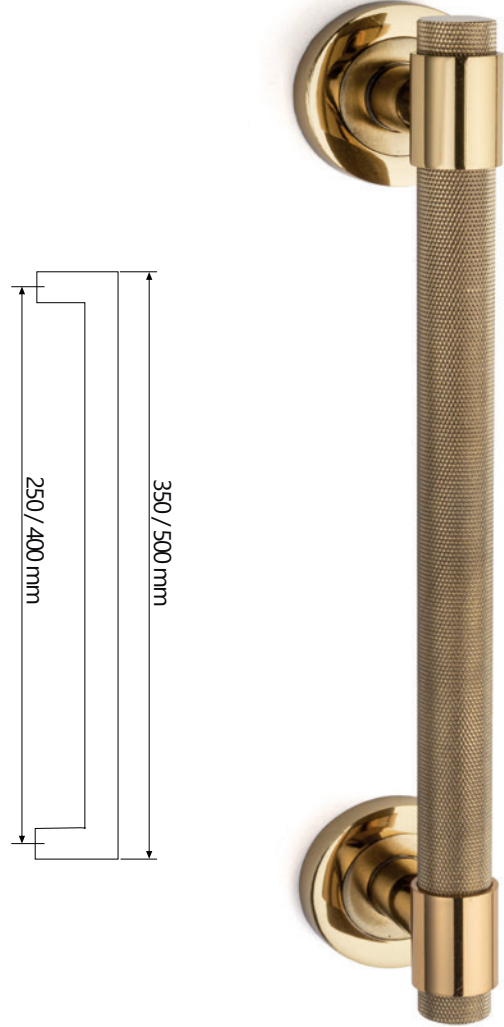

	Altın Brass	Antik Bronz Antique Bronze	Siyah Black
Kod Code	333425	333426	333427

TEKNİK DETAYLAR / Details

> Basıncılı Zamak Metal Malzeme

3024 Serisi



Kod Code	Saten Satin Nickel	Antik Bronz Antique Bronze	Altın Brass	Siyah Black
333452				
333451				
333450				
334318				

TEKNİK DETAYLAR / Details

> Basıncılı Zamak Metal Malzeme

5050 Serisi



Kod Code	Krom Chrome	Saten Satin Nickel	Antik Bronz Antique Bronze	Altın Brass	Siyah Black
333453					
333454					
333455					
333456					
333457					

TEKNİK DETAYLAR / Details

> Basıncılı Zamak Metal Malzeme

5010 Serisi



5040 Serisi



Kod	Krom Chrome	Saten Satin Nickel	Antik Antique	Altın Brass	Siyah Black
Code	333458	333459	333461	333460	333462

Kod	Krom Chrome	Saten Satin Nickel	Antik Antique	Altın Brass	Siyah Black
Code	333463	331563	333467	331565	331564

TEKNİK DETAYLAR / Details

> Basıncılı Zamak Metal Malzeme

TEKNİK DETAYLAR / Details

> Basıncılı Zamak Metal Malzeme

3014 Serisi



Albrifin
Brass



Kod/Code 322243

Antik Bronze
Antique Bronze



320352

Antik Demir
Antique Iron



333428



TEKNİK DETAYLAR / Details

> Basıncılı Zamak Metal Malzeme

3020 Serisi



Krom
Chrome



Saten
Satin Nickel



Antik
Antique



Altın
Brass



Siyah
Black



Kod/Code

333468

333469

333470

333473

333472

TEKNİK DETAYLAR / Details

> Basıncılı Zamak Metal Malzeme

Alexandra Rank Serisi

OLIVARI

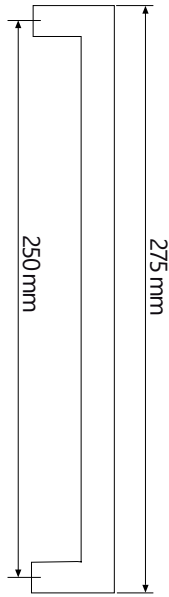

Parlak Krom
Bright Chrome



Kod/Code 319380

TEKNİK DETAYLAR / Details

- > Piriç Malzeme, Krom Kaplama
- > Çift Taraflı Bağlantı
- > 8-15 mm Cam Kalınlığı İçin



104 Serisi

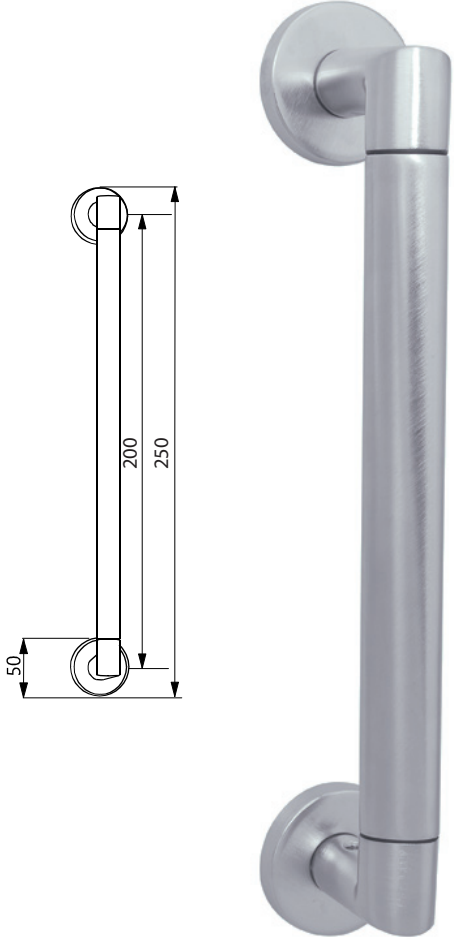

Paslanmaz
Stainless



Kod/Code 315564

TEKNİK DETAYLAR / Details

> Pirinç

827 Serisi



Paslanmaz
Stainless



Kod/Code 070697

TEKNİK DETAYLAR / Details

- > Paslanmaz Çelik, Saten Kaplama
- > Çift Taraflı Bağlantı
- > 8-15 mm Cam Kalınlığı İçin

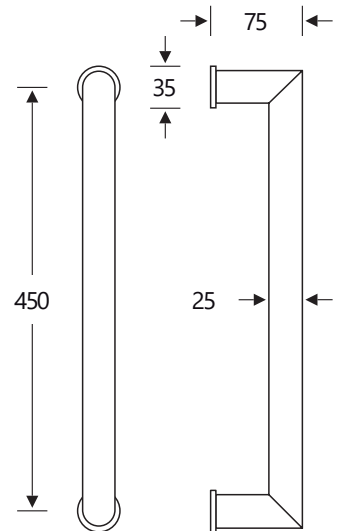



1013 Serisi

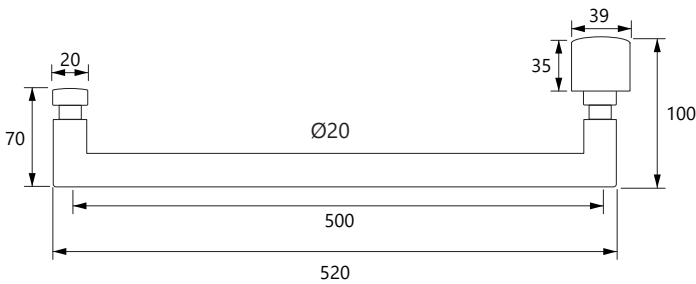

Kod	Krom Chrome	Saten Satin Nickel	Siyah Black	Altın Brass
Code	333990	333991	333992	333993

TEKNİK DETAYLAR / Details

- > Paslanmaz Çelik
- > Çift Taraflı Bağlantı
- > 6 - 12 mm Cam Kalınlığı için
- > Krom, Saten, Siyah, Altın ve Alternatif Renk Olanakları

845 Serisi

840 Serisi

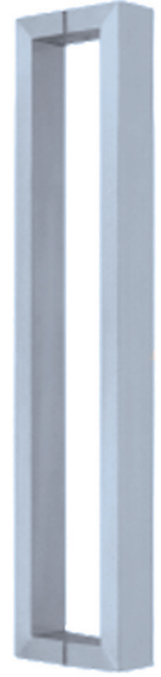
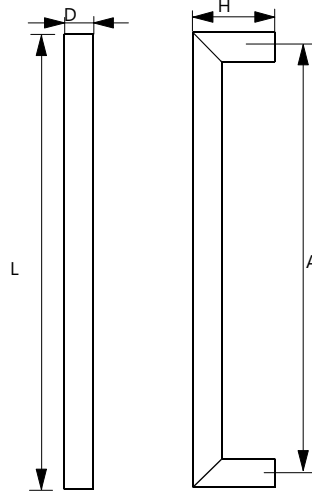
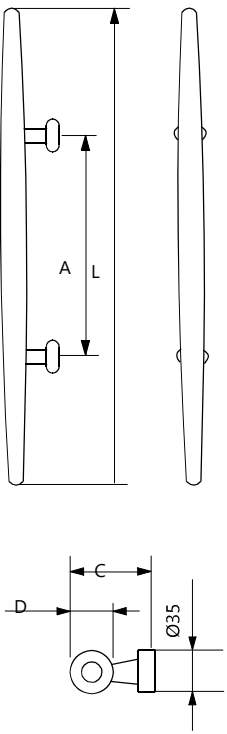

Paslanmaz
Stainless



Kod Code 066534

mm	D	A	L	C
Ø38 x 600	Ø38	275	600	80

TEKNİK DETAYLAR / Details

- > Paslanmaz Çelik, Saten Kaplama
- > Çift Taraflı Bağlantı
- > 8-15 mm Cam Kalınlığı İçin

Saten
Satin



Kod Code 066535 450x475x65 mm
081709 600x615x60 mm

mm	A	H	D (Ø)
475	450	65	50 x 25
615	600	60	30 x 15

TEKNİK DETAYLAR / Details

- > Paslanmaz Çelik, Saten Kaplama
- > Çift Taraflı Bağlantı
- > 8-15 mm Cam Kalınlığı İçin

827C Serisi

211 Serisi

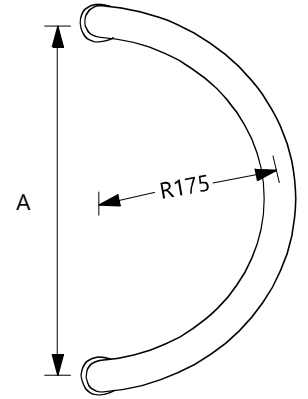
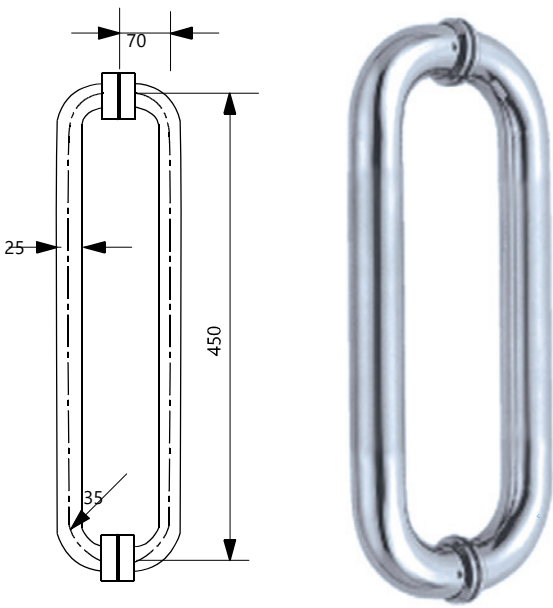

Kod
Code 070726 Ø25 x 450 mm

mm	D (Ø)	A	D	R
Ø25 x 450	25	450	70	35

TEKNİK DETAYLAR / Details

- > Paslanmaz Çelik, Saten Kaplama
- > Çift Taraflı Bağlantı
- > 8-15 mm Cam Kalınlığı İçin



Kod
Code 032703 32 x 350 mm

Ø	A
25	200 - 350
32	200 - 350
38	200 - 350

TEKNİK DETAYLAR / Details

- > Paslanmaz Çelik, Saten Kaplama
- > Çift Taraflı Bağlantı
- > 8-15 mm Cam Kalınlığı İçin

226 Serisi

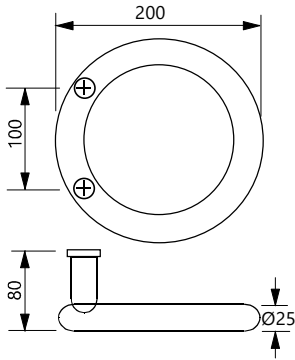

Kod Code 032702 25 x 200 mm

TEKNİK DETAYLAR / Details

- > Paslanmaz Çelik, Saten Kaplama
- > Çift Taraflı Bağlantı
- > 8-15 mm Cam Kalınlığı İçin

2014 Serisi

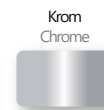
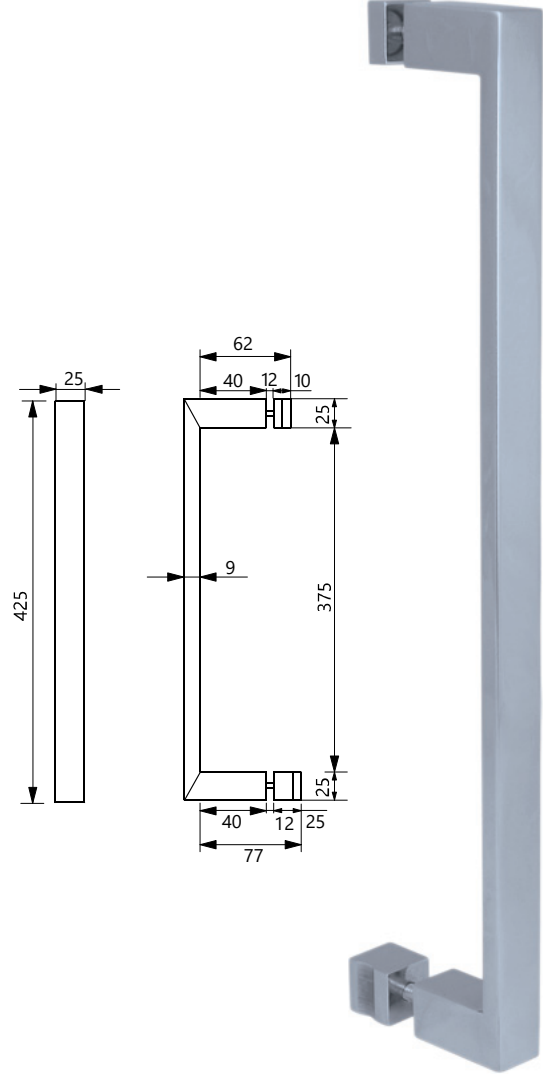

Kod Code 082409 082413 25 x 375 x 425 mm

TEKNİK DETAYLAR / Details

- > Paslanmaz Çelik, Saten Kaplama
- > Çift Taraflı Bağlantı
- > 8-15 mm Cam Kalınlığı İçin

826 Serisi

214 Serisi

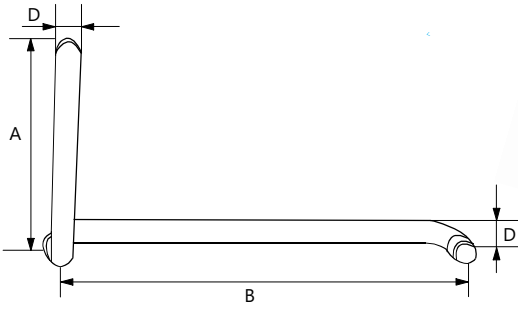

Paslanmaz
Stainless



Kod
Code

070696 Ø19 x 200 x 475 mm
087834 Ø25 x 210 x 415 mm

mm	D (Ø)	A	B
Ø19 x 200 x 450	19	200	475
Ø25 x 210 x 415	25	210	415

TEKNİK DETAYLAR / Details

- > Paslanmaz Çelik, Saten Kaplama
- > Çift Taraflı Bağlantı
- > 6 - 12 mm Cam Kalınlığı İçin

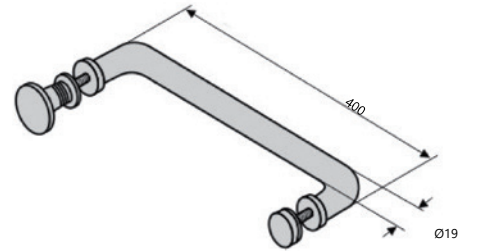

Krom
Chrome



Kod Code 054168

TEKNİK DETAYLAR / Details

- > Paslanmaz Çelik, Saten Kaplama
- > Çift Taraflı Bağlantı
- > 8-15 mm Cam Kalınlığı İçin

205 Serisi

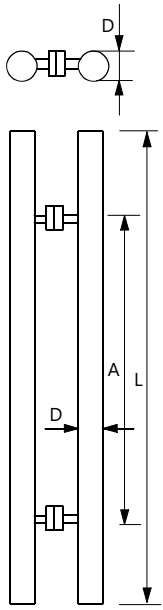

Paslanmaz
Stainless



Kod Code	D (Ø)	A	L
070724	32	400	600
070723	32	625	800
070725	25	300	400
003498	19	200	300

TEKNİK DETAYLAR / Details

- > Paslanmaz Çelik, Saten Kaplama
- > Çift Taraflı Bağlantı
- > 8-15 mm Cam Kalınlığı İçin

285 Serisi

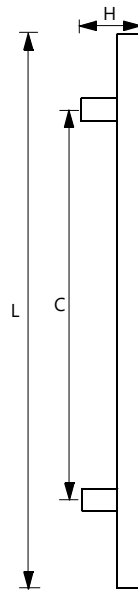

Paslanmaz
Stainless



Kod Code 032700

	L	C	H
25x25	600	426	70

TEKNİK DETAYLAR / Details

- > Paslanmaz Çelik, Saten Kaplama
- > Çift Taraflı Bağlantı
- > 8-15 mm Cam Kalınlığı İçin

283 Serisi

281 Serisi

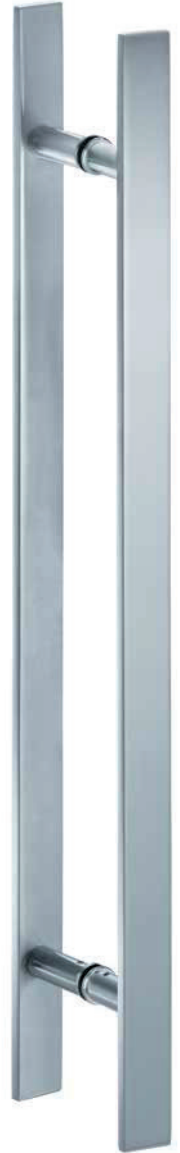
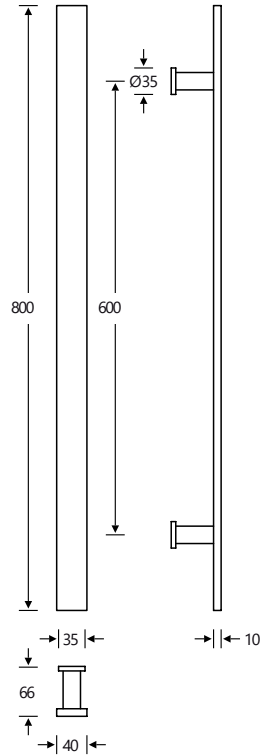
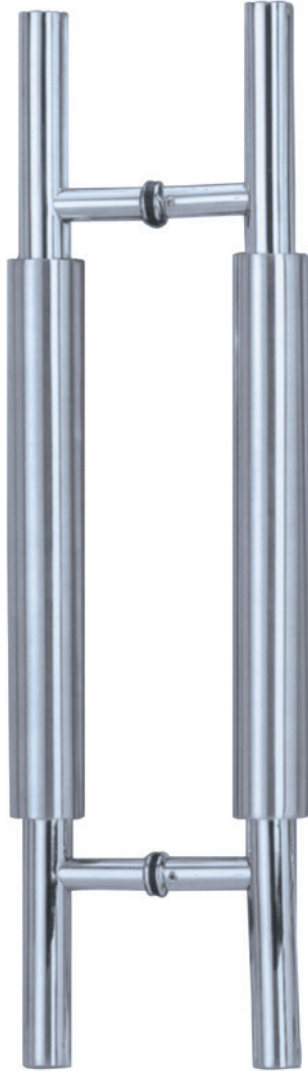
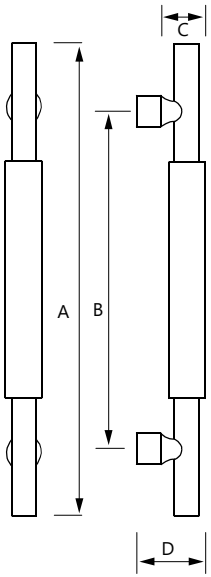

Paslanmaz
Stainless



Kod Code 032701

mm	A	B	C	D
38 x 510	510	430	38	75

TEKNİK DETAYLAR / Details

- > Paslanmaz Çelik, Saten Kaplama
- > Çift Taraflı Bağlantı
- > 8-15 mm Cam Kalınlığı İçin

Paslanmaz
Stainless



Kod Code 333474

TEKNİK DETAYLAR / Details

- > Paslanmaz Çelik, Saten Kaplama
- > Çift Taraflı Bağlantı
- > 8-15 mm Cam Kalınlığı İçin

Link Serisi
OLIVARI

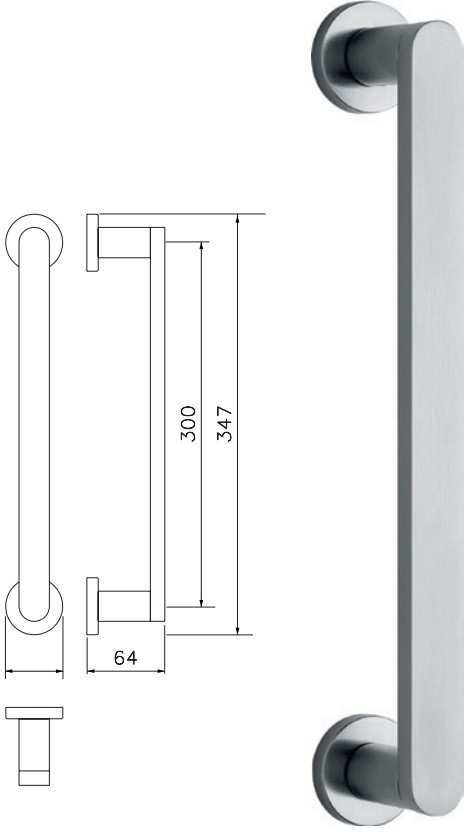

Krom
Chrome



Kod Code 333475

TEKNİK DETAYLAR / Details

- > Paslanmaz Çelik, Saten Kaplama
- > Çift Taraflı Bağlantı
- > 8-15 mm Cam Kalınlığı İçin

PH300-34A Serisi

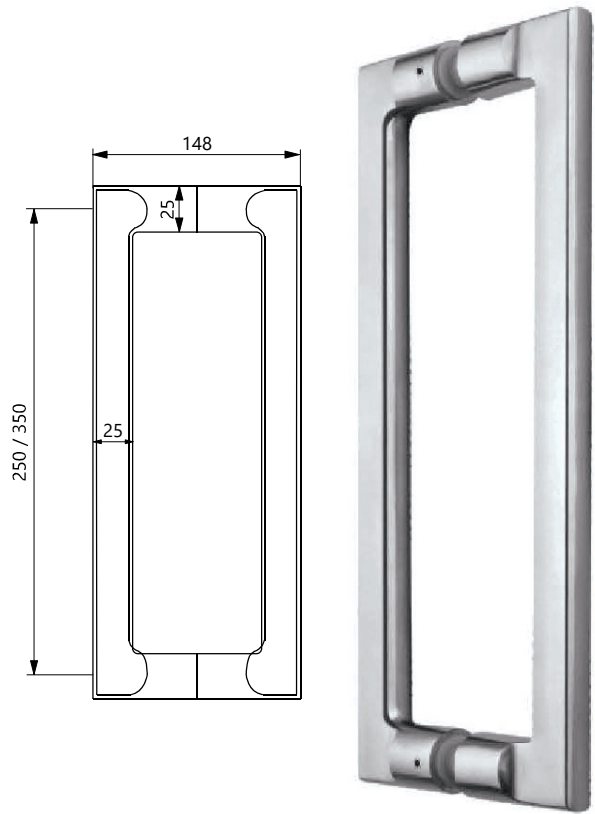

Paslanmaz
Stainless



Kod Code 082385 25 x 25 x 247 mm
082386 25 x 25 x 350 mm

TEKNİK DETAYLAR / Details

- > Paslanmaz Çelik, Saten

901S Hareketli

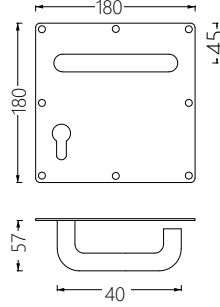

Saten
Satin Nickel



Kod Code 258210

TEKNİK DETAYLAR / Details

> AISI 30 Paslanmaz Çelik

901P Sabit

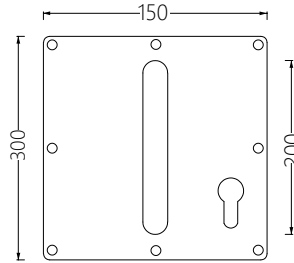

Saten
Satin Nickel



Kod Code 333490

TEKNİK DETAYLAR / Details

> AISI 30 Paslanmaz Çelik

901P Çekme Yazısız

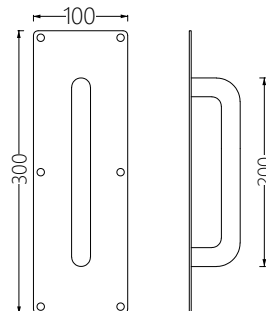

Saten
Satin Nickel



Kod Code 271792

TEKNİK DETAYLAR / Details

> AISI 30 Paslanmaz Çelik

901P Çekme Yazılı

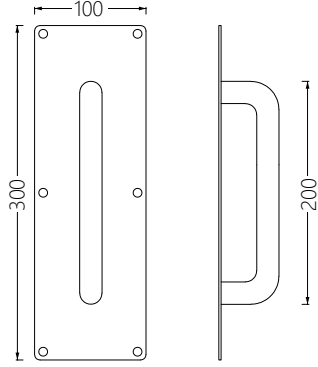

Saten
Satin Nickel



Kod Code 258212

TEKNİK DETAYLAR / Details

> AISI 30 Paslanmaz Çelik

901P İtme Sacı Yazılı

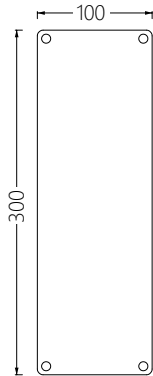

Saten
Satin Nickel



Kod Code 258211

TEKNİK DETAYLAR / Details

> AISI 30 Paslanmaz Çelik





490 Serisi

Altın
Brass



Kod Code 011318

TEKNİK DETAYLAR / Details

- > Basıncılı Zamak Metal Malzeme
- > Renkler/ Kaplama ; Mat Krom,Krom, Saten,Altın Saten,Krom saten,antik



492 Serisi

Saten
Satin Nickel



Kod Code 333491

TEKNİK DETAYLAR / Details

- > Basıncılı Zamak Metal Malzeme
- > Renkler/ Kaplama ; Mat Krom,Krom,Saten



491 Serisi

Antik
Antique



Kod Code 327192

TEKNİK DETAYLAR / Details

- > Basıncılı Zamak Metal Malzeme
- > Renkler/ Kaplama ; Mat Krom,Krom,Saten



493 Serisi

Paslanmaz
Stainless



Kod Code 333492

TEKNİK DETAYLAR / Details

- > Basıncılı Zamak Metal Malzeme
- > Renkler/ Kaplama ; Mat Krom,Krom,Saten

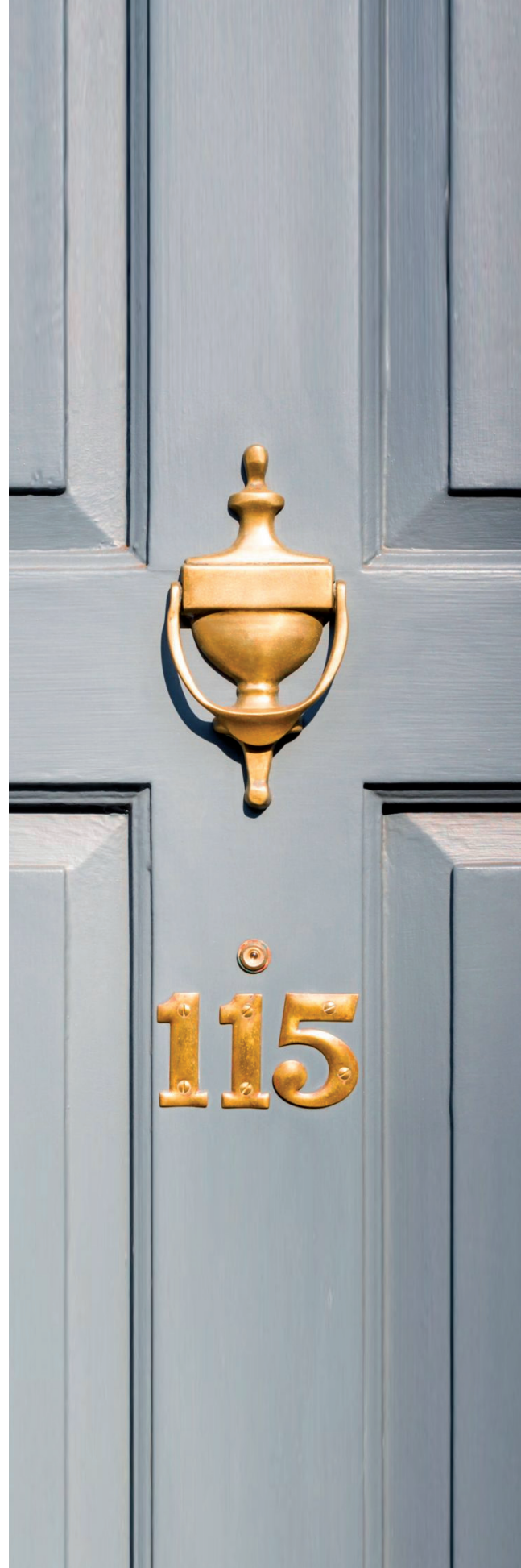

498-6 Serisi

Siyah
Black



Kod Code 333474

TEKNİK DETAYLAR / Details

- > Basıncılı Zamak Metal Malzeme
- > Renkler/ Kaplama ; Mat Krom,Krom,Saten,Altın

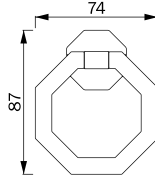

497-5 Serisi

Bakır
Copper



Kod Code 333497

TEKNİK DETAYLAR / Details

- > Basıncılı Zamak Metal Malzeme
- > Renkler/ Kaplama ; Mat Krom,Krom,Saten,Altın

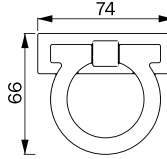

496-1 Serisi

Krom
Chrome



Kod Code 333498

TEKNİK DETAYLAR / Details

- > Basıncılı Zamak Metal Malzeme
- > Renkler/ Kaplama ; Mat Krom,Krom,Saten,Altın

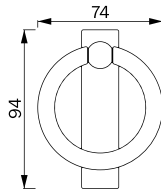

493-4 Serisi

Siyah
Black



Kod Code 333499

TEKNİK DETAYLAR / Details

- > Basıncılı Zamak Metal Malzeme
- > Renkler/ Kaplama ; Mat Krom,Krom,Saten,Altın

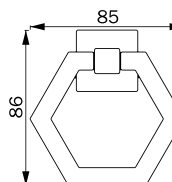

489 Serisi



Saten
Satin



Kod/Code 333495

TEKNİK DETAYLAR / Details

- > Basınçlı Zamak Metal Malzeme
- > Renkler/ Kaplama ; Mat Krom,Krom,Saten,Altın,Antik

488 Serisi



Altın
Brass



Kod/Code 333500

TEKNİK DETAYLAR / Details

- > Basınçlı Zamak Metal Malzeme
- > Renkler/ Kaplama ; Mat Krom,Krom,Saten,Altın,Antik

487 Serisi



Antik
Antique



Kod/Code 333501

TEKNİK DETAYLAR / Details

- > Basınçlı Zamak Metal Malzeme
- > Renkler/ Kaplama ; Mat Krom,Krom,Saten,Altın,Antik



486 Serisi

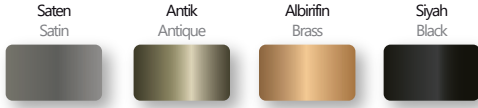
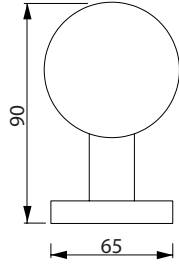

Kod 320159 322773 327191 322774

TEKNİK DETAYLAR / Details

- > Basıncılı Zamak Metal Malzeme
- > Renkler/ Kaplama ; Mat Krom,Krom,Saten

503 Serisi



Kod/Code 333493

TEKNİK DETAYLAR / Details

- > Basıncılı Zamak Metal Malzeme
- > Renkler/ Kaplama ; Mat Krom,Krom,Saten

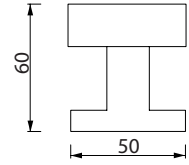

485 Serisi



Kod/Code 333494

TEKNİK DETAYLAR / Details

- > Basıncılı Zamak Metal Malzeme
- > Renkler/ Kaplama ; Mat Krom,Krom,Saten

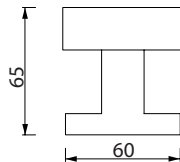

504 Serisi



Kod/Code 320901

TEKNİK DETAYLAR / Details

- > Basıncılı Zamak Metal Malzeme
- > Renkler/ Kaplama ; Mat Krom,Krom,Saten

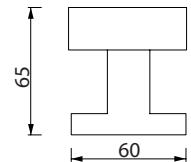

484 TY Serisi

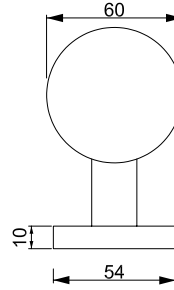
Saten
Satin Nickel

Kod/Code 258208

TEKNİK DETAYLAR / Details

> AISI 30 Paslanmaz Çelik

483 T Serisi

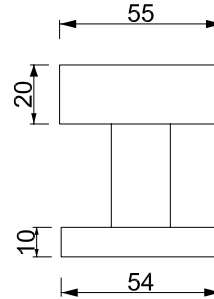
Saten
Satin Nickel

Kod/Code 089448

TEKNİK DETAYLAR / Details

> AISI 30 Paslanmaz Çelik

482 T Serisi

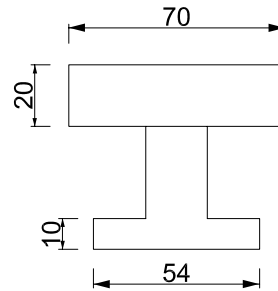
Albrifin
BrassAntik Bronze
Antique BronzeSiyah
Blackİnoks
Inox

TEKNİK DETAYLAR / Details

> AISI 30 Paslanmaz Çelik

Kod/Code 333503

327924

327900

076523