

Alfa Laval C515

Disc stack separator for the dairy industry

Introduction

For more than 130 years, Alfa Laval has been supplying disc stack separators for the dairy industry. Today Alfa Laval has the most complete and diverse offering of separators, each fully optimized for its specific duty.

Alfa Laval's range of disc stack separators has been setting the standards for gentle and efficient separation meeting the strictest hygiene and performance requirements of modern dairies.

Application

Self-cleaning disc stack separators in the C series are specially designed to separate globular milk fat from skimmed milk at low temperatures typically between 4–15 °C . This is possible due to the hermetic design. Under optimal conditions, the cold milk skimming efficiency is achievable down to 0.08 %.

Benefits

- Gentle treatment of the product
- High separation efficiency
- Low power consumption
- Foam-free handling in absence of air
- No oxygen pick-up
- Corrosion resistant
- Designed with focus on CIP
- Easy to operate

Design

The C515 is available in different scopes of supply from a bare separator to a complete separation system.

The unique fully hermetic bottom fed design ensures very gentle treatment of the product and the hermetically sealed inlet and outlet prevent oxygen pick-up. Smooth acceleration of feed in the hollow rotating spindle helps maintain the sizes of the fat globules and other components. The hermetic design not only enhances separation efficiency, but also prevents increase of free fatty acids in the product, which might otherwise result in bad flavour, taste and a shortened shelf life. In addition to these benefits, the hermetic design offers the lowest power consumption in the market.

All parts in contact with the product are in compliance with European food contact material regulation - (EC) No. 1935/2004. The metallic product contact parts are made of



high-grade stainless-steel ensuring corrosion resistance and the non-metallic product contact parts, including gaskets and seals, are made of materials according to FDA requirement. The model is available with certification according to 3-A sanitary standard for Centrifugal Separators and Clarifiers.

Scope of supply

- Disc stack separator
- Cyclone

Options

- Foundation plate
- Set of tools
- Intermediate service kit

Working principle

The milk is continuously fed from the bottom into the rotating separator bowl through the hollow drive spindle. Separation takes place between the bowl discs due to the centrifugal force. The cream moves towards the centre of the bowl and the skimmed milk towards the periphery. The separated liquids are pressurized by the impellers in the outlet housing and thereby working as a centrifugal pump.

Separated sludge is collected in the sediment space and is discharged intermittently via the cyclone. While the sludge is accumulating in the sediment space, the sliding bowl bottom is kept closed against the bowl hood by means of operating water. The sliding bowl bottom lowers, while the machine is operating at full speed, to discharge separated sludge through the discharge ports. The sequential pulses of operating water are used to control the movement of the sliding bowl bottom part that opens and closes the discharge ports.

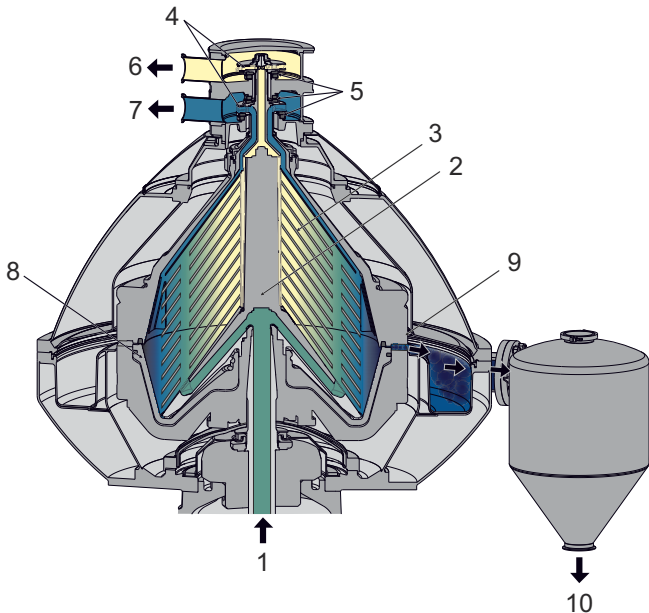

Typical bowl drawing. The details illustrated do not necessarily correspond to the separator described.

1. Inlet
2. Distributor
3. Disc stack
4. Impeller
5. Hermetic seal
6. Light liquid phase outlet
7. Heavy liquid phase outlet
8. Sliding bowl bottom
9. Sludge discharge ports
10. Sludge outlet from cyclone

Technical data

Performance data

Capacity ¹	Max 15 000 l/h (3 900 US gallon/h)
Installed motor power	18.5 kW (25 HP)

¹ Dependent on milk quality and temperature

Main connections

Feed inlet	ISO 2852 (Tri-Clamp) DN63.5
Product outlet (heavy phase)	ISO 2852 (Tri-Clamp) DN51
Product outlet (light phase)	ISO 2852 (Tri-Clamp) DN63.5
Solids outlet	ISO 2852 (Tri-Clamp) DN101

Material data

Bowl body	Duplex Stainless Steel, EN 1.4462, ASTM/UNS S31803
Gaskets (product wetted)	NBR (FDA approved materials)

Weights

Separator incl. bowl and motor	1840 kg (4050 lb)
Bowl	800 kg (1760 lb)

Dimensional drawing

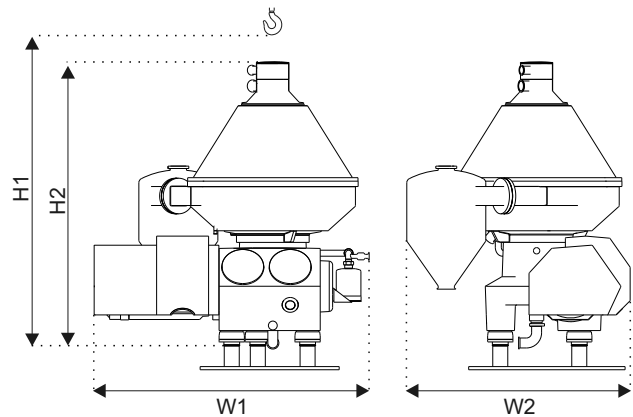

Dimensions

H1 (minimum lifting height)	2 800 mm (9 ft 2 1/4 inches)
H2	1 793 mm (5 ft 10 9/16 inches)
W1	1 742 mm (5 ft 8 9/16 inches)
W2	1 414 mm (4 ft 7 11/16 inches)

This document and its contents are subject to copyrights and other intellectual property rights owned by Alfa Laval Corporate AB. No part of this document may be copied, re-produced or transmitted in any form or by any means, or for any purpose, without Alfa Laval Corporate AB's prior express written permission. Information and services provided in this document are made as a benefit and service to the user, and no representations or warranties are made about the accuracy or suitability of this information and these services for any purpose. All rights are reserved.

How to contact Alfa Laval

Up-to-date Alfa Laval contact details for all countries are always available on our website at www.alfalaval.com