

DW343117

PRESSURE SENSORS • CONNECTION G1/2" OUTER

pressure sensor, Ø38mm 122long, 0-600bar, 12-32V DC, G1/2 inch A, 12-32V DC, 2x PNP NC/NO, 0-10V/4-20mA / 0 ... 20 mA, Plug-in connection M12 4pin, IP65, PA 6.6 (synthetic), With display, Front-flush membrane



MECHANICAL FEATURES

Ambient temperature	-20 °C ... 80 °C
Bursting pressure	2200 bar
Degree of protection (IP)	IP65
Explosion-proof	-
For gaseous media	+
For liquid media	+
For pasty media	+
Front-flush membrane	+
Housing design	Cylinder plain
Housing material	PA 6.6 (synthetic)
Max. operating pressure	900000 hPa
Max. operating pressure	900 bar
Medium temperature	-20 °C ... 80 °C
Nominal pressure	600 bar
Sensing element material	Stainless steel 1.4435
Sensor diameter	38 mm
Sensor length	122 mm
Thread length	12 mm
Thread pitch	1.81 mm
Type of pressure connection	G1/2 inch A
With hand operation	-

ELECTRICAL FEATURES

Adjustable hysteresis	+
Damping (analog output)	20 s ... 20 s
Decay time	5 ms
End setting	480000 hPa ... 600000 hPa
Hysteresis	1 %
Initial setting	0 hPa ... 120000 hPa
Measurement method	Absolute
Measuring range pressure	0 bar ... 600 bar
No-load current	60 mA
Number of pins	4

ELECTRICAL FEATURES

Number of switching outputs	2
Operating voltage	12 V ... 32 V
Peak value memory	+
Programmable via software	+
Rated operating voltage Ue at DC	12 V ... 32 V
Rated switching current	1000 mA
Readiness delay	2000 ms
Relative linearity deviation	0.25 %
Relative repeat accuracy	0.1 %
Response time	5 ms
Reverse polarity protection	+
Setting procedure	Parameterization
Short-circuit protection	+
Suitable as 2-point control	+
Suitable as limiter	+
Suitable as monitor	+
Switching frequency	125 Hz
Switching output with window function	+
Temperature drift	0.2 %
Turn-off delay	20 s
Turn-on delay	20 s
Type of alarm output	PNP
Type of analog output	0 V ... 10 V / 4 mA ... 20 mA / 0 ... 20 mA
Type of electrical connection	Plug-in connection M12
Type of switching function	Normally closed contact/normally open contact
Type of switching output	PNP
Voltage drop	2 V
Voltage type	DC
With display	+
With LED display	+

OTHER FEATURES

For hydraulic applications	+
For pneumatic applications	+
Measuring display	Relative

Other

Packaging dimensions	99.0mm x 60mm x 160mm
Shipping weight	0.39kg
Tariff code	90262020

Classification

ipf product group	360
eClass 8.0	27371814
eClass 9.0	27371814
eClass 9.1	27371814
ETIM-5.0	EC000243
ETIM-6.0	EC000243
ETIM-7.0	EC000243

Connection

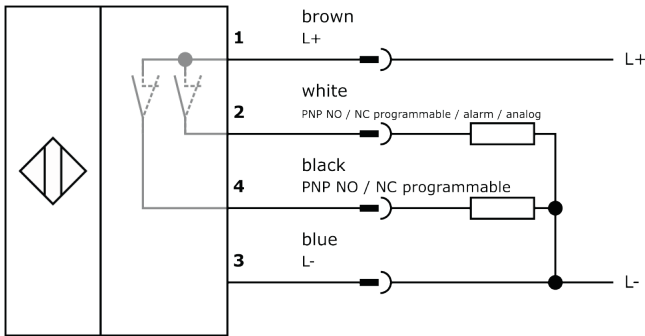

Dimensional drawing

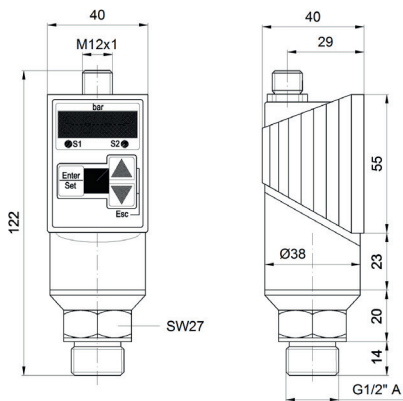

Installation



Mounting / installation may only be carried out by a qualified electrician!

Disposal



Software

Any software, drivers or IODD files that may be required to operate your device can be downloaded free of charge from our homepage: www.ipf-electronic.com

Safety warnings

Before initial operation, please make sure to follow all safety instructions that may be provided in the product information.

Never use these devices in applications where the safety of a person depends on their functionality.

LED lighting systems can generate intensive UV radiation, which can damage your eyes in case of improper use. The manufacturer cannot be held responsible for damages that result from improper use or connection.