

OC538121

CAMERA SENSORS • CAMERA SENSORS

Camera sensors are used to simultaneously check various properties of objects (e.g., completeness, dimensional accuracy, position, damages, labeling). This takes place independent of the component position virtually in real time. Camera sensors are image processing systems that combine image sensor and image processing computer with image processing software in a metal housing. Depending on the version, lens and illumination unit are also integrated in the housing or must be additionally mounted. The camera sensors are set using an intuitive software program. On the device, object-specific check programs can be stored that contain the respective feature checks. These programs can be activated depending on the object that is to be inspected. The rugged housing design makes possible use under harsh environmental conditions.



MECHANICAL FEATURES

Ambient temperature	5 °C ... 50 °C
Degree of protection (IP)	IP67
Housing coating	With powder coating
Housing material	Aluminum
Material of optical surface	PMMA
Sensor height	113 mm
Sensor length	38 mm
Sensor width	53 mm

ELECTRICAL FEATURES

Error image memory	32
Feature comparison, color arrangement	-
Feature comparison, color determination	-
For interchangeable lens (C-mount)	-
Input voltage at DC	8 V ... 30 V
Integrated flash controller for external illumination	-
Max. output current	100 mA
Measuring time for high speed	100 fps
No-load current	208 mA
Number of digital inputs	5
Number of digital outputs	5
Number of pins	12
Number of pins of the communication interface	4
Number of switching outputs	5
Operating voltage	18 V ... 30 V
Power consumption	5 W
Property picture system	Infrared
QR code and barcode identification	-
Reverse polarity protection	+
Setting procedure	Application software
Short-circuit protection	+
Type of communication interface	Connector M12
Type of electrical connection	M12-connector

ELECTRICAL FEATURES

Type of plug-in contact, communication interface	Female (socket)
Type of switching function	Programmable/configurable
Type of switching output	PNP
With communication interface, Ethernet	+
With communication interface, RS-232	-
With communication interface, RS-485	-
With Ethernet/IP	+
With Profinet	-
With RS485	-

OPTICAL FEATURES

Resolution	752x480
Light source	Infrared light
Focal distance	16mm
Image recorder	CMOS(1/3")
Minimum distance	70 mm
Measuring time for high resolution	50 fps
Testing and sorting	+
Dimensional accuracy	+
Text identification (OCR)	-
Pick and place	-
Object evaluation regardless of position	+
Part location on contours	+
Part location on edges	-
Part location on circle	-
Part location on text line	-
Geometry - distance	+
Geometry - circle	+
Geometry - angle	+
Geometry - count edges	-
Geometry - point position	-
Feature comparison, count contour points	+
Feature comparison, contour comparison	+
Feature comparison, brightness	+
Feature comparison, contrast	-
Feature comparison, area size	-
Feature comparison, count areas	-
Feature comparison, pattern comparison	-
Geometry of edge contour	+

OTHER FEATURES

Air humidity	0 ... 90% noncondensing
Risk groups	0
Shock resistance in acc. with EN 60068-2-27	+
Vibration resistance in acc. with IEC 60068-2-6 / IEC 60068-2-64	+

Other

Packaging dimensions	140mm x 150mm x 200mm
Shipping weight	0.43kg
Tariff code	90314990

Classification

ipf product group	715
eClass 8.0	27310201
eClass 9.0	27310201
eClass 9.1	27310201
ETIM-5.0	EC001511
ETIM-6.0	EC001511
ETIM-7.0	EC001511

Connection

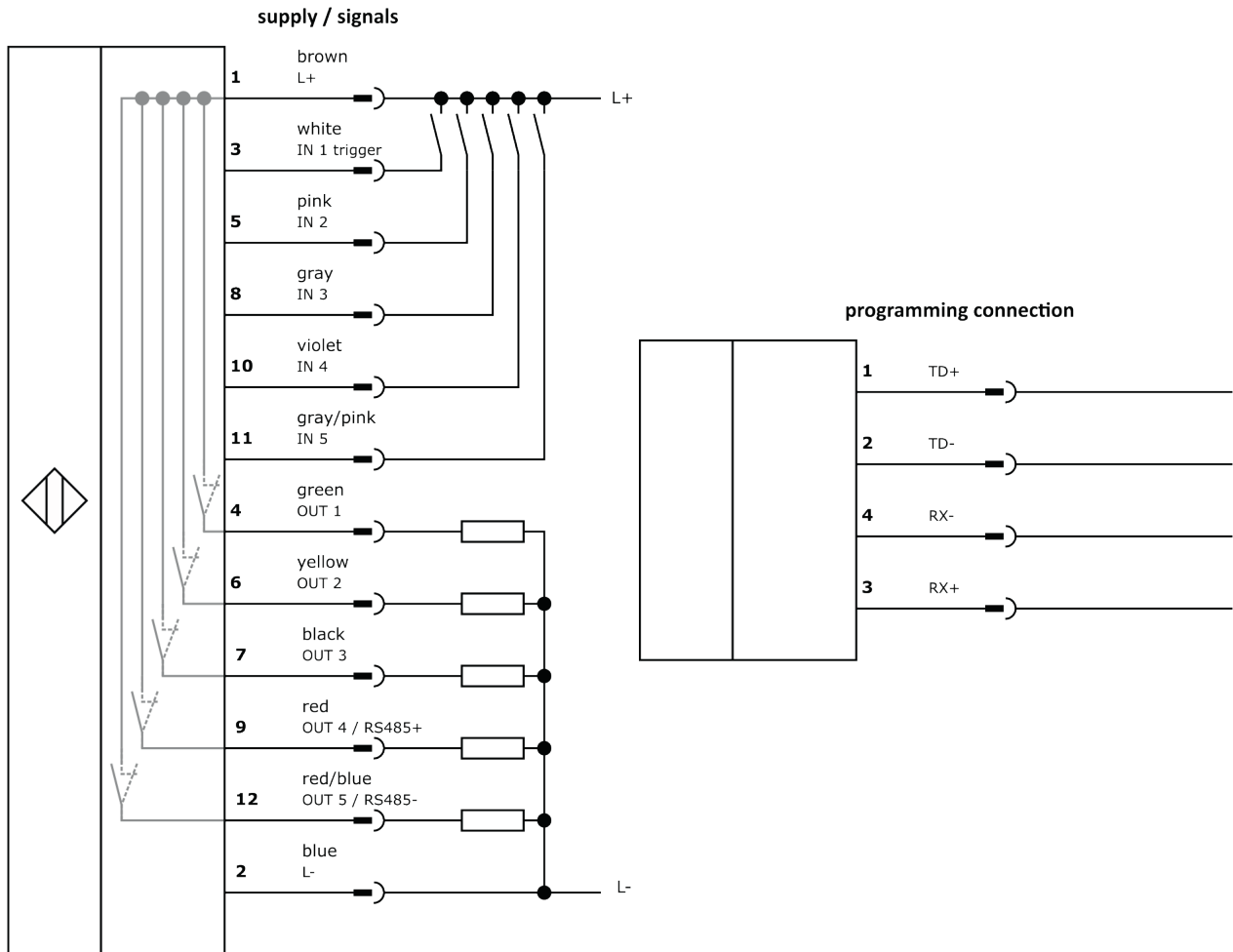

Dimensional drawing

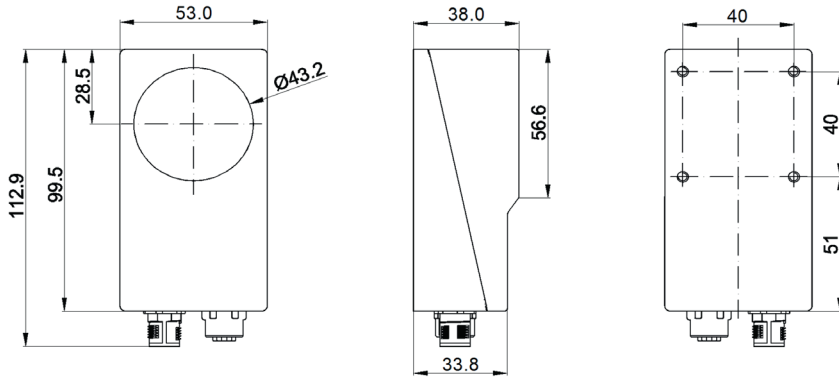

Installation



Mounting / installation may only be carried out by a qualified electrician!

Disposal



Software

Please download the software or driver required for operating your new device on our homepage: www.ipf.de

Safety warnings

Before initial operation, please make sure to follow all safety instructions that may be provided in the product information. Never use these devices in applications where the safety of a person depends on their functionality. LED lighting systems can generate intensive UV radiation, which can damage your eyes in case of improper use. The manufacturer cannot be held responsible for damages that result from improper use or connection.