

SS400120

FLOW SENSORS • SENSORS FOR WATER

sensor flow, Calorimetric, Ø40mm 73long, G1/4 inch, 24V DC, PNP NO (NO), Plug-in connection M12 4pin, V4A, Pressure resistance 100bar, Manual adjustment



MECHANICAL FEATURES

Degree of protection (IP) of evaluation electronics	IP67
Degree of protection (IP) of measuring head	IP67
Depth	73 mm
Design	Cylinder plain
Housing material	Stainless steel 1.4571
Length	73 mm
Measuring range of flow velocity with oil (MAX)	3 m/s
Measuring range of flow velocity with oil	0.03 m/s ... 1.5 m/s
Measuring range of flow velocity with water	0.01 m/s ... 80 °C
Pressure resistance	100 bar
Sensing element material	Stainless steel 1.4571
Sensor diameter	40 mm
Thread length	25 mm
Type of process connection	G1/4 inch

ELECTRICAL FEATURES

Adjustable responding value for flow for liquids	0.01 m/s ... 3 m/s
Measuring principle of flow	Calorimetric
No-load current	70 mA
Number of pins	4
Operating voltage	24 V ... 24 V
Pressure resistance of measuring head	100 bar
Rated switching current	400 mA
Readiness delay	15 ms
Residual ripple	20 %
Reverse polarity protection	+
Setting procedure	Manual adjustment
Short-circuit protection	+
Type of electrical connection	Plug-in connection M12
Type of switching function	Normally open contact (NO)
Type of switching output	PNP
Voltage drop	2 V
Voltage type	DC

ELECTRICAL FEATURES

With LED display +

OTHER FEATURES

Cooling water circuits	+
For hydraulic applications	+
Suitable for gases	-
Suitable for liquids	+

Other

Packaging dimensions	99.0mm x 60mm x 160mm
Shipping weight	0.32kg
Tariff code	90261021

Classification

ipf product group	300
eClass 8.0	27371815
eClass 9.0	27371815
eClass 9.1	27371815
ETIM-5.0	EC002580
ETIM-6.0	EC002580
ETIM-7.0	EC002580

Connection

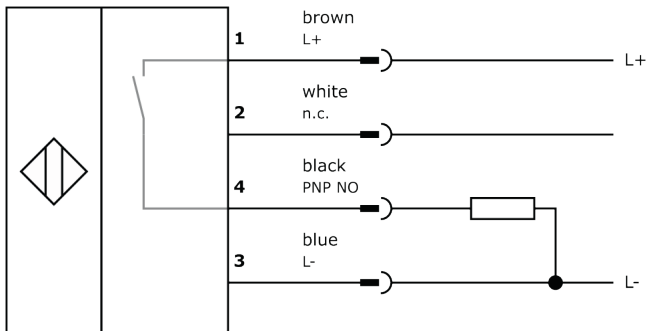

Dimensional drawing

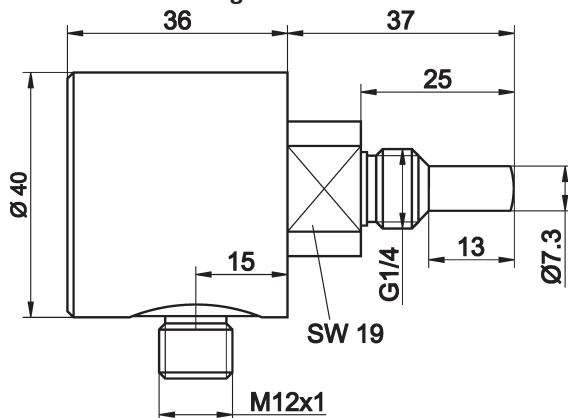

Installation



Mounting / installation may only be carried out by a qualified electrician!

Disposal



Software

Any software, drivers or IODD files that may be required to operate your device can be downloaded free of charge from our homepage: www.ipf-electronic.com

Safety warnings

Before initial operation, please make sure to follow all safety instructions that may be provided in the product information.

Never use these devices in applications where the safety of a person depends on their functionality.

LED lighting systems can generate intensive UV radiation, which can damage your eyes in case of improper use. The manufacturer cannot be held responsible for damages that result from improper use or connection.