

SS906024

FLOW SENSORS • SENSORS FOR WATER

sensor flow, Calorimetric, G1/2 inch, Anschluss an Verstärker, Plug-in connection M12 4pin, V4A, Pressure resistance 100bar

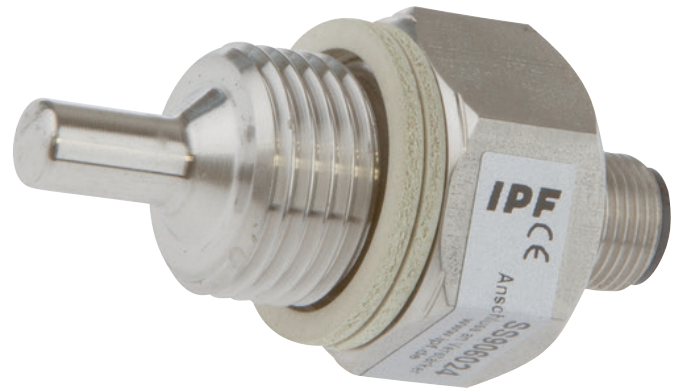

MECHANICAL FEATURES

Degree of protection (IP) of evaluation electronics	IP67
Degree of protection (IP) of measuring head	IP67
Design	Cylinder, screw-thread
Housing material	Stainless steel (V4A)
Measuring range of flow velocity with oil	0.03 m/s ... 3 m/s
Measuring range of flow velocity with water	0.01 m/s ... 1.5 m/s
Pressure resistance	100 bar
Sensing element material	Stainless steel 1.4571
Thread length	31 mm
Type of process connection	G1/2 inch

ELECTRICAL FEATURES

Adjustable responding value for flow for liquids	0.01 m/s ... 3 m/s
Connection to amplifier	+
Max. line length	100 m
Measuring principle of flow	Calorimetric
Number of pins	4
Pressure resistance of measuring head	100 bar
Readiness delay	15 ms
Response time	13000 ms
Temperature setting	20 °C ... 100 °C
Turn-off delay	25 s
Type of electrical connection	Plug-in connection M12

OTHER FEATURES

Cooling water circuits	+
For hydraulic applications	+
Suitable for gases	-
Suitable for liquids	+

Other

Packaging dimensions	43.0mm x 43.0mm x 105.0mm
Shipping weight	0.11kg
Tariff code	90261021

Classification

ipf product group	300
eClass 8.0	27371815
eClass 9.0	27371815
eClass 9.1	27371815
ETIM-5.0	EC002580
ETIM-6.0	EC002580
ETIM-7.0	EC002580

Connection

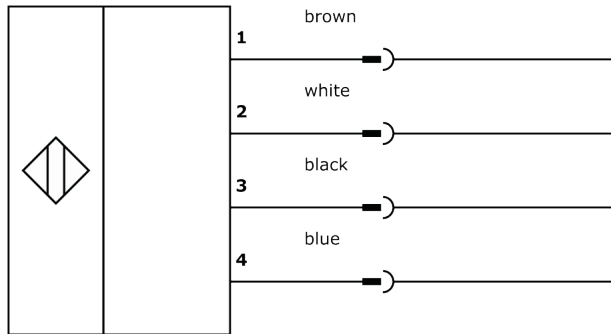

Dimensional drawing

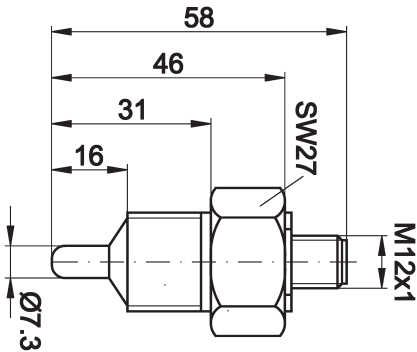

Installation



Mounting / installation may only be carried out by a qualified electrician!

Disposal



Software

Any software, drivers or IODD files that may be required to operate your device can be downloaded free of charge from our homepage: www.ipf-electronic.com

Safety warnings

Before initial operation, please make sure to follow all safety instructions that may be provided in the product information. Never use these devices in applications where the safety of a person depends on their functionality. LED lighting systems can generate intensive UV radiation, which can damage your eyes in case of improper use. The manufacturer cannot be held responsible for damages that result from improper use or connection.