

MONOBLOCK DIRECTIONAL CONTROL VALVES

T08-5006201000 - AMV501 50L/MIN – 1 SPOOL , DOUBLE ACTING - 1/2" BSP

Nominal Flow	50 lpm
Number of Spools	1
Maximum Working Pressure	350 bar
Spool Positioner & type	3 position, double acting, spring return with lever cap
Main Relief Valve	Pre-set to 180 bar
T2, T(CO) Threads	1/2" BSP
P,P1,T1,A&B Threads	1/2" BSP
Maximum Back Pressure	30 bar
Internal Leakage	4 cc – 9 cc (100 Bar; 32 cSt, 40°C)
Recommended Oil Viscosity Range	10 cSt to 75 cSt
Recommended Fluid Temperature Range	-20 to +80
Environmental Temperature	-40 to +60
Maximum Contamination Level	Class 9 (NAS 1638) 19/16 (ISO 4406)

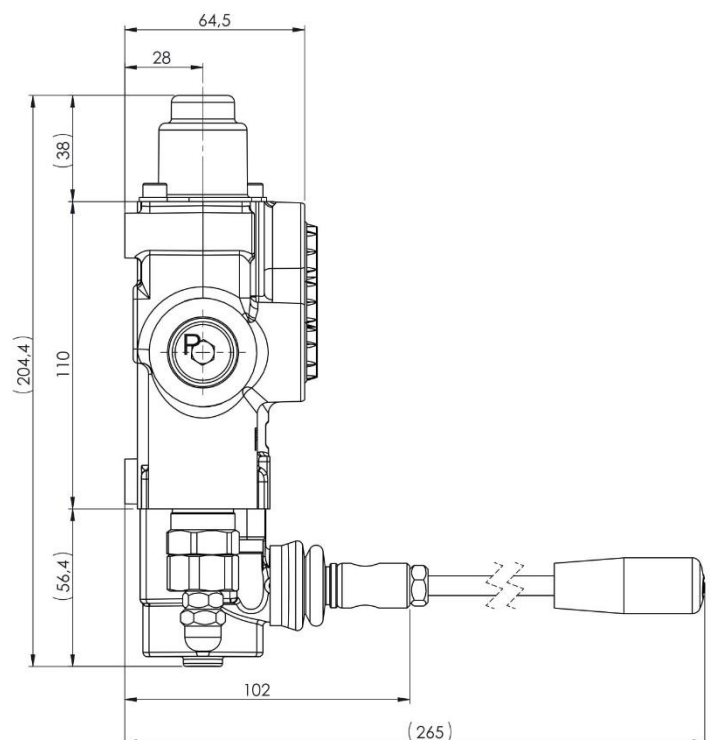
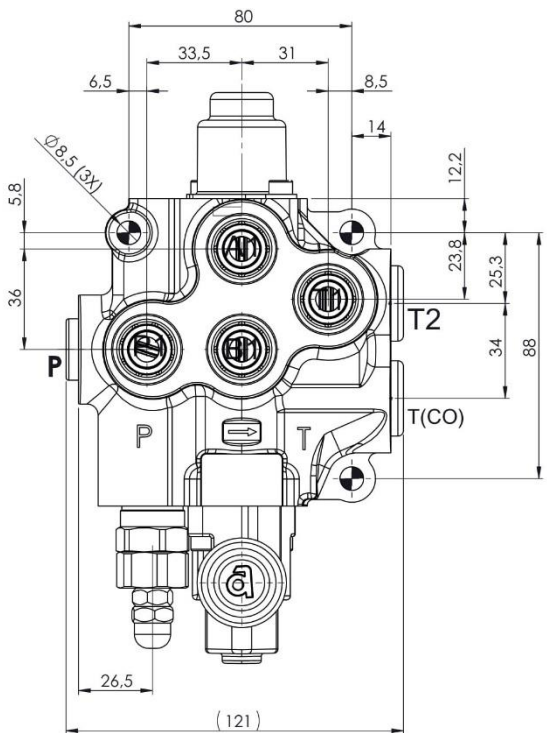

MONOBLOCK DIRECTIONAL CONTROL VALVES

T08-5006201000 - AMV501 50L/MIN – 1 SPOOL , DOUBLE ACTING - 1/2" BSP

