

HYDRAULIC RETURN FILTERS

TANK MOUNTED RETURN FILTER 1" - 25 MICRON – 260LT.

Construction	Aluminium head casting, Steel Bowl (05 series Nylon 66.)
Seals	Nitril
Max. Working Pressure	10 bar
Operating Temperature	-10°C~ +100°C
Bypass Crack Pressure	1,5bar ± 0,3 bar
Port Size	G 1"
Filtration	25μ
Flows	260lt/min.
Suitable Element	T12-3-3-0051 / FILTER ELEMENTS_25M_260L

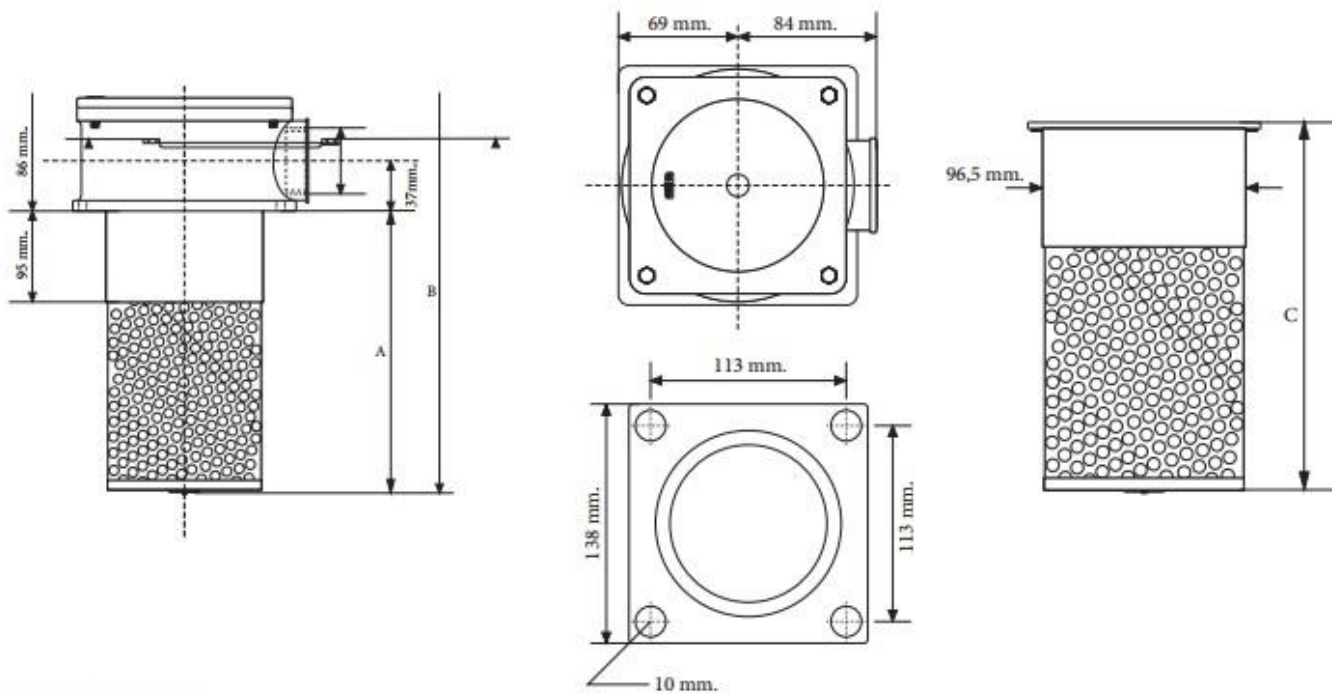

DIMENSIONS

PRODUCT NUMBER	FLOW (Δp 0,25)lt/dk.	G	A	B	C	REPLECEMENT ELEMENT	FILTER MEDIA	FILTER AREA cm ²
T12-3-3-0041	260	1"	235	321	250	T12-3-3-0051	25μ	3900