

HYDRAULIC RETURN FILTERS

TANK MOUNTED RETURN FILTER 1" - 60 MICRON – 340LT.

Construction	Aluminium head casting, Steel Bowl (05 series Nylon 66.)
Seals	Nitril
Max. Working Pressure	10 bar
Operating Temperature	-10°C~ +100°C
Bypass Crack Pressure	1,5bar ± 0,3 bar
Port Size	G 1"
Filtration	60μ
Flows	340lt/min.
Suitable Element	T12-3-3-0052 / FILTER ELEMENTS_60M_340L

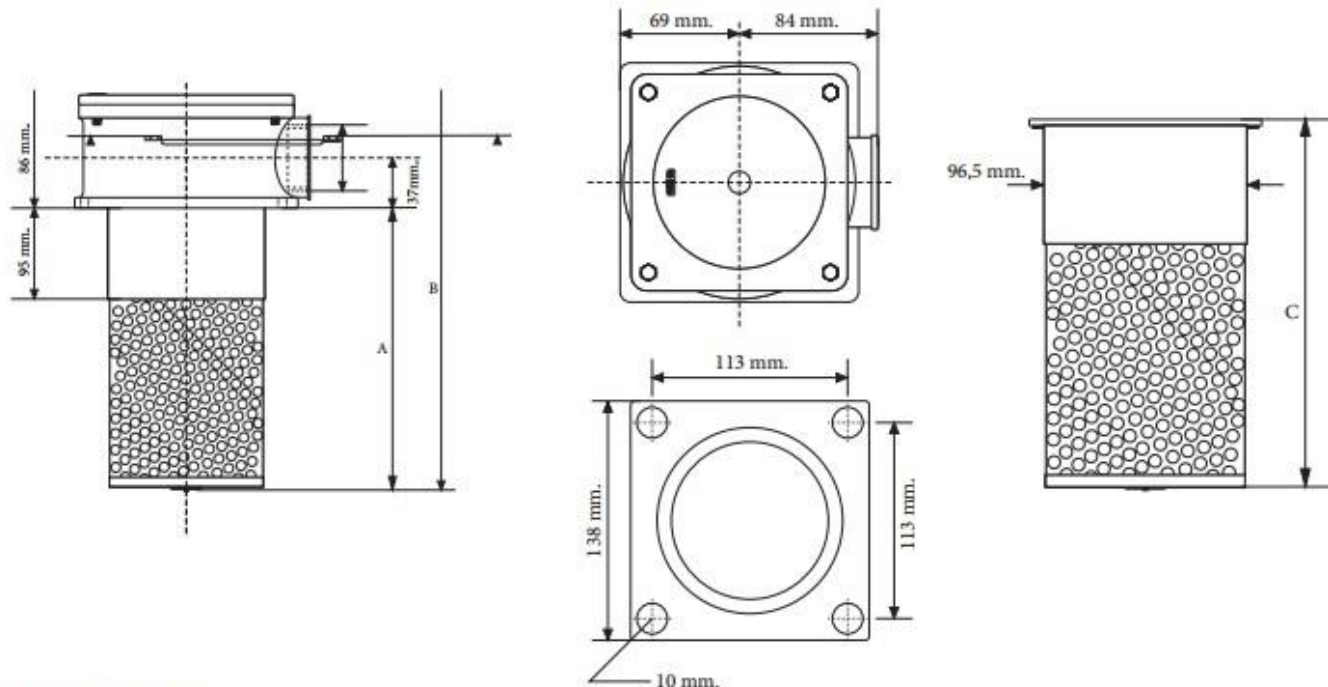

DIMENSIONS

PRODUCT NUMBER	FLOW (Δp 0,25)lt/dk.	G	A	B	C	REPLECEMENT ELEMENT	FILTER MEDIA	FILTER AREA cm ²
T12-3-3-0042	340	1"	235	321	250	T12-3-3-0052	60μ	2250