

HYDRAULIC RETURN FILTERS

TANK MOUNTED RETURN FILTER 3/4" - 10 MICRON - 65LT.

Construction	Aluminium head casting, Steel Bowl (05 series Nylon 66.)
Seals	Nitril
Max. Working Pressure	10 bar
Operating Temperature	-10°C~ +100°C
Bypass Crack Pressure	1,5bar ± 0,3 bar
Port Size	G 3/4"
Filtration	10μ
Flows	65lt/min.
Suitable Element	T12-3-3-0113 / FILTER ELEMENTS_10M_65L

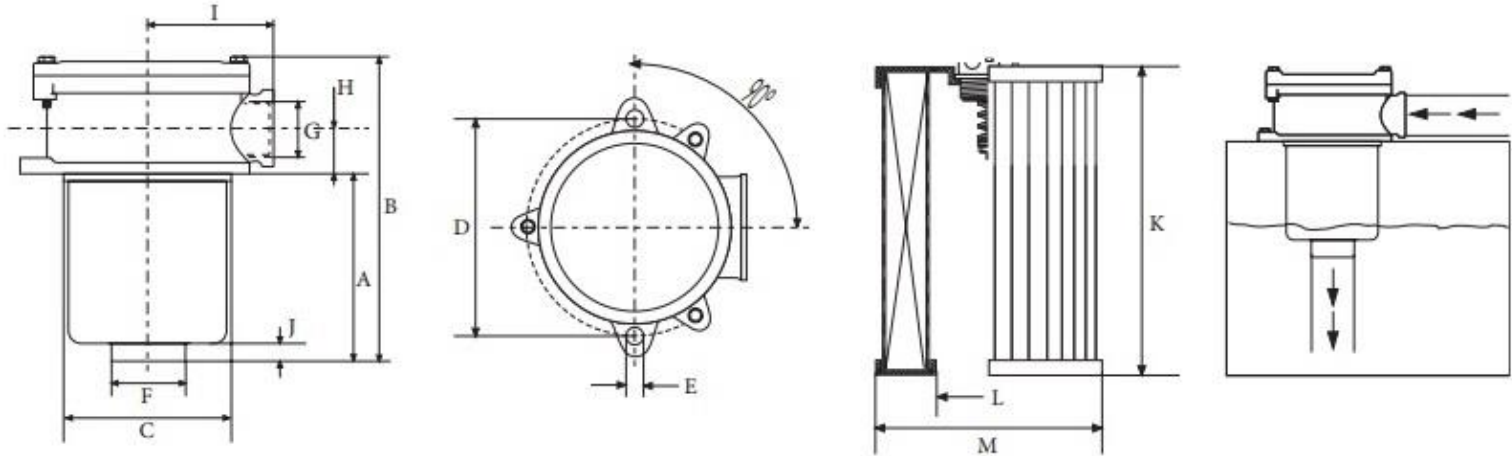

DIMENSIONS

PRODUCT NUMBER	FLOW (Δp 0,25)lt/dk.	G	A	B	C	D	E	F	H	I	J	REPLECEMENT ELEMENT	FILTER MEDIA	K	L	M	FILTER AREA cm ²
T12-3-3-0109	65	3/4"	103	172	87	115	9	1"	30	66	11	T12-3-3-0113	10μ	100	29	71	1320