

ORION 12V/7.2Ah F1 AGM BATTERY

AGM BATTERIES



AGM (Absorbent Glass Mat) technology, high performance plates, and electrolyte are employed in the General Series Valve Regulated Lead Acid batteries' design to increase power output for common power backup system applications, which are frequently used in the UPS and Emergency Lighting System industries.



Features

- Sealed and conservation free operation.
- Non-Spillable construction design.
- ABS holders and covers optional.
- Safety stopcock installation for explosion evidence.
- High quality and high trustability.
- Exceptional deep discharge recovery performance.
- Low tone discharge specific.
- Inflexibility design for multiple install positions.

Applications

- Toys
- Home Appliances
- Consumer Electronics
- Alarm System
- UPS
- Medical Equipment
- Security System
- Power Tools
- Cable Television
- Solar

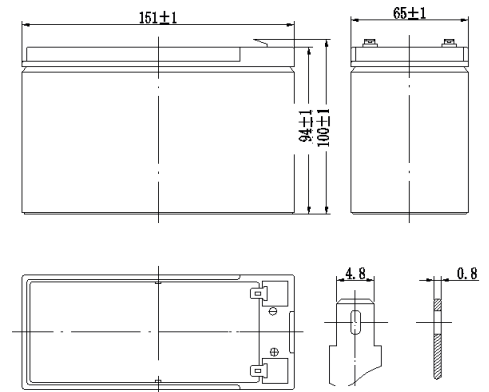

Technical Specification

Battery model	ORN-1272			
Designed Floating Life	3~5 Years			
Capacity (25°C)	20hR(0.36A, 10.5V)	10hR(0.716A, 10.5V)	5hR(1.31A, 10.5V)	1hR(5.21A, 9.60V)
	7.2Ah	7.16Ah	6.55Ah	5.21Ah
Dimensions	Length	Width	Height	Total Height
	151±1mm	65±1mm	94±1mm	100±1mm
Approx. weight (±5%)	2.1Kg			
Internal resistance	Full charged at 25°C: Approx. 25mOhms			
Self discharge	3% of capacity declined per month at 25°C (average)			
Capacity Affected by Temp.(20HR)	40 °C	25 °C	0 °C	-15 °C
	102%	100%	85%	65%
Charge Voltage (25°C)	Cycle use		Float use	
	14.4-15.0V(-15mV/°C), max. Current: 2.16A		13.5-13.8V(-10mV/°C)	



0(212) 320 99 84



pilsanelektronik.com.tr
info@pilsanelektronik.com



Pilsan Plaza, Esenkent Mah.
Erzincan Cad. No:22
Dudullu OSB Ümraniye / İstanbul

Construction

Component	Positive plate	Negative plate	Container	Cover	Safety valve	Terminal	Separator	Electrolyte
Raw material	Lead dioxide	Lead	ABS	ABS	Rubber	Lead	Fiberglass	Sulfuric acid

Charge / Discharge Curve

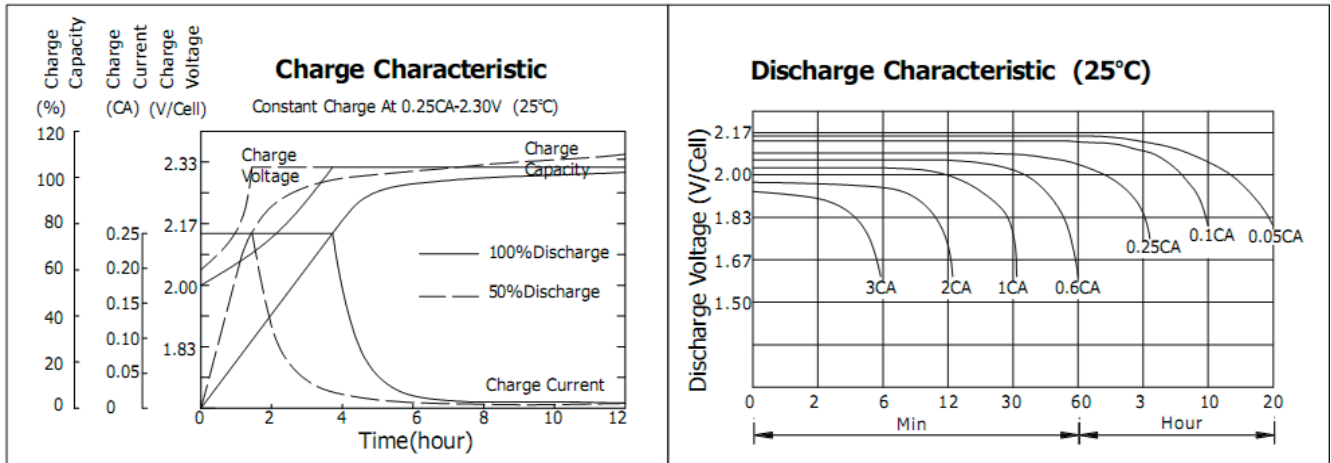

SoC & Cycle Life

