

# DURACELL®

DURALOCK  
POWER PRESERVE™



## ULTRA POWER

# MX1500

## Size: AA (LR6)

### Alkaline-Manganese Dioxide Battery

Zn/MnO<sub>2</sub>



|                             |  |
|-----------------------------|--|
| Nominal voltage             | 1.5 V                                      |
| Impedance                   | 81 m-ohm @ 1 kHz                           |
| Typical weight              | 24 g (0.8 oz)                              |
| Typical volume              | 8.4 cm <sup>3</sup> (0.5 in <sup>3</sup> ) |
| Terminals                   | Flat                                       |
| Storage temperature range   | 5°C to 30°C (41°F to 86°F)                 |
| Operating temperature range | -20°C to 54°C (-4°F to 130°F)              |
| Designation                 | IEC: LR6                                   |

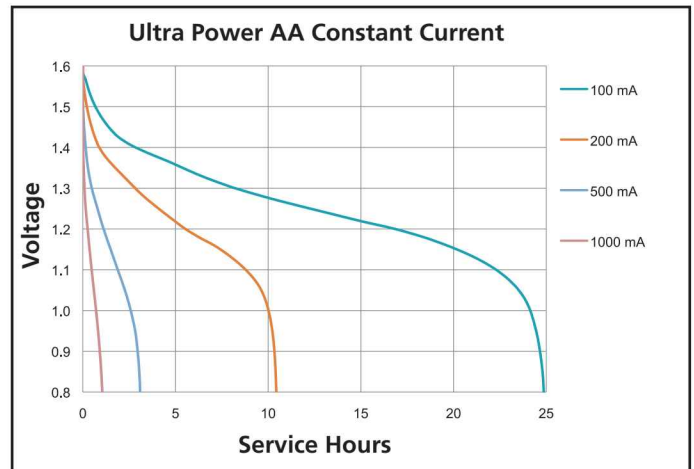
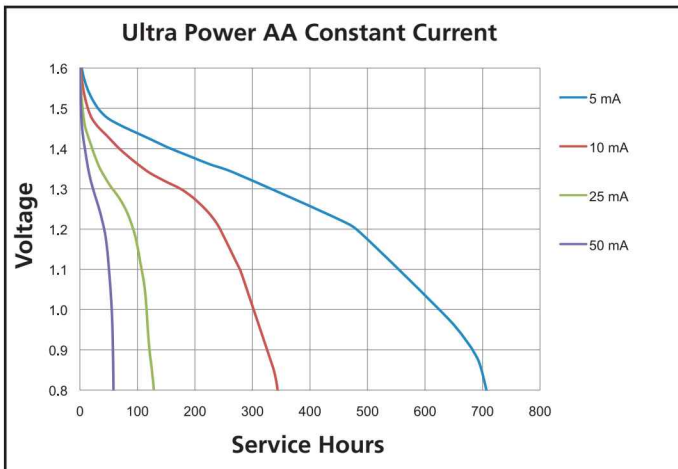
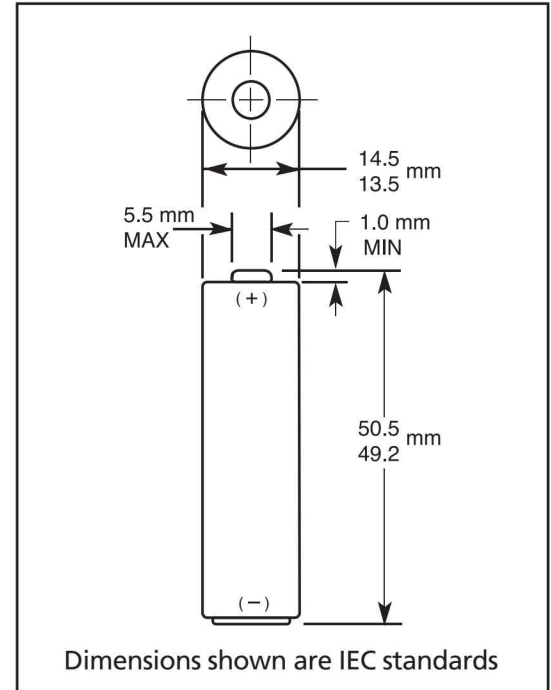

# DURACELL®

BATTERIES

Berkshire Corporate Park  
Bethel, CT. 06801 U.S.A.  
Telephone: Toll-free 1-800-544-5454  
www.duracell.com

Delivered capacity is dependent on the applied load, operating temperature and cut-off voltage. Please refer to the charts and discharge data shown for examples of the energy/service life that the battery will provide for various load conditions.

# DURACELL®

DURALOCK  
POWER PRESERVE™



## ULTRA POWER

# MX1500

## Size: AA (LR6)

Alkaline-Manganese Dioxide Battery

Zn/MnO<sub>2</sub>

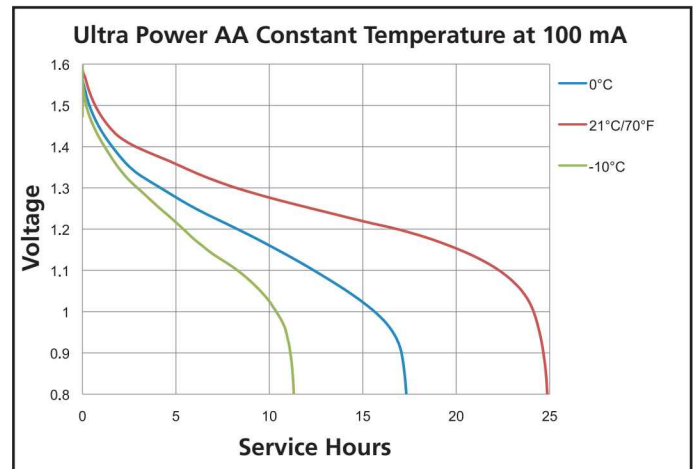
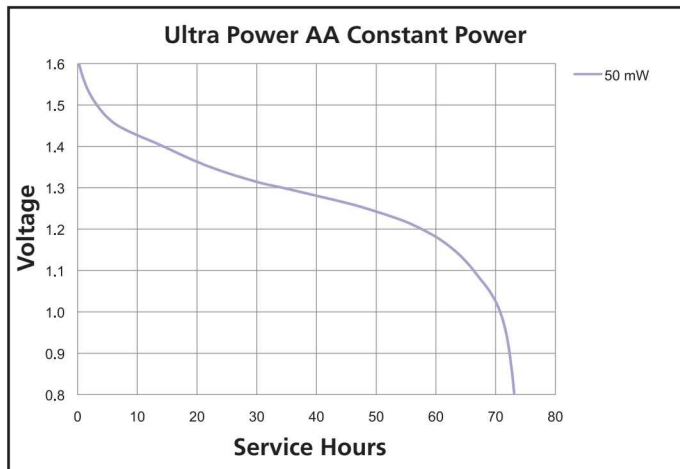
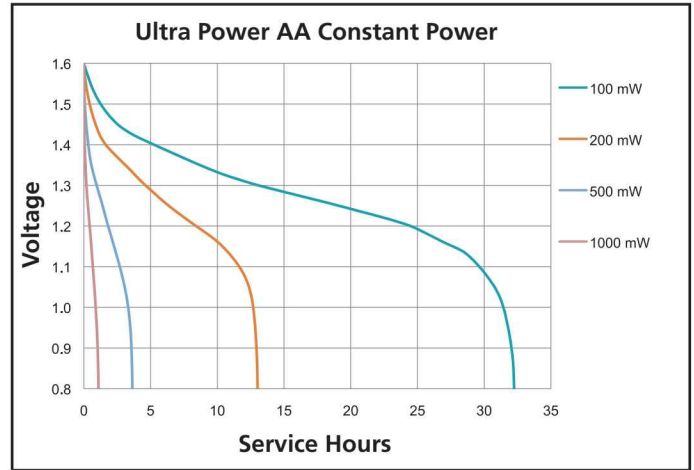
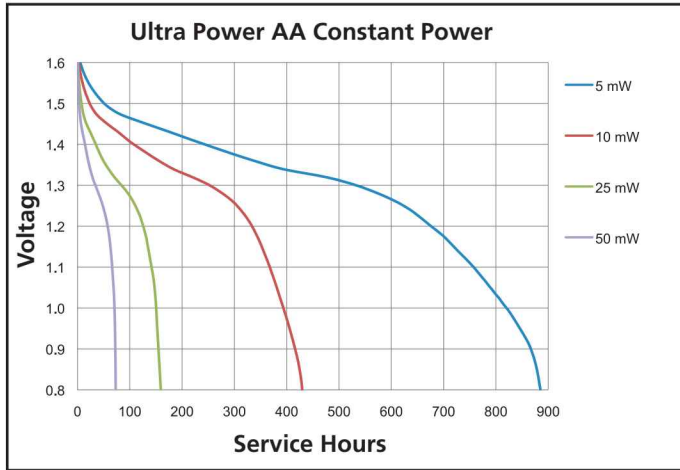

Delivered capacity is dependent on the applied load, operating temperature and cut-off voltage. Please refer to the charts and discharge data shown for examples of the energy/service life that the battery will provide for various load conditions.

# DURACELL®

BATTERIES

Berkshire Corporate Park  
Bethel, CT. 06801 U.S.A.  
Telephone: Toll-free 1-800-544-5454  
www.duracell.com

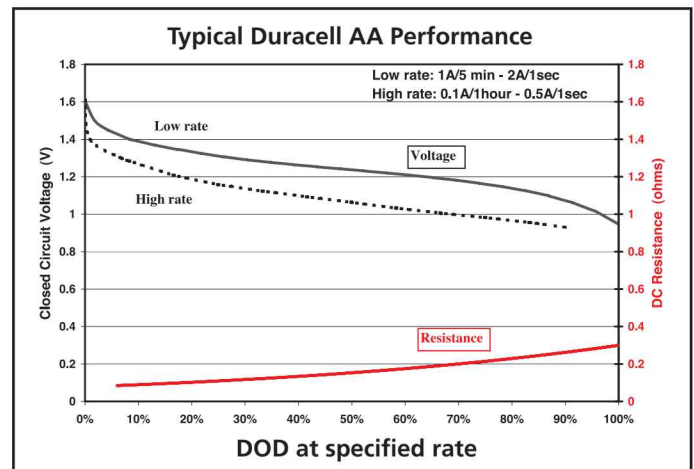

This data is subject to change. Performance information is typical. Contact Duracell for the latest information.

**MX15UPWE0614**