

[Skip to content](#)

Manuals+

User Manuals Simplified.



EBL TB-6409 LCD Rechargeable Smart Quick Universal Charger User Manual

[May 10, 2022](#) [May 11, 2022](#) [Leave a comment on EBL TB-6409 LCD Rechargeable Smart Quick Universal Charger User Manual](#)

[Home](#) » [EBL](#) » EBL TB-6409 LCD Rechargeable Smart Quick Universal Charger User Manual 

EBL[®]

Professional Care on Batteries and Charger!

User Manual

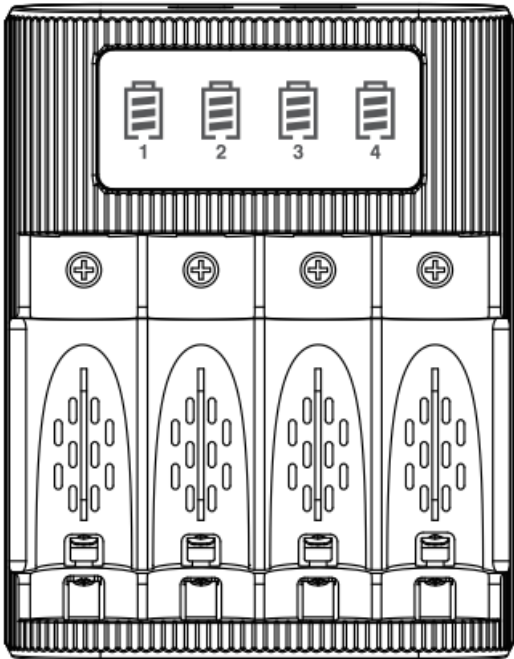

Thanks for purchasing EBL's products!
For your own safety, please read this user manual carefully before using it.

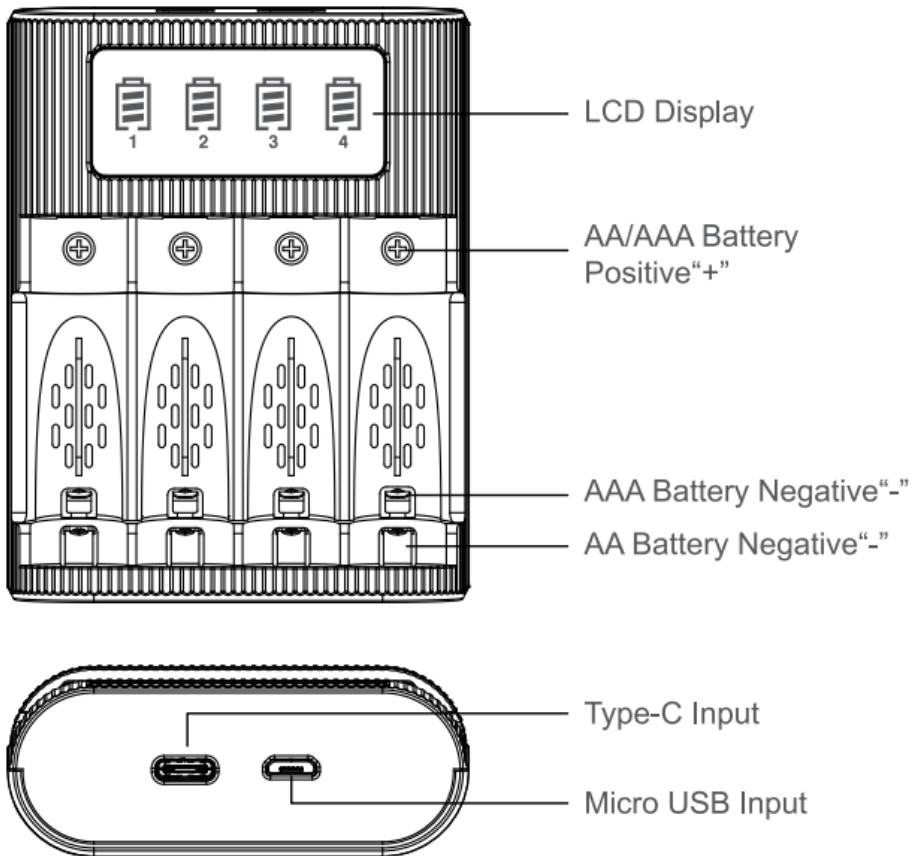

Contents [hide](#)

[1 Specifications](#)

[2 Features](#)

[3 Working Environment Condition](#)

[4 How to Use](#)

[5 Important Safety Instructions](#)

[6 Size & Weight](#)

[7 Warranty](#)

Specifications

Input: DC 5V/2A

Output Voltage: DC 1.4V

Output Current: 500 mA

No-load Power Consumption: 0.3 W(Max)

Battery Charging Rate: -72;90%

Features





1. The charger is compatible with 1/2/3/4 AA/AAA Ni-MH Ni-CD rechargeable batteries.
2. Smart charger with quick technology, charging speed up to 500mA, effectively charging batteries, save your time.
3. With an advanced MCU control system, and an intelligent AV and -AV cut-off charging method, the charger turns to trickle charging automatically to prevent the batteries from over-voltage, over-current, and over-heat.
4. With an LCD screen to show the charging process, battery status can be easily monitored.
5. Powered by a Micro USB or Type C input port, USB charging allows you to try more charging methods, such as charging with a power bank, 5V 2A power adapter.
6. If the battery voltage is between 0.4-0.9v, the charger will renovate it automatically.

Working Environment Condition

- Storage Temperature: -5 C- 40 C
Storage Humidity: 45% – 85%
- Working Temperature: 0 C- 35 C
Working Humidity: 35% – 95%
- Surface Temperature in Charging:
Surface Temperature of Charger: 35 C -60 C
Surface Temperature of Battery: 25 C- 60 C

How to Use

1. Plug in the Micro USB/Type C cable and power on LCD screens light up and show every character on screen first, then the character disappears.
2. Make sure the battery is placed correctly so that the “+/-” pole of the battery corresponds to the “+/-” of the charger.
3. Charging status: Independently show the charging status of each battery in the form of a battery icon.
4. If the charging is abnormal (the positive and negative poles are placed conversely; the battery is broken), the corresponding icon will flash.

Charging status			Abnormal charging
 ≅ 33% flashing	 ≅ 66% flashing	 100% fully charged	 keeping flashing

Notices

1. The charger is ONLY designed for AA/AAA Ni-MH Ni-CD rechargeable batteries. Please DO NOT put any other types of batteries in this charger, especially alkaline batteries.
2. Please use the power cable provided by EBL. Recommended charging the battery with a 5V/2A power adapter.
3. Place the batteries into the charger correctly by making sure the +/- pole of the battery matches the +/- pole of

the charger.

4. The charger can charge each battery independently.
5. When non-rechargeable batteries are put in, or there's short-circuit situation, the whole LCD screen will flash all the time.
6. The new battery will reach the best performance after using 2-3
7. Battery power will lose because of long-time storage. Please charge the battery fully if it is not used for a long time.
8. It's normal that the battery becomes hot while charging. The temperature will cool down to normal later, please feel free to use
9. Please note that Micro USB and Type C input ports can not be simultaneously powered on.

Important Safety Instructions

1. Turn off the charger and take the batteries out after charging is
2. DO NOT disassemble and reassemble the charger, or it may cause short-circuit.
3. DO NOT charge batteries whose covers are damaged, or it may cause a short circuit and fire hazard.
4. DO NOT charge non-rechargeable batteries. It might cause battery leakage, battery explosion, personal injuries, etc.
5. DO NOT put anything on the charger while charging batteries, it will accumulate heat to cause a fire hazard.
6. Indoor use only, keep it away from direct sunlight and moist/high-temperature environment.
7. Children should not use this charger without any adult's
8. Store this charger out of reach of children.

Size & Weight

Size: 89mm x 69mm x 28mm

Weight: 66.4g

Warranty

- We provide 30 days of worry-free money back and a one-year limited warranty.
- Any problems, please feel free to contact us: service@ebmail.com
- Website: ebmall.com

Documents / Resources



[EBL TB-6409 LCD Rechargeable Smart Quick Universal Charger](#) [pdf] User Manual

TB-6409, LCD Rechargeable Smart Quick Universal Charger

Related Manuals / Resources



[EBL 992 Smart Rapid Battery Charger User Manual](#)

EBL 992 Smart Rapid Battery Charger User Manual General Information
Detailed instruction is provided in this manual (...)

[EBL LN-6426 12-Socket Battery Charger with LCD Display User Manual](#)

EBL LN-6426 12-Socket Battery Charger with LCD Display User Manual General Information Preface: This manual will introduce the...

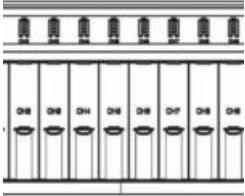

[SMART TECHNOLOGY Spektrum Smart Charger Instruction Manual](#)

SMART Spektrum Smart Charger Instruction Manual Spektrum Smart Charger Update instructions, Download Links and Change Log 15 ...



[Decora Smart WiFi App Quick Guide](#)

Decora Smart™ Wi-Fi App Quick Guide Download the App The My Leviton app is available on Google Play...

Leave a comment

Your email address will not be published.

Comment

Name

Email

Website

Save my name, email, and website in this browser for the next time I comment.

[Manuals+](#),

- [home](#)
- [privacy](#)