

INDUSTRIAL
BY DURACELL®

ID1300

Size: D (LR20)

Alkaline-Manganese Dioxide Battery

Zn/MnO₂

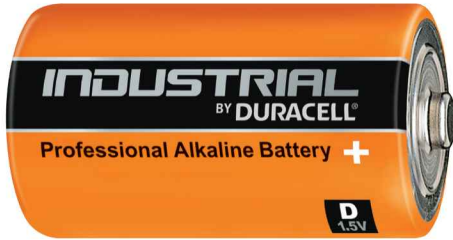

Nominal voltage	1.5 V
Impedance	136 m-ohm @ 1 kHz
Typical weight	139 g (4.9 oz)
Typical volume	56.4 cm ³ (3.4 in ³)
Terminals	Flat
Storage temperature range	5°C to 30°C (41°F to 86°F)
Operating temperature range	-20°C to 54°C (-4°F to 130°F)
Designation	IEC: LR20

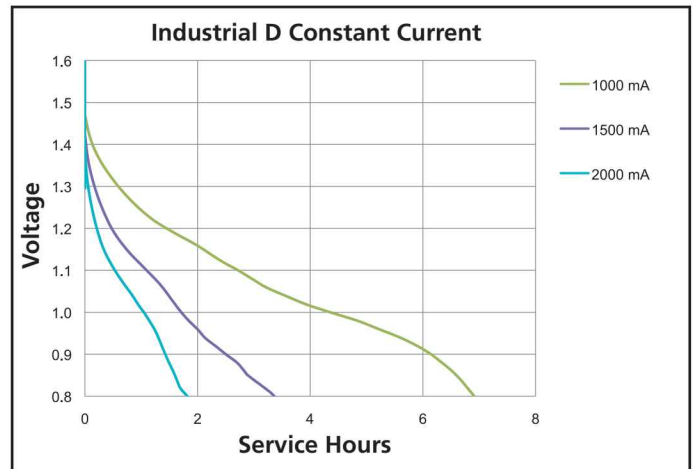
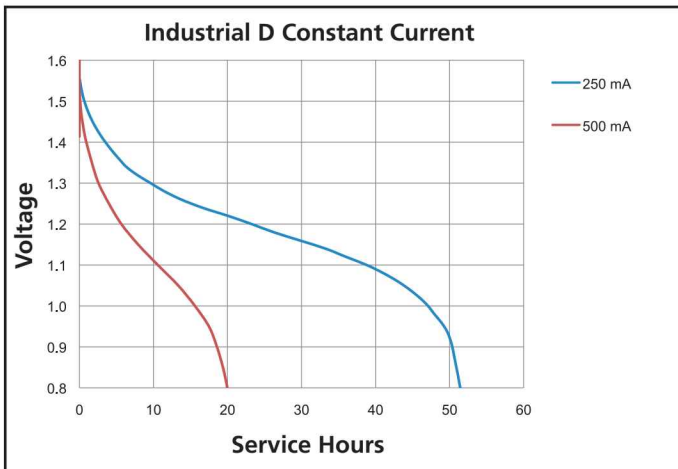
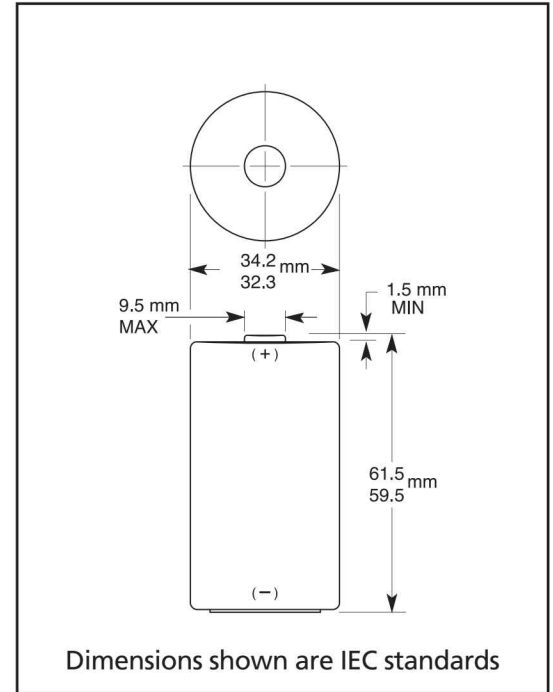

DURACELL
BATTERIES

Berkshire Corporate Park
Bethel, CT. 06801 U.S.A.
Telephone: Toll-free 1-800-544-5454
www.duracell.com

Delivered capacity is dependent on the applied load, operating temperature and cut-off voltage. Please refer to the charts and discharge data shown for examples of the energy/service life that the battery will provide for various load conditions.

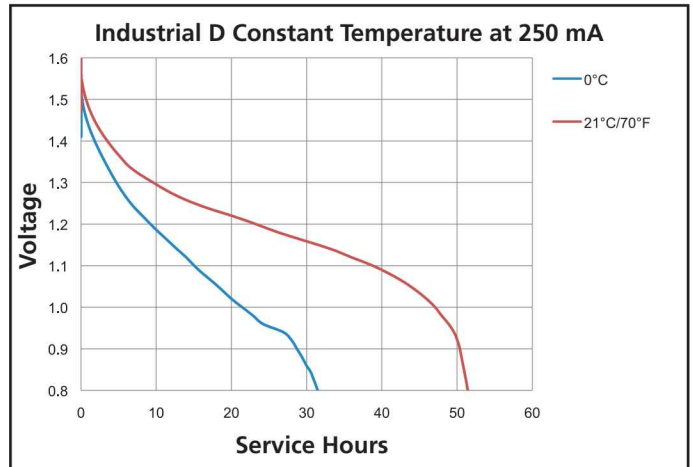
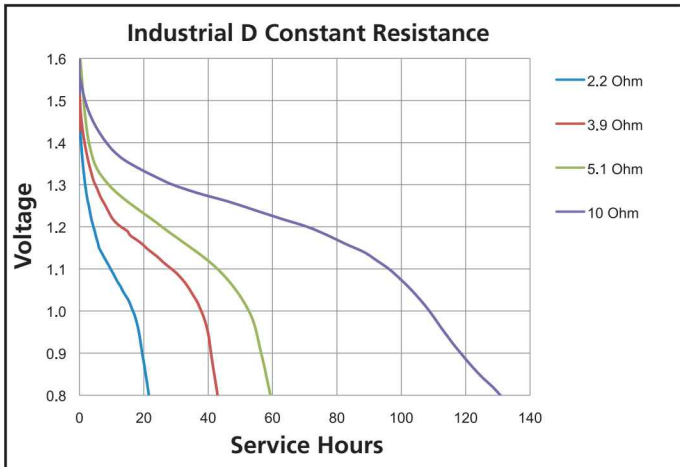
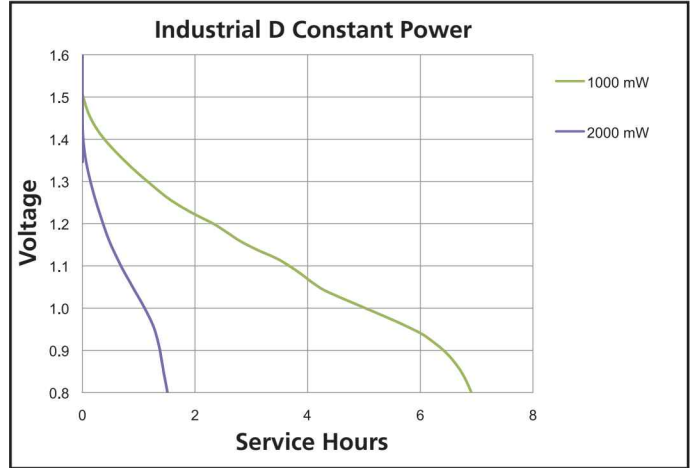
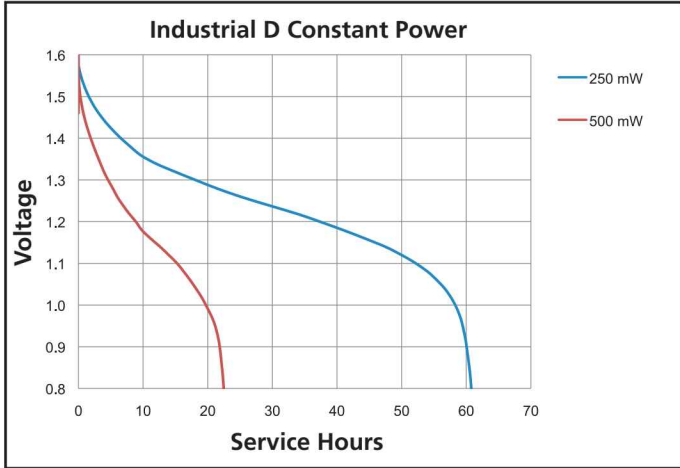

DURACELL[®]
BATTERIES

Berkshire Corporate Park
Bethel, CT. 06801 U.S.A.
Telephone: Toll-free 1-800-544-5454
www.duracell.com

Delivered capacity is dependent on the applied load, operating temperature and cut-off voltage. Please refer to the charts and discharge data shown for examples of the energy/service life that the battery will provide for various load conditions.