

1

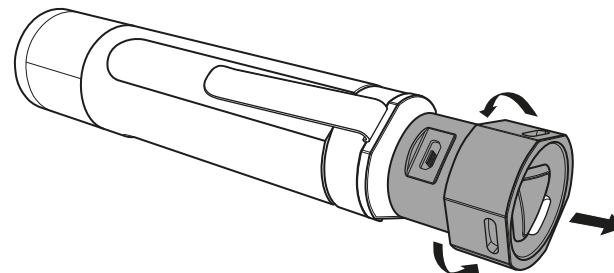

TWIST

2

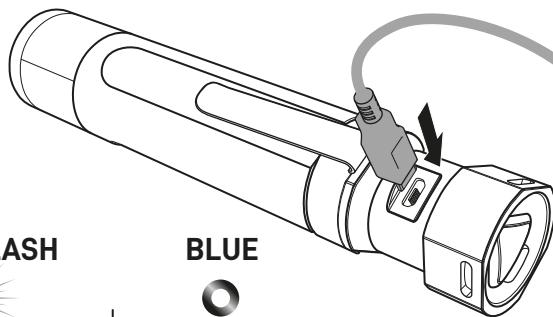

RED FLASH

BLUE FLASH

BLUE

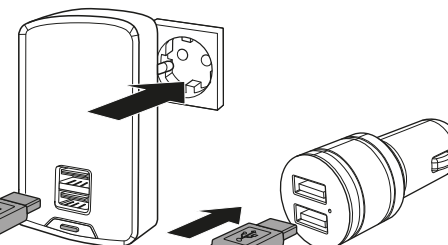
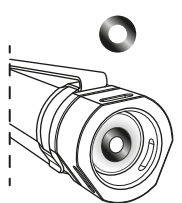
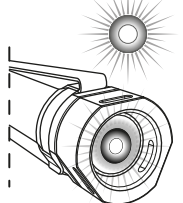
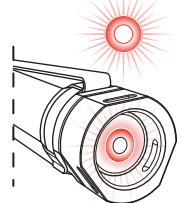

5V/500-2000 mA

3 a)

I

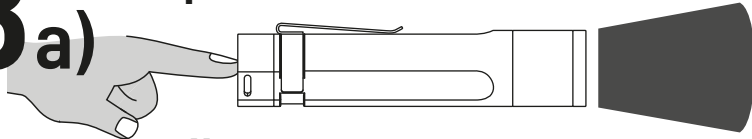

II

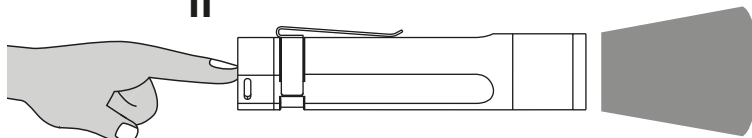

III

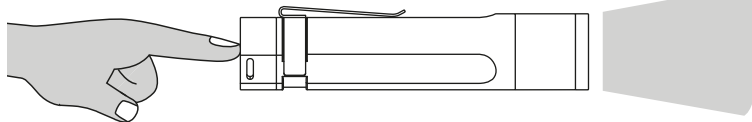

b)

2x

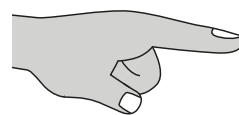

STROBE

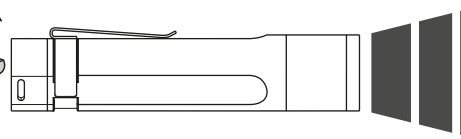

c)

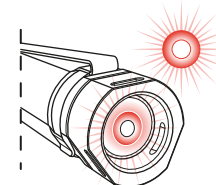

LOW BATTERY

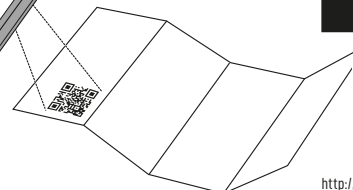
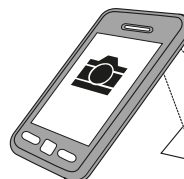

VARTA



18900
750 969

<http://www.varta-consumer.com>