

PicoVNA[®]

6 GHz and 8.5 GHz vector network analyzers

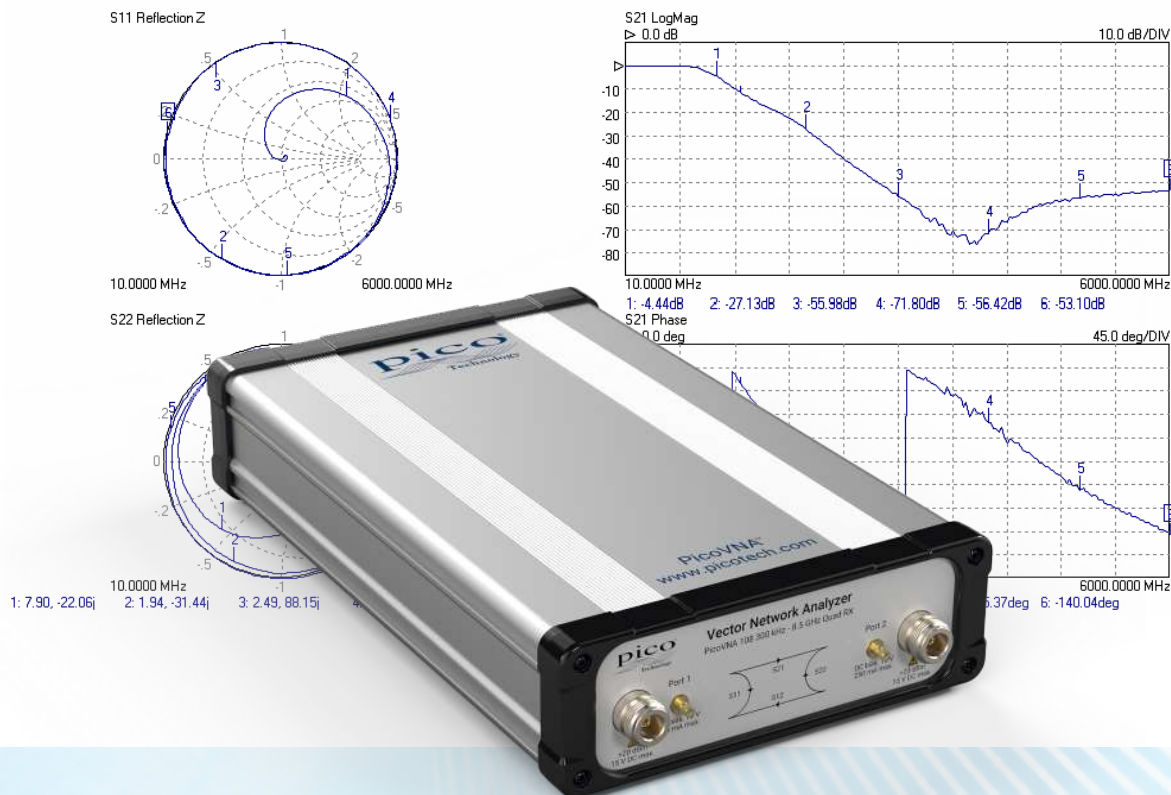

Professional and portable performance at low cost

300 kHz to 6 or 8.5 GHz operation

High speed, up to 5500 dual-port S-parameters per second

> 10 000 $S_{11} + S_{21}$ per second

Quad RX four-receiver architecture for best accuracy

Up to 124 dB dynamic range at 10 Hz bandwidth

0.005 dB RMS trace noise at maximum bandwidth of 140 kHz

Half-rack, small-footprint, lightweight package

Reference plane offsetting and de-embedding

Time domain and port impedance transformations

Tabular and graphic print and save formats, including Touchstone

Save on trigger for high-speed device profiling (PicoVNA 108)

Dual-frequency mixer measurements with VSWR correction (PicoVNA 108)

Phase meter, P1dB, AM to PM, and stand-alone signal generator utilities

Guided 8/12-term and absolute power calibration processes

6 calibration modes, including unknown through and connected DUT isolation

Calibration and check standards with data guarantee confident measurements

Vector network analysis for the many

Once the domain of an elite few, microwave measurement has encroached into the lives of scientists, educators, surveyors, inspectors, engineers and technicians alike. Today's microwave measurements need to be straightforward, portable, accurate, cost-effective and easy to learn.

PicoVNAs are all-new, UK-designed, professional USB-controlled, laboratory grade vector network instruments of unprecedented performance, portability and value for money. Despite their simple outline, small footprint and low cost, the instruments boast a four-receiver architecture to minimize the uncorrectable errors, delays and unreliability of internal transfer switches.

The PicoVNA 108 delivers an exceptional dynamic range of 124 dB at 10 Hz (118 dB for the PicoVNA 106) and less than 0.006 dB RMS trace noise at its maximum operating bandwidth of 140 kHz. The instruments can also gather all four S-parameters at each frequency point in just 182 μ s (PicoVNA 106) or 189 μ s (PicoVNA 108) or $S_{11} + S_{21}$ in less than 100 μ s. In other words, a 201 point 2-port .s2p Touchstone file in less than 38 ms or up to two .s1p files in less than 20 ms. Their low price makes them cost-effective as deep dynamic range scalar network analyzers or single-port vector reflectometers as well as full-function dual-port, dual-path vector network analyzers. They are affordable in the classroom, in small businesses and even in amateur workshops, yet capable of meeting the needs of all users up to the laboratory or production test technician or the metrology expert.



Metrology and working standard accessories



6 GHz and 8.5 GHz models



Teaching aids and CAD integrations

Vector network analysis everywhere

The PicoVNAs' small size, light weight and low cost suit them to field service, installation test, embedded and classroom applications. With their remote automation capability, they are also attractive in applications such as:

- Test automation, including multiple VNA control and measurement
- Manufacturers needing to integrate a reflectometry or transmission measurement core
- Inspection, test, characterization and calibration in the manufacture, distribution and service center industries
 - Electronics component, assembly and systems, and interface/interconnect ATE (cable, PCB and wireless)
 - Material, geological, life science and food sciences; tissue imaging; penetrating scan and radar
- Broadband cable and harness test and matching at manufacture and installation, and fault-over-life monitoring
- Antenna matching and tuning

Software development kits, including code examples in MATLAB and MATLAB RF toolbox, LabVIEW, C, C# and Python, are all available for download from Pico Technology's GitHub pages. Examples include multiple instrument addressing and control.

Multiple-unit remote control



Quad RX four-receiver, single-sweep, architecture

The PicoVNAs integrate a fast-stepping sine-wave signal source with a very fast-settling port transfer switch. Faster than dual-sweep competitor VNAs, within a single frequency sweep, at each frequency point, the PicoVNAs stimulate both ports in turn and twice measure phase and amplitude of incident, reflected and transmitted waves at the four receivers. This could be achieved with a degree of accuracy with a single source, a transfer switch and two receivers; the latter inputs being switched through a further pair of transfer switches. Alternatively, three receivers can be used with an additional input transfer switch. The PicoVNA, however, uses four receivers. This eliminates the receiver input transfer switch errors (chiefly leakage and crosstalk) that cannot otherwise be corrected. These residual errors are always present in two- and three-receiver architectures and lead to lower accuracy than that of the *Quad RX* design.

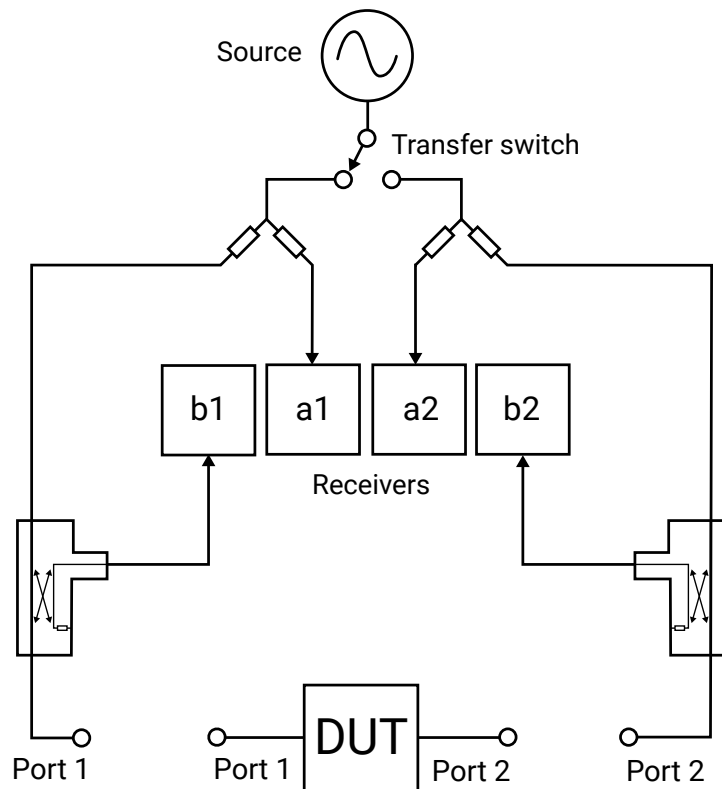

Support for 8 and 12-term calibration and the *unknown thru*

Almost all vector network analyzers are calibrated for twelve error sources (six for each signal direction). This is the so-called *12-term calibration*, which experienced VNA users are used to performing fairly regularly. In a four-receiver design some error sources are so reduced that *8-term calibration* becomes possible, along with an important and efficient calibration technique known as the *unknown thru*. This gives the ability to use any *thru* interconnect (including the DUT) during the calibration process, vastly simplifying the procedure and reducing the number of calibration standards that need to be maintained. Advanced vector network analyzer users will be pleased to know that internal a-wave and b-wave data can be exported for diagnostic use.

Bias-Ts

Bias-Ts are often not provided, or available as costly extras, on other VNAs. Use the PicoVNAs' built-in bias-Ts to provide a DC bias or test stimulus to active devices without the complexity and cost of external DC-blocks. The bias is supplied from external power supplies or test sources routed to the SMB connectors next to each VNA port.

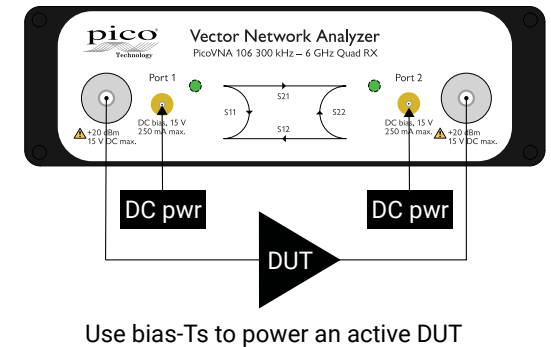

Other I/O

Power (12 to 15 V DC, 25 W) and USB 2.0 control are located on the rear panel. Trigger I/O for sweep synchronization and 10 MHz I/O for reference clock synchronization are available on four BNC sockets.

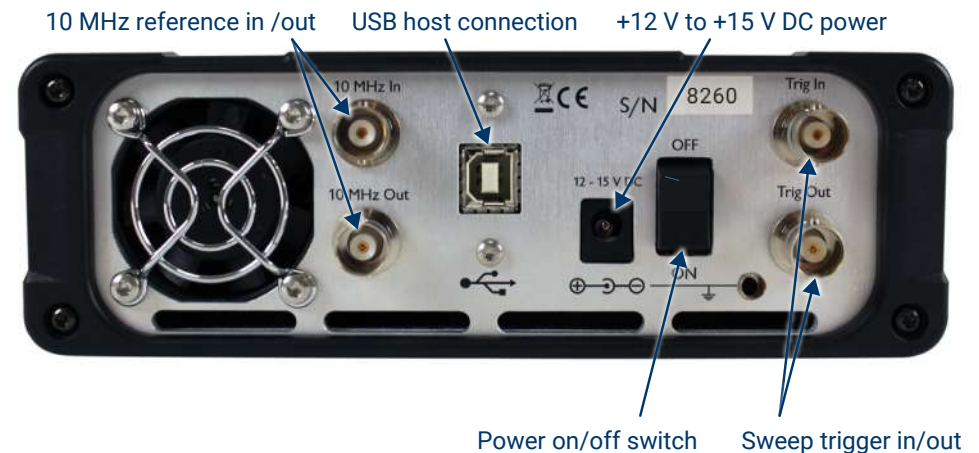





Test cables, adaptors, calibration standards and measurement check standards

A range of high-integrity RF and Microwave accessories are available from Pico Technology. Test cables and calibration standards strongly influence the overall performance of a VNA, so we recommend that you select your accessories and perform your calibrations carefully.







Cables and standards are often the weakest links in a VNA measurement, generally contributing significantly to measurement uncertainty despite their traditionally high cost. At the lowest levels of uncertainty, costs can be significant and measurements can be compromised by seemingly quite minor damage or wear. For these reasons, many customers hold both premium-grade items for calibration, reference or measurement standards, and standard-grade items as working standards and cables. Pico Technology now offers cost-effective solutions in both grades. In general we recommend PC3.5 interfaces for premium or reference use and SMA interfaces for working use.

Phase- and amplitude-stable test leads

Two test cable types and grades are recommended and provided by Pico Technology. Both of high quality, with robust and flexible construction and stainless steel connectors, the main differences between them are the provision of PC3.5 or SMA test ports and the stability of their propagation velocity and loss characteristic when flexed; that is, the degree to which a measurement could change when the cables are moved or formed to a new position. Cables are specified in terms of flatness and phase variation at up to 8.5 GHz when a straight cable is formed as one 360° turn around a 10 cm mandrel.





Order code		Grade	Connectors	Dielectric	Ø over jacket	Impedance (Ω)	Loss	Phase stability	Amplitude stability @ 6 GHz	Length	
TA336		Standard	N(m)-SMA(m)	Low-density PTFE	7.1 mm (0.28")	50	0.7 dB @ 6 GHz 0.85 dB @ 8.5 GHz	2° @ 6 GHz 2.8° @ 8.5 GHz	0.1 dB	600 mm	
TA337			N(m)-SMA(f)								
TA338		Premium	N(m)-PC3.5(m)		7.5 mm (0.30")		0.6 dB @ 6 GHz 0.7 dB @ 8.5 GHz	0.8° @ 6 GHz 1.1° @ 8.5 GHz			0.05 dB
TA339			N(m)-PC3.5(f)								

Test port adaptors

Order code		Name	Grade		Impedance (Ω)	Bandwidth (GHz)	Connector type*
TA342		ADA-STD-MM	Standard		50	18	SMA(m-m)
TA343		ADA-STD-FF					SMA(f-f)
TA357		ADA-STD-FM					SMA(f-m)
TA340		ADA-PREM-MM	Premium		50	27	PC3.5(m-m)
TA341		ADA-PREM-FF					PC3.5(f-f)
TA354		ADA-PREM-FM					PC3.5(f-m)

Calibration and measurement reference standards

Pico Technology also offers two short, open, load and through (SOLT), 4-piece, 5-port calibration kits in both male and female genders. All kits have high-performance, tight-tolerance stainless steel interface connectors. Kits are supplied as an assembled five-port “Y” SOLT, either male or female. They can be disassembled for individual usage, or for economical refurbishment should a calibration standard be damaged. Each SOLT is supplied with calibration data linked to the kit serial number and is supplied in a protective carry case. Both the Standard and Premium kits offer exceptional residual directivity for the price. It is this that combines with good uncorrected port match on the PicoVNAs to deliver exceptional price-performance. Premium PC3.5 kits are calibrated to reduced uncertainty using TRL (through, reflect, line) intercomparison above 1.5 GHz. All kits are calibrated against fully traceable PC3.5 standards. Further specifications for the instrument and calibration kits can be found on later pages. We also offer a calibration service for Pico standards – see [Ordering information](#).

Order code		Name	Grade	Ports	Impedance (Ω)	Bandwidth (GHz)	Connector type*
TA344		SOLT-STD-M	Standard	5: short, open, load, through	50	8.5	SMA(m)
TA345		SOLT-STD-F					SMA(f)
TA346		SOLT-PREM-M	Premium	5: short, open, load, through	50	8.5	PC3.5(m)
TA347		SOLT-PREM-F					PC3.5(f)

* SMA, PC3.5 and K-type/2.92 connectors can all be mated with each other. SMA type has solid dielectric, PC3.5 has air dielectric.

Test cables and calibration standards selection guide

Calibration kits can be purchased as a pair or as a single kit depending on the primary (best uncertainty) measurement application and its DUT interface, and sometimes to meet a secondary purpose with other DUT interfaces. Budget may also be a consideration. Pico Technology provides for all purchase options. You can order any combination of accessories, but to get you started we recommend that you choose one of the following standard configurations.

Recommended 'universal' configuration

For best overall test efficiency and uncertainty in a mix of single-port or dual-port test applications of both genders, we recommend this dual-port, insertable test lead and calibration standards configuration and the use of additional test port adaptors as necessary. All calibration modes are then available and where needed port adaptors can be fully included in the calibration.

Primary DUT interface	Accessory grade	Test leads required	Calibration kits required	Supported measurement and calibration modes	Suited to DUTs...
Dual-port insertable with a male and a female port	Choose: Standard SMA	1x male + 1x female: TA336 + TA337	1x male + 1x female: TA344 + TA345	All S-parameters and calibration modes	Insertable dual-port devices and any single-port male or female device. Use and fully calibrate port adaptors for dual-port single-gender noninsertable devices.
	Premium PC3.5	TA338 + TA339	TA346 + TA347		

Single-gender port configurations

The following configurations are recommended where there is a focus on a particular port gender, single-port DUT or noninsertable dual-port DUTs of a single gender.

Primary DUT interface	Accessory grade	Test leads required	Calibration kits required	Supported measurement and calibration modes	Suited to DUTs...
Single port or dual-port noninsertable with female port(s)	Choose: Standard SMA	2x male* TA336	1x female: TA345	All S-parameters and all calibration modes except insertable	Noninsertable dual female port devices and single female port devices.
	Premium PC3.5	TA338	TA347		Use port adaptors for male port devices, separately measured and de-embedded**.
Single port or dual-port noninsertable with male port(s)	Choose: Standard SMA	2x female* TA337	1x male: TA344		Noninsertable dual male port devices and single male port devices.
	Premium PC3.5	TA339	TA346		Use port adaptors for female port devices, separately measured and de-embedded**.

* Can reduce to a single test lead in single-port measurement applications.

** With only one calibration kit it is not possible to calibrate after port gender adaptation. Purchase a second calibration kit of opposing gender for full calibration of a port adaptor. Alternatively, once a noninsertable calibration has been performed, it is possible to measure the port adaptor(s) and de-embed their error. A third option is to use reference plane shift and/or normalization for a lesser correction of adaptor errors.

Check standards

We offer two economical check standards that can be used to validate the accuracy of a network analysis test setup and its calibration before and during or after measurements are made. Akin to the Beatty line, each check standard is a short length of mismatched line (75 mm of 25 Ω) with a predictable, smooth and stable mismatch and transmission characteristic that spans the frequency range of the PicoVNAs. These devices validate system measurement accuracy in the presence of high and varying mismatch and thus present a demanding validation on which to base confidence in a setup.

A comparison utility is provided in the PicoVNA 2 and 3 software (described on later pages) to evaluate the comparison against a combination of specified measurement uncertainties for the device, test leads and instrument. Each check standard is supplied with Touchstone measurement data on USB memory stick. The data is traceable via PC3.5 standards to national standards. The supplied Touchstone measurement data is compatible with, and can be used to manually validate a measurement of, any manufacturer's VNA.

Two check standards are available: insertable SMA(m-f) and noninsertable SMA(f-f).

Order code		Name	Port connectors	Parameter	Minimum	Maximum	Impedance (Ω)	Bandwidth (GHz)	Supports S-parameters and calibration modes
TA430		CHK-INS-MF Insertable with a male and a female port	Port 1: SMA female	Return loss	< -30 dB	> -6 dB	25	8.5	All S-parameters and insertable 12-term calibration mode
			Port 2: SMA male	Insertion loss	> -0.2 dB	< -1.9 dB			
TA431		CHK-NON-F Noninsertable with female ports	Port 1: SMA female	Return loss	< -30 dB	> -6 dB	25	8.5	All S-parameters and noninsertable, known and unknown through calibration modes
			Port 2: SMA female	Insertion loss	> -0.2 dB	< -1.9 dB			

Please see *Software description* and *Specifications* for further details.

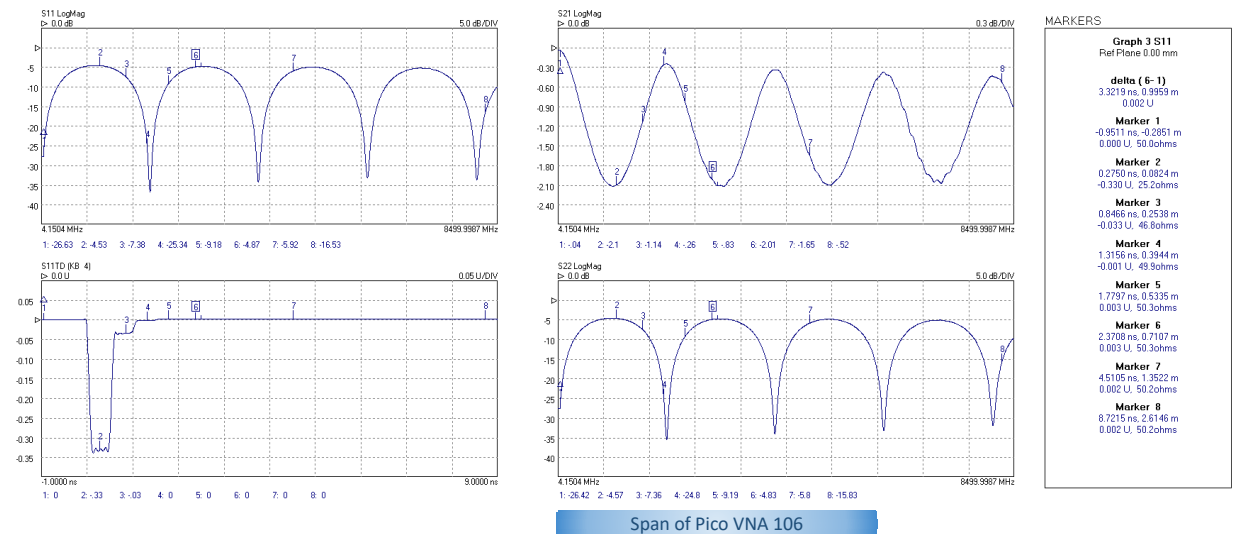

S-parameter and time-domain plots for TA431 over an 8.5 GHz span. Minor but within-specification S_{21} measurement errors present.

6 GHz Network Metrology Training and Metrology Kits

The low-cost PicoVNA 106 opens up the potential for every student or trainee to learn through the use of a full-function professional-grade vector network analyzer. The Pico PQ186 Network Metrology Training Kit builds on this opportunity and supports a wide variety of learning and experiment. Central to the kit is the separately available PQ189 Network Test PCA. This printed circuit accessory hosts a variety of example lumped element, active and passive and transmission line DUTs and end-of-line SOLT (short-open-load and thru) calibration standards.

Used with the PicoVNA 106 or 108, the kit supports teaching objectives around reflection and transmission measurements, S-parameters and other standard measurement quantities. These can be presented and interpreted as log, linear, phase, real, imaginary, polar and Smith chart formats and derived quantities group delay and time domain transmission and reflection. Additionally, by including an active broadband amplifier element (+5 V DC power required, 2.1 mm jack), nonlinear compression measurements such as P1dB and AM to PM (phase due to amplitude modulation) can be explored using the PicoVNA 106's built-in measurement utilities.

Measurements and calibrations are made via industry-standard SMA connectors. These support measurements out to 6 GHz and the teaching of best interconnection practice and the importance of secure, repeatable and robust connections. Using the on-board calibration standards the student can practice calibration for reflection, transmission and 8- and 12-term corrections using short-open-load and the known and unknown thru methods.

Also included in the kit is a set of budget SMA(f) SOLT calibration standards (PQ190). With these the student can calibrate at cable ends rather than on board. This supports teaching and experiment around reference plane shift, normalization and the de-embedding of feedlines and connections on the PCA. Assumed 'ideal' and typical calibration data for these standards can be downloaded from picotech.com, along with the comprehensive user's and trainer's guide and referenced instrument settings files. Students with access to the AWR Design Environment can also download the Microwave Office design project for the kit PCA. Pico's Cadence AWR DE interface wizard can then import real-world measured data directly to the project to allow measurement enhanced simulation or comparison with the design simulations. Software development kit examples are also available via GitHub (github.com/picotech) to import and work with measured data in other CAD, test and programming environments such as MATLAB, LabVIEW, C, C#, C++ and Python.

The Pico PQ186 Network Metrology Training Kit includes N(m) to SMA(f) inter-series adaptors, SMA(m-m) test leads and fixed SMA wrenches – all that the student will need to pair with the PicoVNA 106 (or any other VNA) to begin their practical learning. Printed circuit layout of the network test PCA is generic to support modification to alternative passive network and components.



PCA includes example attenuator, broadband amplifier, 25 Ω mismatched line, resistive power divider, low pass and bandpass filters and a user chip component site, plus short, open, load and thru calibration elements.

Two Network Metrology Demonstrator kits are also offered. These include Pico's now widely respected Standard SMA or Precision PC3.5 professional grade test leads, a female SOLT calibration kit and an SMA non-insertable female to female Check Standard; both with reference data, traceable back to national standards. Either of these kits can realise and verify the full measurement capability and accuracy of the PicoVNA 106. High-quality, low-uncertainty measurements can then be made, suiting this training investment to much wider application within research and doctorate projects. Accurate measurement can also establish accurate reference and error terms in the measurements that students are making when using the PQ186 Network Metrology Training Kit.



PQ187

Order code	Description	Notes	USD*	EUR*	GBP*
PQ186	Network Metrology Training Kit and carry case	<i>Incl: PQ189 training PCA, PQ190 SMA(f) training SOLT kit, 2x N(m)-SMA(f) inter-series adaptor, 2x TA312 60cm SMA(m-m) test lead, TA177 SMA wrench.</i>	889	759	629
PQ189	Network Metrology Training printed circuit accessory and carry case		509	429	359
PQ187	Network Metrology Leader Standard kit SMA(f) and carry case	<i>Incl: 2x TA336 N(m)-SMA(m) standard test lead, TA345 SMA(f) SOLT calibration kit and data, TA431 SMA(f-f) non-insertable check standard and data</i>	1855	1575	1305
PQ188	Network Metrology Leader Premium Kit PC3.5(f) Demonstrator kit and carry case	<i>Incl: 2x TA338 N(m)-PC3.5(m) premium test lead, TA347 PC3.5(f) SOLT calibration kit and data, TA431 SMA(f-f) non-insertable check standard and data</i>	3125	2655	2195
PQ190	Network Metrology Low Cost SOLT Kit SMA(f)	<i>Typical .kit data can be downloaded</i>	105	89	75
PS011	+ 5 V DC plug top AC power supply and international adaptors		30	25	21

* Prices correct at time of publication. Sales taxes not included. Please contact Pico Technology for the latest prices before ordering. All part-numbered items separately available.

Computer-aided design partners

Antenna matching with Optenni Lab CAD software

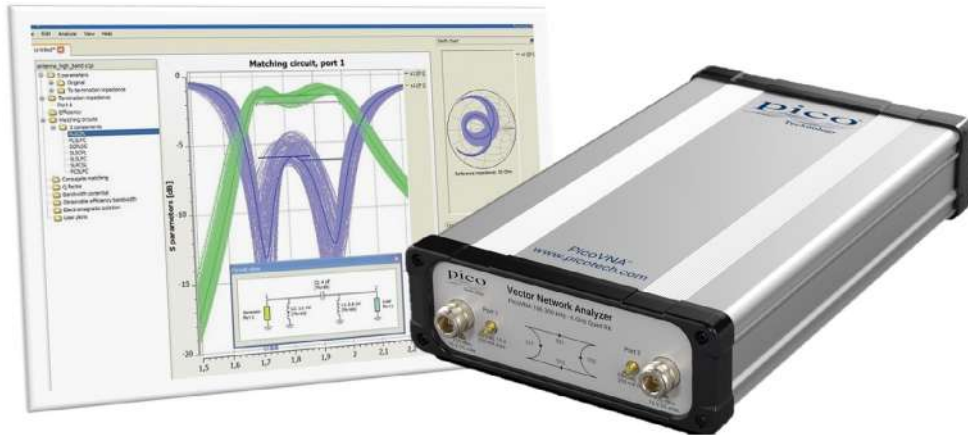

IoT, 5G, WiFi, V2X – has there ever been a bigger market explosion than the use of the antenna, and use within very challenging locations? Optenni Lab is industry-leading RF design automation software for antenna matching and RF chain performance optimization. The tool addresses multi-band, broadband, multi-antenna and tunable antenna systems and synthesizes measurement-based matching solutions in real time. In other words, Optenni Lab outputs optimized matching circuits based on live vector network analyzer measurements of antennas. Optenni Lab versions from 4.3 SP5 are compatible with the PicoVNA. The tool synthesizes optimal topologies from discrete, distributed, variable or switched component libraries against desired bandwidth and isolation targets, taking into account mutual coupling to nearby antennas. Optenni Lab automatically outputs highly complex and normally time-consuming designs. This CAD software interfaces the PicoVNA control DLL directly and no further software is required.

Cadence AWR Connected for PicoVNA

The AWR Connected wizard for the PicoVNA brings affordable vector network measurement right into the Cadence AWR Design Environment. Component, system and subsystem measurements are available, controllable and displayed inside your simulation workspace. Real-world measurements become available for one-click transfer directly to project data files – that you can use within your simulations or for direct plot and comparison.

Design–Simulate–Implement–Measure workflow is encapsulated in a single design environment, tightly coupled for optimized speed and efficiency.

Features at a glance

- Control and view PicoVNA output inside your design environment
- One-click measurement transfer to new or existing project data files or plots
- Fast, convenient comparison of ideal, modelled and measured component data
- Simulation with measured component or subsystem data
- Extend measured data to zero hertz for passive component simulation at DC
- Measure and plot active Max. Stable Gain, Available Gain, K-Factor and B1

Powerful education and training alliance

Can there be any more effective and rewarding learning experience than completing the whole design cycle? Unfortunately, the high costs of microwave network measurement have for many compromised that experience in the classroom. We believe that the more affordable PicoVNA 106 6 GHz full-function, professional-grade vector network analyzer, partnered with Microwave Office, changes the game.

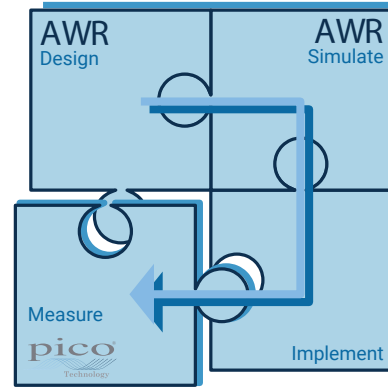

Designed within Microwave Office, the PCB project design file is available to download. Students and trainers can engage at any point in the design cycle, compare simulation with real measurement, and experiment within the simulated and real environments.

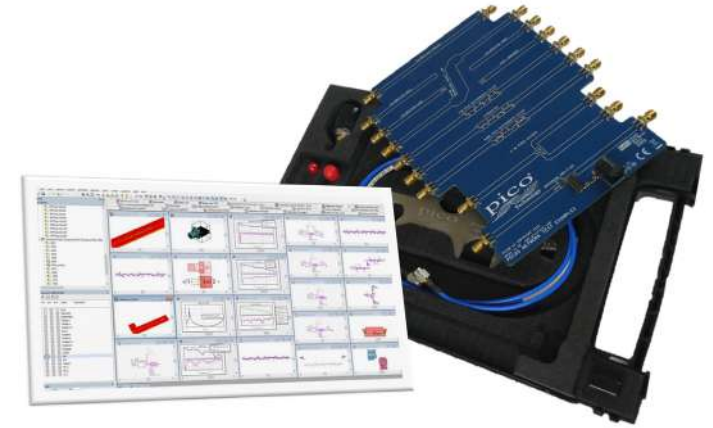

Microwave Office project file for the Network Metrology Test kit

How it works

1. Start the PicoVNA wizard to launch the PicoVNA 2 control software and establish control of the PicoVNA.
2. From the **PicoVNA** tab select your saved calibration and measurement settings.
3. Save Touchstone from here if required.

4. From the **MWO Datafile** tab select or create a project data file to receive your measured data.
5. One click creates or updates your data.

6. Optionally use the **Passive Component** or **Transistor** data tabs to create or update parameter graph plots with one click.

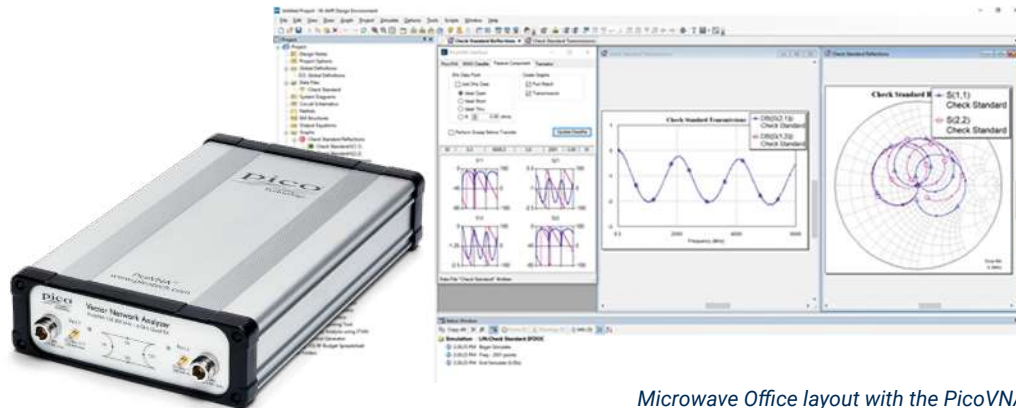

Microwave Office layout with the PicoVNA wizard (2nd panel) in the workspace

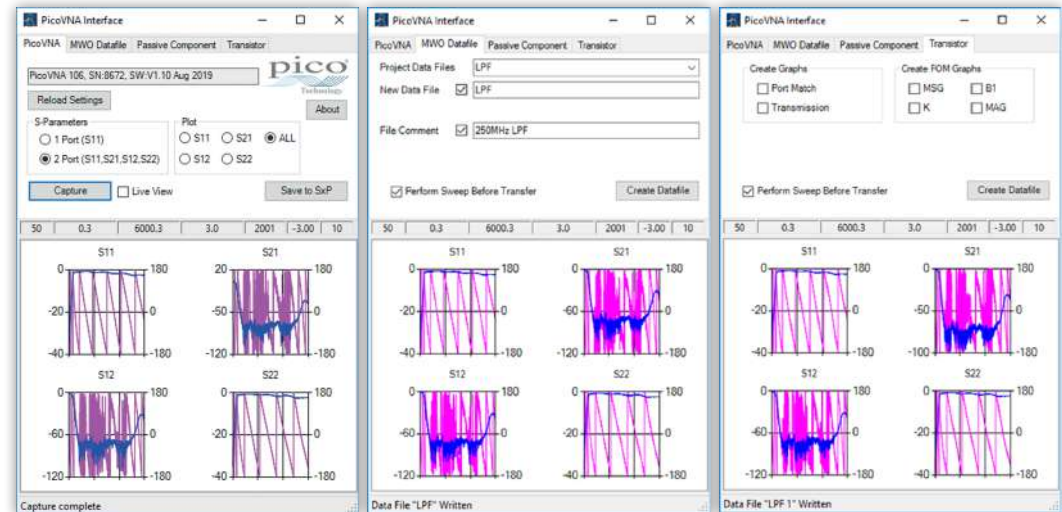

PicoVNA 2 and PicoVNA 3 software

PicoVNA 2 and 3 present standard VNA measurement and calibration simply, intuitively and with efficient usage at its heart. The software offers a comprehensive range of measurements and plot formats in their one, two or four user-configurable measurement channels. All the standard vector network analyzer functions and tabulated measurements can be seen at a glance.

Import / export, help and utilities

Save, recall, print, labels, calibration tools
 P1dB, AM to PM and signal generator utilities
 PicoVNA 108 only: Save on trigger, mixer measurements

Direct access to channel settings

Click or touch and drag values, scales and markers

Display formats

One, two or four channels

1

1

2

1 2

3 4

Plot formats

Log magnitude
 Phase
 Smith chart
 VSWR
 Group delay
 Linear magnitude
 Real
 Imaginary
 Time domain
 Polar linear

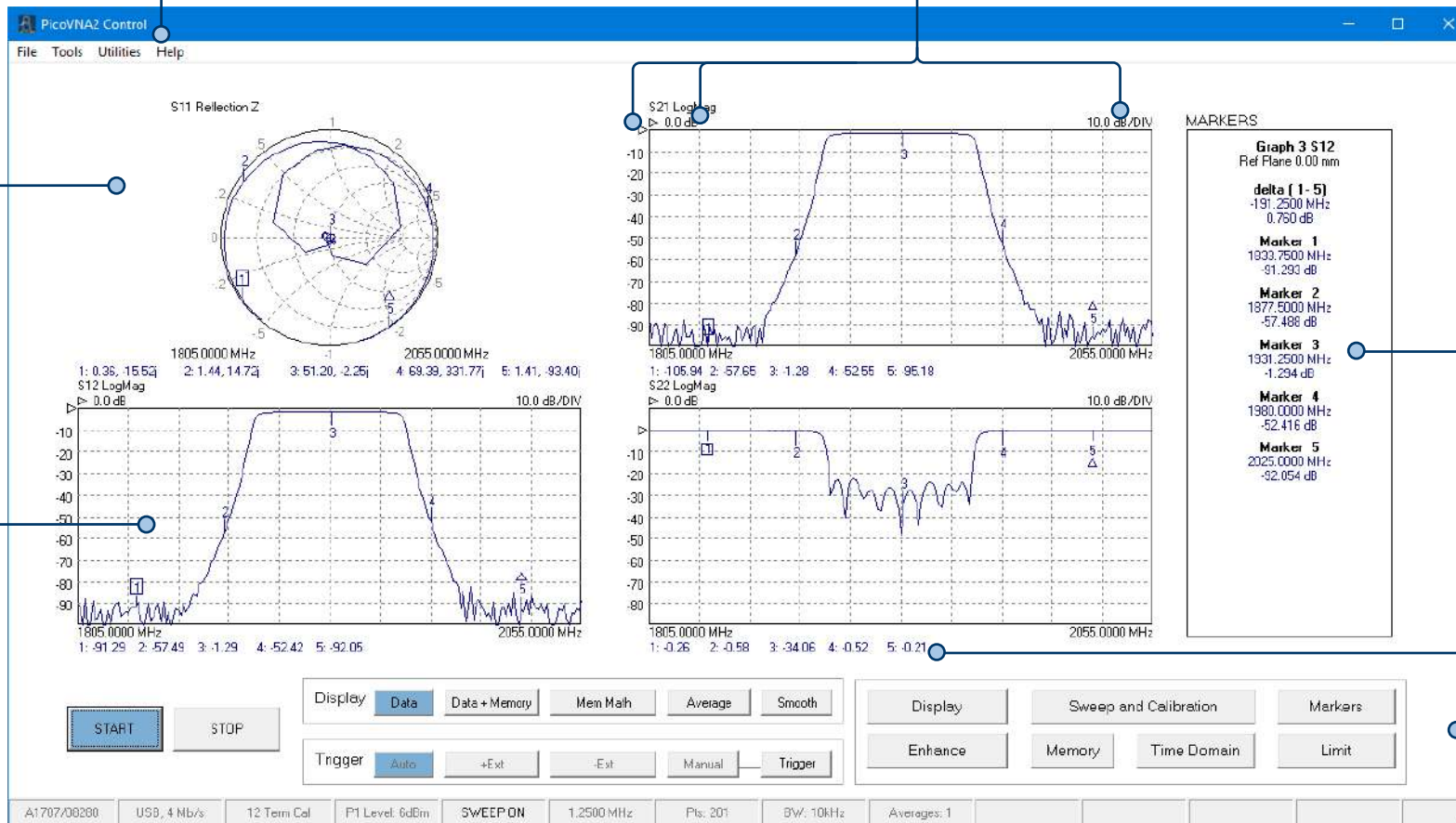

Marker readouts

Table of up to eight markers for the selected channel

Marker summary

User interface

Controls, information and vector trace math functions.

Supported calibrations

The PicoVNA 2 and PicoVNA 3 software supports a comprehensive range of calibration modes to address single or dual-port workload with male, female or mixed gender interfaces, all with best achievable accuracy (least uncertainty). In some instances only a single calibration kit may be required, as has been outlined above.

As you would expect, the Pico calibration kits are individually serial-numbered and supplied with S-parameter data. This data is a traceable and accurate record of measured errors for the calibration kit. It can be loaded into the software, which will correct for these errors and those of the instrument during a calibration.

Alternatively, you can use a third-party calibration kit whose 'model', electrical length, parasitic values and polynomial coefficients you can enter into the software and then save in Pico .kit format. Where a third party has supplied a calibration kit S-parameter data file, please ask us about the possibility of conversion to Pico format.

As for any vector network analyzer, for best accuracy a calibration is performed before a measurement with the same sweep span and frequency steps as the measurement. If, however, a change of sweep settings is necessary for a measurement, the PicoVNA 2 software will for convenience interpolate its corrections to the new sweep settings.

An *enhanced isolation* calibration setting is available for optimum dynamic range when using resolution bandwidths below around 1 kHz.

Reference plane extension

Reference plane extension (offset) allows you to shift the measurement reference plane away from the point established during calibration. This is useful in removing the path length of assumed ideal connectors, cables or microstrip lines from measurements. PicoVNA 2 and PicoVNA 3 software allows independent reference plane extensions on each of the measurement parameters (S_{11} , S_{22} , S_{12} or S_{21}), either as an automatic re-reference or by manual entry. Independent extensions allow, for example, different extensions on the two ports for S_{11} and S_{22} and then through-line normalization for S_{21} and S_{12} transmission comparison with equivalent length through-line.

Calibration Kit Parameters

Port 1 Kit name Load data available Thru data available Short and Open data available

Kit parameters

Female Male Loss (Gohm/s)

Open offset (mm)

Short offset (mm)

Open capacitance coefficients

C0(10⁻¹⁵) C2(10⁻³⁶)

C1(10⁻²⁷) C3(10⁻⁴⁵)

Short inductance

L (pH)

Thru length (mm)

Port 2 Kit name Load data available Short and Open data available

Kit parameters

Female Male Loss (Gohm/s)

Open offset (mm)

Short offset (mm)

Open capacitance coefficients

C0(10⁻¹⁵) C2(10⁻³⁶)

C1(10⁻²⁷) C3(10⁻⁴⁵)

Short inductance

L (pH)

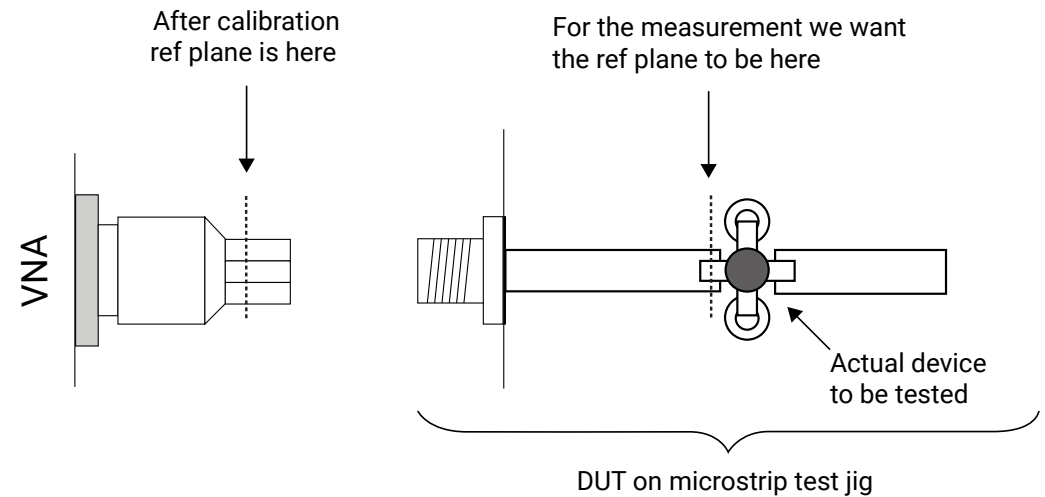

De-embedding embedded port interfaces

When it is unsafe to assume the above ideal interconnecting connectors cables or microstrip lines; for example to achieve greater accuracy or to remove known imperfections in a test setup, we can choose instead to de-embed the interface networks on each measurement port. The PicoVNA software simply requires a full Touchstone .s2p file for the embedded interfacing network on each port. Likewise, defined networks can be embedded into the measurement to achieve a desired simulated measurement. As for a calibration, best accuracy will be achieved when the embedding network is defined at the same frequency points as the intended measurement. Unusually for a vector network analyzer, the PicoVNA software will interpolate where necessary and possible.

Z_0 impedance reference

System measurement impedance (default 50 Ω) can be mathematically converted to any value between 10 Ω and 200 Ω . The PicoVNA software also supports the use of external matching pads and calibration in the new impedance using a calibration kit of that impedance.

Time-domain transmission and reflectometry measurements

Time-domain reflectometry is useful in the measurement of a transmission line or component; in particular the distance-to-fault location of any discontinuity due to connectors, damage or design error. To achieve this, the PicoVNA software determines from its frequency-domain measurements the time-domain response to a step input. Using a sweep of harmonically related frequencies, an inverse fast Fourier transform of reflected frequency data (S_{11}) gives the impulse response in the time domain. The impulse response is then integrated to give the step response. Reflected components of the step, occurring at measurable delays after excitation, indicate the type of discontinuity and (assuming a known velocity of propagation) the distance from the calibration plane.

A similar technique is used to derive a TDT (time-domain transmission) signal from the transmitted signal data (S_{21}). This can be used to measure the pulse response or transition time of amplifiers, filters and other networks.

The PicoVNA software supports Hanning and Kaiser–Bessel lowpass filtering on its time-domain IFFT conversions, preserving magnitude and phase, and achieving best resolution. Marker readouts include magnitude, time, distance and line impedance in ohms. A DC-coupled DUT is essential to the method.

The 8.5 GHz bandwidth of the PicoVNA 108 supports time-domain pulse transition times down to 58.8 ps and the PicoVNA 106 down to 82.7 ps.

P1dB utility

The 1 dB gain compression point of amplifiers and other active devices can be measured using a power sweep, either at a test frequency or over a sweep of test frequencies. The VNA determines the small-signal gain of the amplifier at low input power, and then increases the power and notes the point at which the gain has fallen by 1 dB. This utility uses a second-order curve fit to determine interpolated 1 dB compression points.

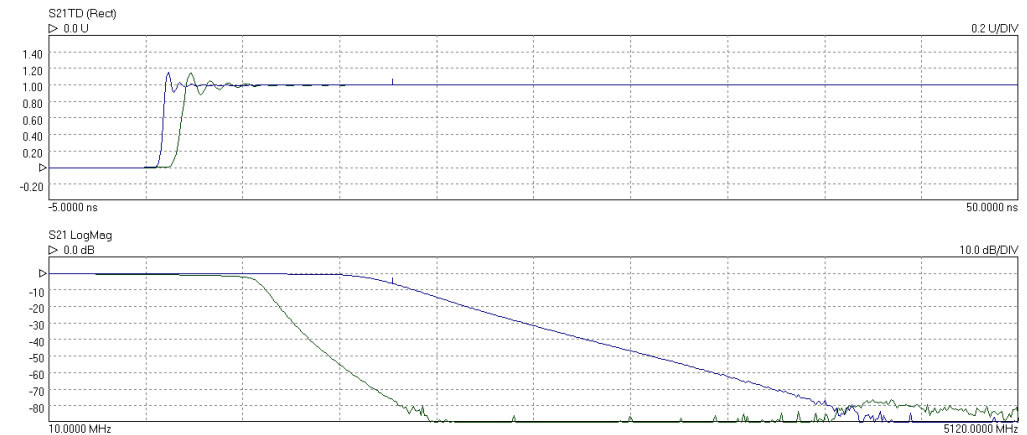

Time domain transmission step responses (top) and frequency responses (bottom) of two lowpass filters

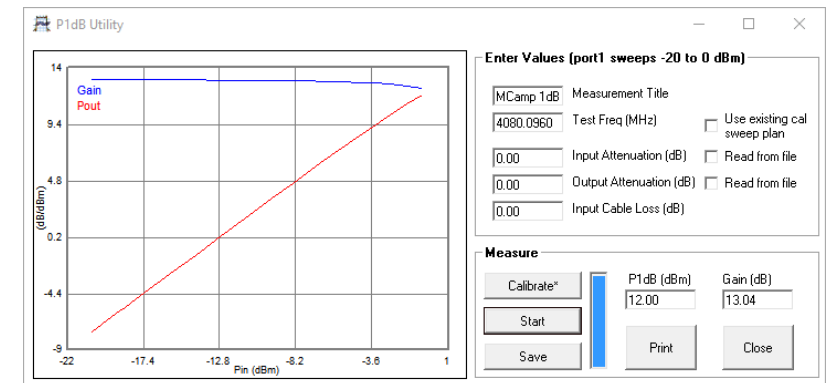

AM to PM conversion utility

AM to PM conversion is a form of signal distortion where changes in the amplitude of a signal produce corresponding changes in the phase of the signal. This type of distortion can have serious impact in digital modulation schemes for which amplitude varies and phase accuracy is important.

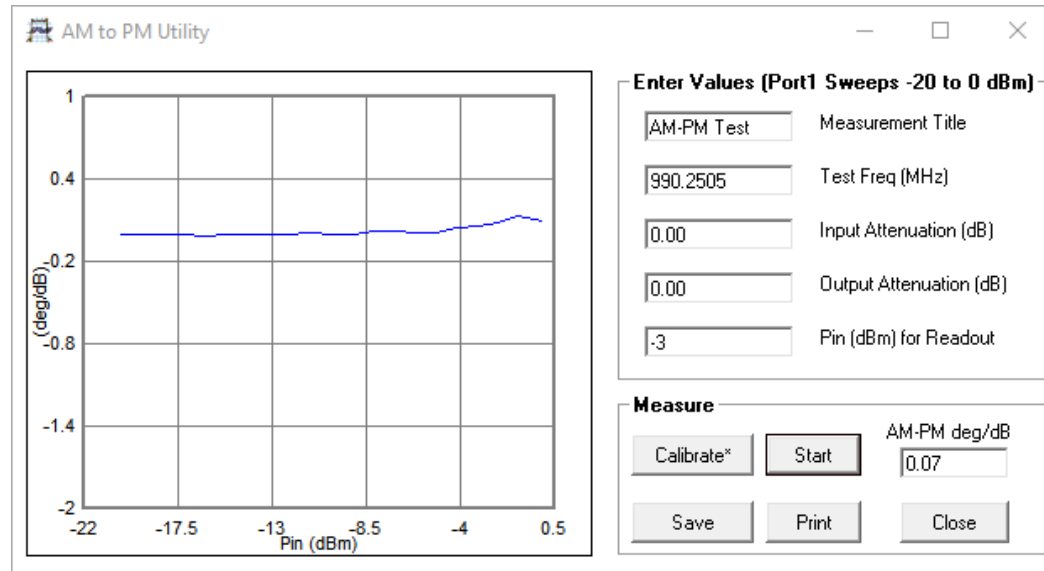

Limit lines testing

The limit lines facility allows six segments to be defined for each displayed plot. These can be extended to 11 segments using an overlapping technique. Visual and audible alarms can be given when a limit line is crossed. All plot formats except Smith chart and polar support limit testing. Peak hold functions are also available.

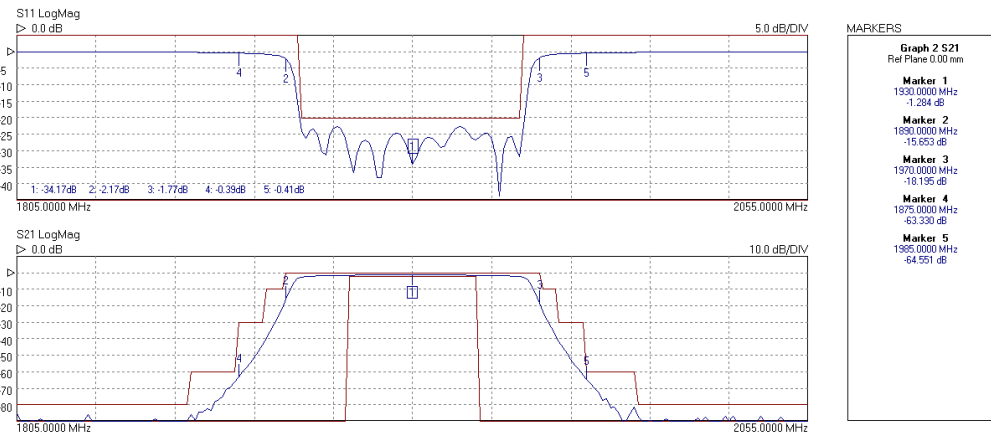

Check standard comparison utility

The supplied Touchstone measurement data for a serial-numbered check standard is loaded into the PicoVNA memory trace as a 'Reference' measurement.

With a valid, full S-parameter, full-span calibration established and the check standard connected between the test ports, the comparison utility performs a measurement. It then compares and tabulates, on each frequency point basis, the measurement with the stored 'Reference' data. Magnitude and phase difference are tabulated.

The utility combines uncertainties for the instrument and test leads (respective specifications) with measurement uncertainty and stability of the check standard (also supplied). The difference between reference and measurement is then compared with total uncertainty, giving a result of 'pass' (within uncertainty) or 'fail' (outside uncertainty).

You can save the comparison dataset for archive or analysis and a Microsoft Excel template (available for download) helps you visualize the comparison and its uncertainties.

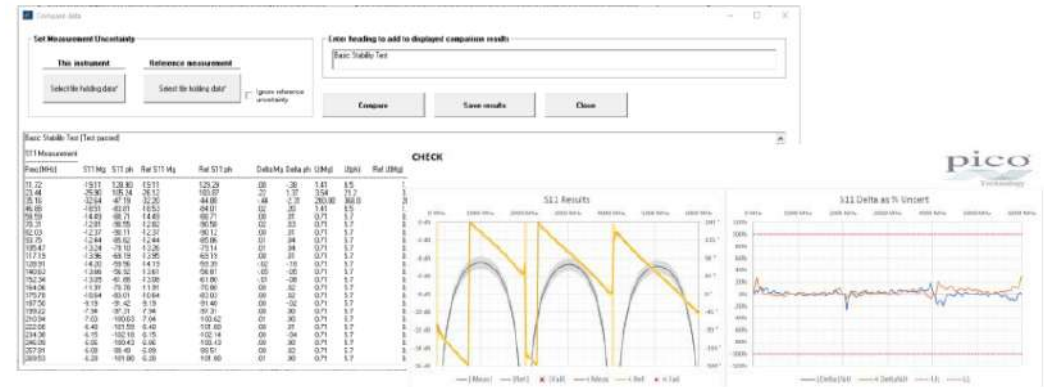

This is a very demanding evaluation of an instrument, test leads and the calibration performed, very nearly, to the full specification of the instrument and leads. The test is designed to identify a weak process, or worn, contaminated or damaged system components that might lead to a compromised measurement. To gain a pass, correct calibration procedure must be followed including the use of torque wrenches to make the connections at calibration and comparison measurements. The uncertainty data provided attempts to take into account the expected variability of your measurement setups when mating the check standard with Pico-supplied PC3.5 or SMA port connectors. There is a wide variation in the quality of commercially available test cables and SMA connectors, and contamination, damage or wear can easily occur. We guarantee that the uncertainty data provided will cover your test setups only when you use Pico-supplied calibration standards, port adaptors and test leads in new condition.

Save on trigger utility (PicoVNA 108 only)

Uniquely, benefiting from the fast measurement speed of the PicoVNA, save on trigger provides a fast and convenient method for capture and display of measurement data from multiple or changing device-under-test states. Think, for example, of variable attenuators, digitally configured filters, phase shifters or variable-gain amplifiers. Think also of devices under changing power supply, bias or environmental conditions, or even of a multiplexed measurement of a number of devices in the production environment. The PicoVNA can be set up to store up to 1024 triggered sweep measurements which can then be inspected, reordered and saved to disk in a number of formats. The trigger event can arrive on the external trigger input, or as a remote software trigger or a manual key press.





Captured measurement sweeps can be selected for display which, by default, shows one to four selected S-parameters across a maximum of 64 individually coloured traces, all plotted over the band of operation. The plotted sweeps can be any subset of all the captured sweeps and data can be normalized to one of the captured sweeps, which is useful for examining changes from sweep to sweep.

The plots to the right show S_{21} (magnitude and normalised magnitude in dB) for 16 states of a programmable step attenuator. The plot beneath and right plots S_{21} and S_{11} at a user-selected frequency of 986 MHz. Here the horizontal axis plots measurement sweep number, each in this case representing a unique state of the attenuator. All four S-parameters can be displayed simultaneously in this way on the graphs. Using a hardware external trigger and maximum resolution bandwidth, all the data for these plots was captured within 1 second!

The captured sweep data can be saved to disk in a number of formats, including Touchstone®, for use with third-party applications. Data can be saved grouped by s-parameter, for example. The file list on the right shows the files created for the stepping attenuator. You simply enter the name *Step_Attn* when saving the data, and the family of files shown is automatically created. In each of these files each column contains the S-parameter data for a given sweep. The first column after the frequency column contains data from the first sweep, the second has data from the second sweep and so on.

The data can also be saved for any single frequency within the sweep range used to capture the data. There is also an option to save the entire dataset for later use.

Name

-  Step_Attn_S11.dat
-  Step_Attn_S12.dat
-  Step_Attn_S21.dat
-  Step_Attn_S22.dat

Data can be saved to disk ordered by S-parameter

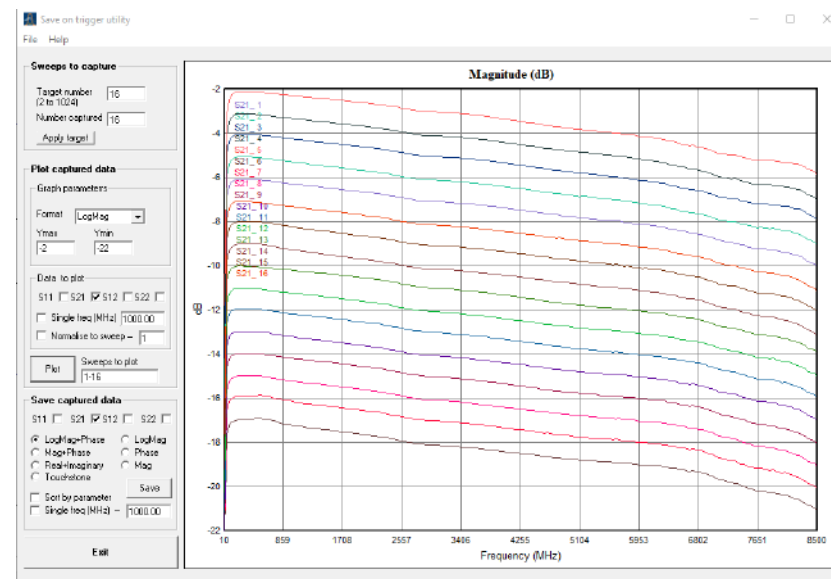

Capture and inspect multiple traces of one or multiple S-parameters. These are S_{21} plots for sixteen 1 dB increments of a step attenuator.

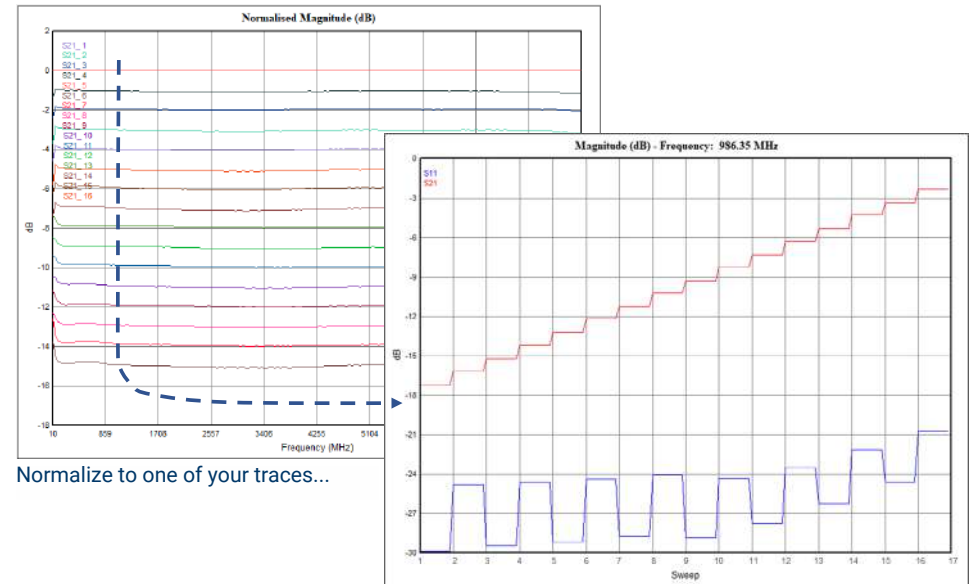

Normalize to one of your traces...

or plot a slice through your data at a single frequency. These are S_{21} and S_{11} at 986.35 MHz.

Mixer measurements utility (PicoVNA 108 only)

External local oscillator and external power sensor support

A wide range of mixer performance and port isolation measurements can be carried out, including swept RF or IF with a choice of low or high side LO. A PicoSource AS108 or a third-party signal source is used as the external LO source, and this operates under the control of the PicoVNA 3 PC application. The software also supports a third-party USB power sensor in the characterization of port power.

Supported USB-controlled signal sources	Supported USB-controlled power sensors
PicoSource AS108	Agilent / Keysight U8480, U2000
MiniCircuits SSG-15G, SSG-6000, SSG-6001	Rohde & Schwarz NRP8S, NRP8SN, NRP18S
TTi TGR 6000	
Contact the factory for your choice of external USB signal generator or power sensor to be considered.	

VSWR correction

Mixers can be difficult to measure accurately particularly when mixer port match is relatively poor. The PicoVNA 108 mixer measurement calibration includes the option of VSWR error correction. This reduces the conversion loss measurement uncertainty as typically shown in the diagram.

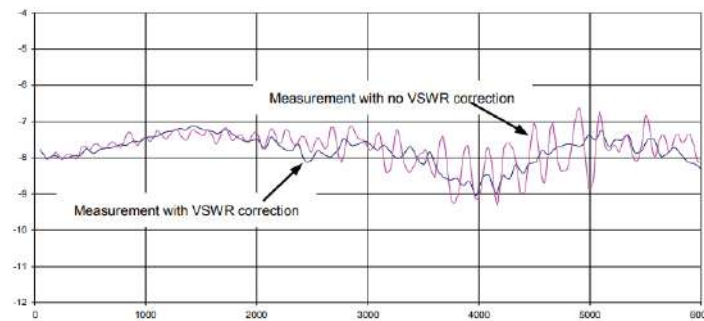

Mixer compression

Conversion loss change as a function of the input RF level is easily determined. This can be referenced either to the port power uncertainty of the PicoVNA or the user can use a third-party power sensor (above) to pre-characterize the PicoVNA 108 port power for enhanced accuracy. The 0.1 and 1 dB compression points are displayed on completion.

Phase meter utility (PicoVNA 108 only)

The phase meter adds a valuable phase and amplitude alignment and stability measurement capability to the PicoVNA 108. The two ports become auto-lock receivers at any user-specified frequency within the 300 kHz to 8.5 GHz tuning range of the VNA. The receivers will lock to externally applied signals within approximately ± 70 kHz of the set frequency and begin to measure and cross-refer phase and amplitude of the two signals as numerical readouts.

Calibration and normalization facilities are provided, allowing, for example, precise alignment of a quadrature-phase relationship or determination of differential phase and amplitude balance or stability.

The IF bandwidth setting determines displayed result resolution, update rate and also measurement noise at any given signal level. At IFB of 10 Hz, resolution is 0.001° and 0.001 dB and update rate around 4 readings per second. Amplitude and phase accuracies match those of standard VNA transmission measurements.

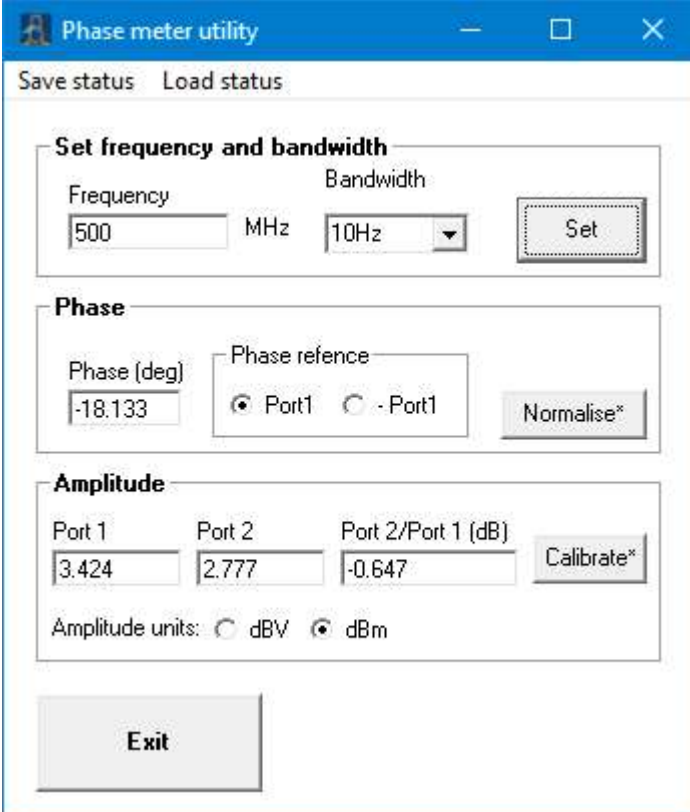

The screenshot shows the 'Phase meter utility' software window. It features a blue title bar with the text 'Phase meter utility' and standard window controls. Below the title bar are two buttons: 'Save status' and 'Load status'. The main interface is divided into three sections:

- Set frequency and bandwidth:** Contains a 'Frequency' input field with the value '500' and the unit 'MHz', a 'Bandwidth' dropdown menu with '10Hz' selected, and a 'Set' button.
- Phase:** Contains a 'Phase (deg)' input field with the value '-18.133', a 'Phase reference' section with radio buttons for 'Port1' (selected) and '-Port1', and a 'Normalise*' button.
- Amplitude:** Contains three input fields: 'Port 1' with '3.424', 'Port 2' with '2.777', and 'Port 2/Port 1 (dB)' with '-0.647', followed by a 'Calibrate*' button. Below these fields, the 'Amplitude units' are set to 'dBm' (selected) with 'dBV' as an alternative.

At the bottom of the window is a large 'Exit' button.

Specifications

Standard conditions: 10 Hz resolution bandwidth, at 13 dBm (PicoVNA 106) or 0 dBm (PicoVNA 108) test power, at an ambient temperature of between 20°C and 30°C but within 1°C of the calibration temperature and 60 minutes after power-up.

Receiver characteristics							
Parameter	Value			Conditions			
Measurement bandwidth	140 kHz, 70 kHz, 35 kHz, 15 kHz, 10 kHz, 5 kHz, 1 kHz, 500 Hz, 100 Hz, 50 Hz, 10 Hz						
Average displayed noise floor	PicoVNA 106			PicoVNA 108			Relative to the test signal level set to maximum power after an S_{21} calibration. Ports terminated as during the isolation calibration step.
	Band (MHz)	Typical (dB)	Max. (dB)	Band (MHz)	Typical (dB)	Max. (dB)	
	0.3 to 10	-110	-100	0.3 to 1	-100	-90	
	10 to 4000	-118	-108	1 to 6000	-124	-110	
	> 4000	-110	-100	> 6000	-120	-100	
Dynamic range	See graphs (typical, excludes crosstalk)			10 Hz bandwidth Maximum test power +6 dBm (6 GHz), 0 dBm (8.5 GHz). No averaging			

Dynamic range 0.3 MHz to 10 MHz (PicoVNA 106)

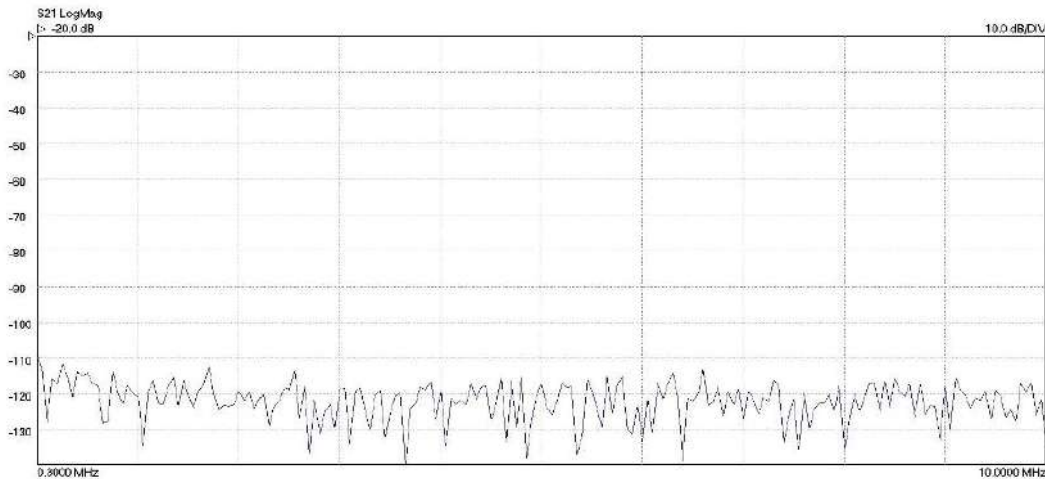

Dynamic range 10 MHz to 6 GHz (PicoVNA 106)

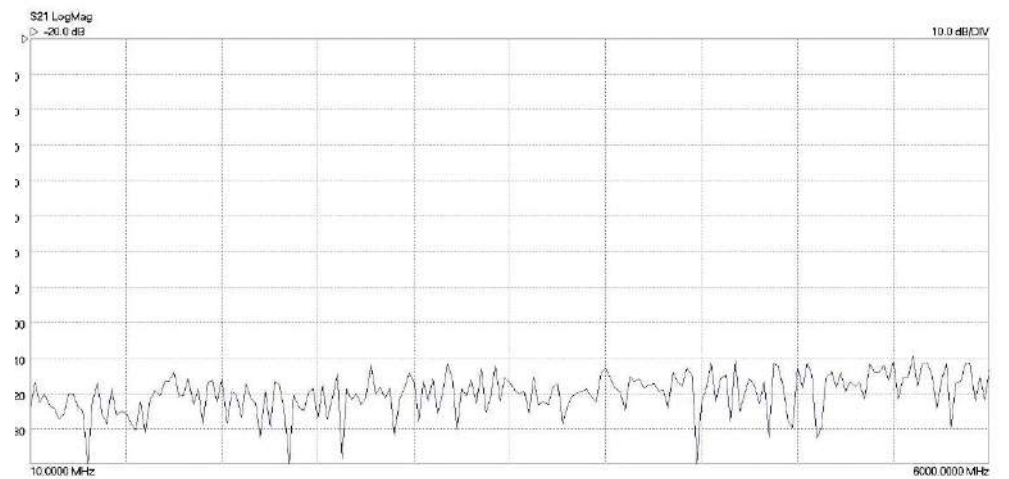

Dynamic range 0.3 MHz to 10 MHz (PicoVNA 108)

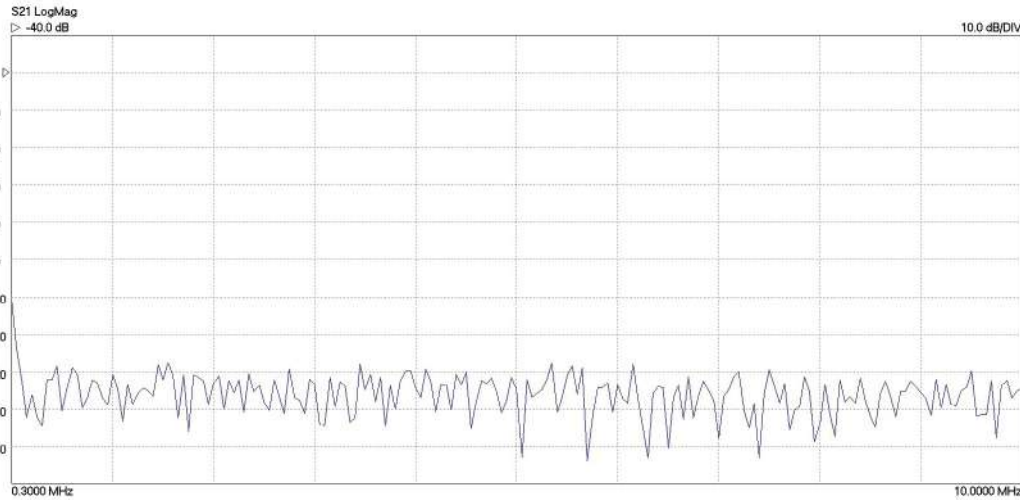

Dynamic range 10 MHz to 8.5 GHz (PicoVNA 108)

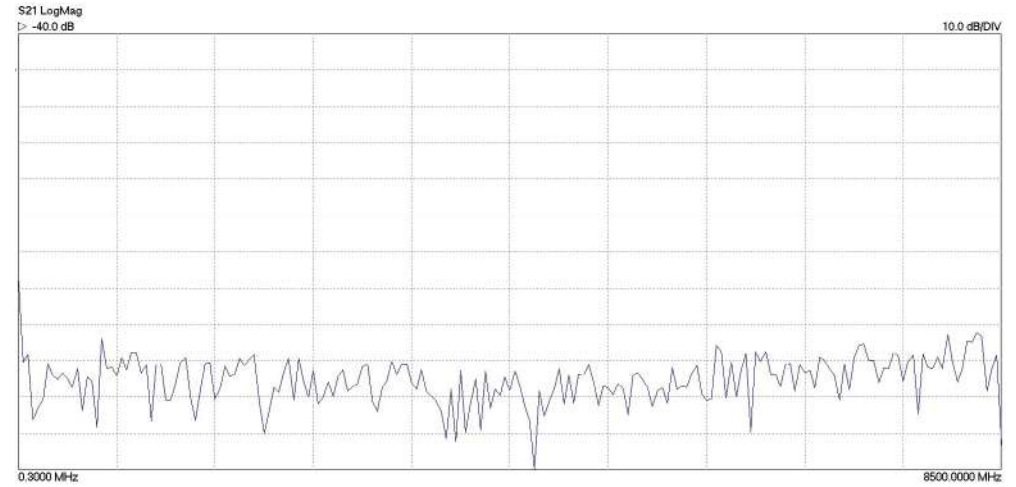

Temperature stability, typical

0.02 dB/°C for $F < 4$ GHz
 0.04 dB/°C for $F \geq 4$ GHz

Measured after an S_{21} calibration

Trace noise (RMS)

Bandwidth (kHz)	Typical (dB)	Max. (dB)
10	0.0008	0.002
70	0.003	0.005
140	0.005 (6 GHz) / 0.006 (8.5 GHz)	0.01

201-point sweep covering 1 MHz to 6 GHz or 8.5 GHz.
 Test power set to 0 dBm.

Measurement uncertainty
 PC3.5 test port interfaces

Freq. range	Reflection		Transmission	
	Level range	Mag. / phase	Level range	Mag. / phase
< 2 MHz	-15 dB to 0 dB	0.7 dB / 8°	0 dB to +6 dB	0.4 dB / 6°
		0.5 dB / 4°		0.2 dB / 2°
< 2 MHz	-25 dB to -15 dB	0.8 dB / 6°	-40 dB to 0 dB	0.3 dB / 2°
		1.0 dB / 10°		0.1 dB / 1°
< 2 MHz	-30 dB to -25 dB	3.0 dB / 20°	-60 dB to -40 dB	0.3 dB / 8° ^[6]
		2.5 dB / 15° ^[6] 3.0 dB / 20° ^[8]		0.5 dB / 8° ^[8] 0.3 dB / 4° ^[6] 0.2 dB / 4° ^[8]
> 2 MHz			-80 dB to -60 dB	2.0 dB / 15°
				1.5 dB / 12°

^[6] PicoVNA 106, ^[8] PicoVNA 108

Test level of -3 dBm.
 No averaging.
 Bandwidth 10 Hz.
 Ambient temperature equal to the calibration temperature.
 A 12 error term calibration is assumed carried out with a good quality 3.5 mm calibration kit capable of achieving the performance specified.
 PicoVNA 2: These values are supplied with our Check Standard on USB memory stick as uncertainty data file: "Instrument Uncertainty with Premium PC3.5 leads 106.dat" or: "Instrument Uncertainty with Premium PC3.5 leads 108.dat"
 PicoVNA 3: Uncertainty files are installed with the software.

Measurement uncertainty SMA test port interfaces			Reflection		Transmission		<p>Test level of -3 dBm. No averaging. Bandwidth 10 Hz. Ambient temperature equal to the calibration temperature.</p> <p>A 12 error term calibration is assumed carried out with a good-quality SMA or PC3.5 calibration kit capable of achieving the performance specified.</p> <p>PicoVNA 2: These values are supplied with our Check Standard on USB memory stick as uncertainty data file: "Instrument Uncertainty with Pico Standard SMA leads 106.dat" or: "Instrument Uncertainty with Pico Standard SMA leads 108.dat"</p> <p>PicoVNA 3: Uncertainty files are installed with the software. The main spurious response occurs close to (2 x RF + 1.3) MHz or (3 x RF + 2.6), where RF is the test frequency in MHz. For example, when testing a bandpass filter with a centre frequency of 1900 MHz, an unwanted response will occur around 632.47 MHz or 949.35 MHz. In all known cases the levels will be as stated.</p>
	Freq. range	Level range	Mag. / phase	Level range	Mag. / phase		
	< 2 MHz	-15 dB	0.99 dB / 11.3°	0 dB to	0.57 dB / 8.5°		
	> 2 MHz	to 0 dB	0.71 dB / 5.7°	+6 dB	0.28 dB / 2.8°		
	< 2 MHz	-25 dB	1.13 dB / 14.1°	-40 dB to	0.42 dB / 2.8°		
	> 2 MHz	to -15 dB	1.41 dB / 8.5°	0 dB	0.14 dB / 1.4°		
	< 2 MHz	-30 dB	4.24 dB / 28.3°	-60 dB to	0.71 dB / 11.3°		
	> 2 MHz	to -25 dB	3.54 dB / 21.2°	-40 dB	0.42 dB / 5.7°		
< 2 MHz			-80 dB to	2.83 dB / 21.2°			
> 2 MHz			-60 dB	2.12 dB / 17.0°			
Spurious responses	-76 dBc typical, -70 dBc max.						
Test port characteristics							
Load match	40 dB min. corrected, 46 dB, typ. corrected, 16 dB (PicoVNA 106) or 15 dB (PicoVNA 108), typ. uncorrected						
Source match	40 dB min. corrected, 46 dB, typ. corrected, 16 dB (PicoVNA 106) or 15 dB (PicoVNA 108), typ. uncorrected						
Directivity	40 dB min. corrected, 47 dB, typ. corrected						
Crosstalk	PicoVNA 106			PicoVNA 108			Corrected. Both calibrated ports terminated in short circuits. After isolation calibration.
	Band (MHz)	Typ. (dB)	Max. (dB)	Band (MHz)	Typ. (dB)	Max. (dB)	
	< 2	-100	-90	< 1	-100	-90	
	2 to 4000	-110	-90	2 to 6000	-110	-90	
4000 to 6000	-100	-90	6000 to 8000	-100	-90		
Maximum input level	+10 dBm, typ.						0.1 dB compression
Maximum input level	+20 dBm			+23 dBm			No damage
Impedance	50 Ω						
Connectors	Type N, female						

Calibration kits						
	Frequency	PC3.5(f)	PC3.5(m)	SMA(f)*	SMA(m)*	* SMA calibration kits are calibrated in a PC3.5 reference system.
Load uncorrected return loss	≤ 3 GHz > 3 GHz	≥ 30 dB ≥ 27 dB	≥ 30 dB ≥ 26 dB	≥ 30 dB ≥ 26 dB	≥ 28 dB ≥ 26 dB	
Load corrected return loss	≤ 3 GHz > 3 GHz	≥ 46 dB ≥ 43 dB	≥ 46 dB ≥ 43 dB	≥ 40 dB ≥ 37 dB	≥ 40 dB ≥ 37 dB	Inferred from directivity after applying correction using measured data provided with the kit
Open circuit return loss	≤ 3 GHz > 3 GHz	≤ 0.15 dB ≤ 0.2 dB				
Short circuit return loss	≤ 3 GHz > 3 GHz	≤ 0.2 dB ≤ 0.25 dB				
Through adaptor insertion loss	≤ 6 GHz	≤ 0.15 dB	≤ 0.15 dB	≤ 0.15 dB	≤ 0.2 dB	
Transfer calibration method	300 kHz to 1.5 GHz 1.5 GHz to 6 GHz	SOLT comparison TRL comparison		SOLT comparison		SOLT = short, open, load, through TRL = through, reflect, line

Check standards

Devices	Bandwidth	Return loss	Insertion loss			
TA430 CHK-INS-MF insertable TA431 CHK-NON-F noninsertable	0.3 to 8500 MHz	< -30 dB to > -6 dB	> -0.2 dB to < -1.9 dB	Formed by 75 mm of 25 Ω mismatched line		
Reference uncertainty		Reflection		Transmission		
		Freq. range	Level range	Mag. / phase	Level range	Mag. / phase
		< 2 MHz	-15 dB to	0.99 dB / 11.3°	0 dB to	0.57 dB / 8.5°
		> 2 MHz	0 dB	0.71 dB / 5.7°	+6 dB	0.28 dB / 2.8°
		< 2 MHz	-25 dB to	1.13 dB / 14.1°	-40 dB to	0.42 dB / 2.8°
		> 2 MHz	-15 dB	1.41 dB / 8.5°	0 dB	0.14 dB / 1.4°
		< 2 MHz	-30 dB to	4.24 dB / 28.3°	-60 dB to	0.71 dB / 11.3°
		> 2 MHz	-25 dB	3.54 dB / 21.2°	-40 dB	0.42 dB / 5.7°
	< 2 MHz			-80 dB to	2.83 dB / 21.2°	
	> 2 MHz			-60 dB	2.12 dB / 17.0°	

Ambient temperature 20 °C to 26 °C

PicoVNA 2: These values are supplied with our Check Standard on USB memory stick as uncertainty data file: "Check Standard Reference Measurement Uncertainty.dat".

PicoVNA 3: The software installs the two uncertainty files.

Note: The Pico TA430 and TA431 check standards can be used in the performance verification of the PicoVNA but they have too much uncertainty to make a confident verification to the full performance specification of the instrument. Nonetheless, the uncertainty of the verification, given in the result from the compare utility, may be low enough for the application. If sufficient, the use of either TA430 or TA431, of course, significantly reduces ownership costs and increases the regularity at which a verification can be made.

Bias-T input characteristics

Maximum current and DC voltage	250 mA, ±15 V
Current protection	Built-in resettable fuse
DC port connectors	SMB(m)

Sweep I/O characteristics		
Sweep trigger output voltage	Low: 0 V to 0.8 V. High: 2.2 V to 3.6 V.	
Sweep trigger input voltage	Low: -0.1 V to 1 V. High: 2.0 V to 4 V.	
Sweep trigger input voltage	±6 V	No damage
Sweep trigger in/out connectors	BNC female on back panel	
Measuring functions		
Measuring parameters	$S_{11}, S_{21}, S_{22}, S_{12}$ P1dB (1 dB gain compression) AM to PM conversion factor (PM due to AM) Mixer conversion loss, return loss, isolation and compression (PicoVNA 108 only)	
Error correction	12 error term full S-parameter correction (insertable DUT) 12 error term full S-parameter correction (noninsertable DUT) 8 error term full S-parameter unknown through correction (noninsertable DUT) S_{11} (1-port correction) De-embed (2 embedding networks may be specified) Impedance conversion S_{21} (normalize, normalize + isolation) S_{21} (source match correction + normalize + isolation) Averaging, smoothing Hanning and Kaiser-Bessel filtering on time-domain measurements Electrical length compensation (manual or auto) Effective dielectric constant correction	
Display channels	4 channels	
Traces	2 traces per display channel	
Display formats	Amplitude (logarithmic and linear), phase, group delay, VSWR, real, imaginary, Smith chart, polar, time domain	
Memory trace	One per display channel	
Limit lines	6 segments per channel (overlap allowed)	
Markers	8 markers	
Marker functions	Normal, Δ marker, fixed marker, peak / min. hold, 3 dB and 6 dB bandwidth	

Sweep functions			
Sweep type	Linear frequency sweep, CW time-based sweep, and power sweep (P1dB utility)		
Sweep times	Bandwidth	S₁₁, S₂₁, S₁₁+S₂₁ calibration	Full 12 or 8 term calibration
	140 kHz	19 ms ^[1]	37 ms ^[1]
	10 kHz	37 ms	72 ms
	1 kHz	0.21 s	0.42 s
	100 Hz	1.94 s	3.87 s
	10 Hz	19.2 s	38.4 s
	LF Adder (for each low frequency point < 2.5 MHz)	1.25 ms/pt	2.5 ms/pt
	^[1] 20 ms and 38 ms for PicoVNA 108		
	10 MHz to 6 or 8.5 GHz, 201-point trace length. For other lengths and bandwidths the sweep time is approximately: $T_{SWP}(s) = N \times (T_{MIN} + F_{BW} / R_{BW})$ where: N = number of frequency points T _{MIN} (s) = minimum time / point (s2p: 167 μs; s1p: 85 μs) F _{BW} = bandwidth settle factor (s2p: 1.91; s1p: 0.956) R _{BW} = resolution bandwidth (Hz) For sweep repetition period, add software rearm time: T _{ARM} = average 6.5 ms or worst case 50 ms For markers on, increase T _{ARM} by 39 ms		
Number of sweep points, VNA mode	51, 101, 201, 401, 801, 1001, 2001, 4001, 5001, 6001, 7001, 8001, 9001, 10 001		
Number of sweep points, TD mode	512, 1024, 2048, 4096		
Signal source characteristics			
Frequency range	PicoVNA 106		PicoVNA 108
	300 kHz to 6.0 GHz		300 kHz to 8.5 GHz
Frequency setting resolution	10 Hz		
Frequency accuracy	10 ppm max		
Frequency temperature stability	±0.5 ppm/°C max		
Harmonics	-20 dBc max		
Non-harmonic spurious	-40 dBc typical		
Phase noise (10 kHz offset)	0.3 MHz to 1 GHz: -90 dBc/Hz		
	1 GHz to 4 GHz: -80 dBc/Hz		
	> 4 GHz: -76 dBc/Hz		
Test signal power	< 10 MHz: -3 to -20 dBm	≤ 6 GHz: +10 dBm to -20 dBm > 6 GHz: +6 dBm to -20 dBm	
	10 MHz to 4 GHz: +6 to -20 dBm		
	> 4 GHz: +3 to -20 dBm		
Power setting resolution	0.1 dB		
Power setting accuracy	±1.5 dB		
Reference input frequency	10 MHz ±6 ppm		
Reference input level	0 ±3 dBm		
Reference output level	0 ±3 dBm		

Miscellaneous		
Controlling PC data interface	USB 2.0	
Support for third party test software	Dynamic Link Library (DLL) as part of user interface software	
External dimensions (mm)	286 x 174 x 61 (L x W x H) excluding connectors	
Weight	1.85 kg	1.9 kg
Temperature range (operating)	5 °C to 40 °C	
Temperature range (storage)	-20 °C to +50 °C	
Humidity	80% max, non-condensing	
Vibration (storage)	0.5 g, 5 Hz to 300 Hz	
Power source characteristics	+12 to +15 V DC, 22 W (PicoVNA 106), 25 W (PicoVNA 108)	
Power source connector	5.5 mm diameter hole, 2.1 mm diameter centre contact pin. Centre pin is positive.	
Host PC requirements	Microsoft Windows 7, 8 or 10 2 GB RAM or more	
Safety	Conforms to EN 61010-1:2010 and EN 61010-2-030:2010	
Warranty	3 years	

PicoVNA 106 (PQ111) and PicoVNA 108 (PQ112) kit contents

<p>PicoVNA vector network analyzer (Calibrated. Certificate with data available separately.)</p>	
<p>PS010 Universal input 12 V 4.5 A output power supply</p>	
<p>PA153 PicoVNA carry case</p>	
<p>DI111 PicoVNA 2 software and documents on USB flash drive</p>	
<p>TA486 PicoWrench RF combination wrench for N, SMA, PC3.5 and K-type connectors Quantity: 2.</p>	
<p>MI106 Pico blue USB 2.0 cable 1.8 m</p>	
<p>Accessories available separately</p>	
<p>TA356 Dual-break torque wrench SMA / PC3.5 / K-type TA358 Dual-break torque wrench N-type Both types: 1 N·m / 8.85 in·lb</p>	

<p>TA336 Standard test lead with SMA(m) port TA337 Standard test lead with SMA(f) port TA338 Premium test lead with PC3.5(m) port TA339 Premium test lead with PC3.5(f) port</p>	
<p>TA340 Standard PC3.5 port adaptor (m-m) TA341 Standard PC3.5 port adaptor (f-f) TA354 Standard PC3.5 port saver (m-f) TA342 Premium SMA port adaptor (m-m) TA343 Premium SMA port adaptor (f-f) TA357 Premium SMA port saver (m-f)</p>	
<p>TA344 Standard SOLT calibration kit SMA(m) with data TA345 Standard SOLT calibration kit SMA(f) with data TA346 Premium SOLT calibration kit PC3.5(m) with data TA347 Premium SOLT calibration kit PC3.5(f) with data</p>	
<p>TA430 Insertable check standard SMA(m-f) with data TA431 Noninsertable check standard SMA(f-f) with data</p>	
<p>C0046 PicoVNA calibration and certificate with data C0047 Recalibration of standard calibration kit C0048 Recalibration of premium calibration kit C0050 Remeasurement of check standard</p>	
<p>PQ186 Network Metrology Training Kit PQ189 Network Metrology Training PCA</p>	
<p>PQ187 Network Metrology Leader Standard Kit PQ188 Network Metrology Leader Premium Kit</p>	

See overleaf for further optional RF and Microwave accessories including attenuators, cables and adaptors.

Ordering information

Order code	Description	USD*	EUR*	GBP*	Order code	Description	USD*	EUR*	GBP*
PQ111	PicoVNA 106 6 GHz vector network analyzer	6535	5555	4585	TA431	CHK-NON-F Noninsertable check standard SMA(f-f)	859	729	599
PQ112	PicoVNA 108 8.5 GHz vector network analyzer	8845	7505	6205	MI030	BNC-BNC cable 1 m	14	12	10
TA336	Standard 8.5 GHz flexible test lead, male port, N(m)-SMA(m)	309	259	215	TA170	Adaptor 18 GHz 50 Ω SMA(m-f)	23	20	17
TA337	Standard 8.5 GHz flexible test lead, female port, N(m)-SMA(f)	309	259	215	TA314	Adaptor 18 GHz 50 Ω SMA(f)-N(m)	125	105	85
TA338	Premium 8.5 GHz flexible test lead, male port, N(m)-PC3.5(m)	809	689	569	TA262	Attenuator 10 dB 10 GHz 50 Ω SMA(m-f)	85	71	59
TA339	Premium 8.5 GHz flexible test lead, female port, N(m)-PC3.5(f)	809	689	569	TA173	Attenuator 20 dB 10 GHz 50 Ω SMA(m-f)	85	71	59
TA342	ADA-STD-MM Standard test port adaptor SMA(m-m)	77	66	54	TA181	Attenuator 3 dB 10 GHz 50 Ω SMA(m-f)	85	71	59
TA343	ADA-STD-FF Standard test port adaptor SMA(f-f)	77	66	54	TA261	Attenuator 6 dB 10 GHz 50 Ω SMA(m-f)	85	71	59
TA357	ADA-STD-FM Standard within series adaptor SMA(f-m)	77	66	54	TA265	Precision sleeved coaxial cable 30 cm 1.3 dB at 13 GHz	73	62	51
TA340	ADA-PREM-MM Premium test port adaptor PC3.5(m-m)	155	129	109	TA312	Precision sleeved coaxial cable 60 cm 2.2 dB at 13 GHz	73	62	51
TA341	ADA-PREM-FF Premium test port adaptor PC3.5(f-f)	155	129	109	TA358	Dual-break torque wrench N-type 1 N·m (8.85 in·lb)	215	179	149
TA354	ADA-PREM-FM Premium within series adaptor PC3.5(f-m)	155	129	109	TA356	Dual-break torque wrench SMA/PC3.5/K, 1 N·m (8.85 in·lb)	215	179	149
TA344	SOLT-STD-M Standard 8.5 GHz SOLT calibration kit, SMA(m)	519	439	369	CC046	Calibration certificate and data for PicoVNA	369	319	259
TA345	SOLT-STD-F Standard 8.5 GHz SOLT calibration kit, SMA(f)	519	439	369	CC047	Calibration for SOLT-STD-M or SOLT-STD-F	109	95	78
TA346	SOLT-PREM-M Premium 8.5 GHz SOLT calibration kit, PC3.5(m)	859	729	599	CC048	Calibration for SOLT-PREM-M or SOLT-PREM-F	159	135	109
TA347	SOLT-PREM-F Premium 8.5 GHz SOLT calibration kit, PC3.5(f)	859	729	599	CC050	Calibration for CHK-INS-MF or CHK-NON-F	159	135	109
TA430	CHK-INS-MF Insertable check standard SMA(m-f)	859	729	599					

UK global headquarters:

Pico Technology
James House
Colmworth Business Park
St. Neots
Cambridgeshire
PE19 8YP
United Kingdom

☎ +44 (0) 1480 396 395
✉ sales@picotech.com

North America regional office:

Pico Technology
320 N Glenwood Blvd
Tyler
TX 75702
United States

☎ +1 800 591 2796
✉ sales@picotech.com

Asia-Pacific regional office:

Pico Technology
Room 2252, 22/F, Centro
568 Hengfeng Road
Zhabei District
Shanghai 200070
PR China

☎ +86 21 2226-5152
✉ pico.asia-pacific@picotech.com

* Prices correct at the time of publication. Sales taxes not included. Please check www.picotech.com for the latest prices before ordering. Errors and omissions excepted.

Pico Technology is an internationally registered trade mark of Pico Technology Ltd. PicoVNA is a registered trade mark of Pico Technology Ltd. MM084.en-11. Copyright © 2017–2021 Pico Technology Ltd. All rights reserved.

www.picotech.com



Pico Technology



@LifeAtPico



@picotechnologyLtd



Pico Technology



@picotech