

REVISIONS			
REV	DESCRIPTION	DATE	APPROVED
-	-	-	-

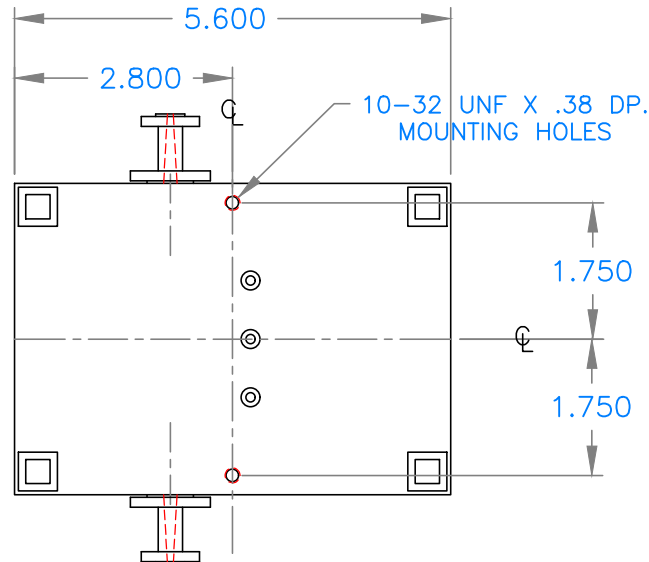
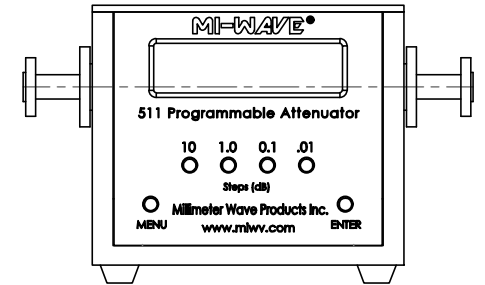
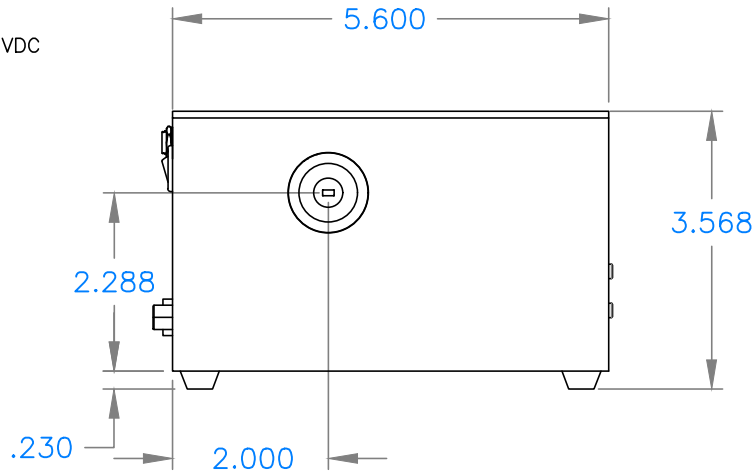
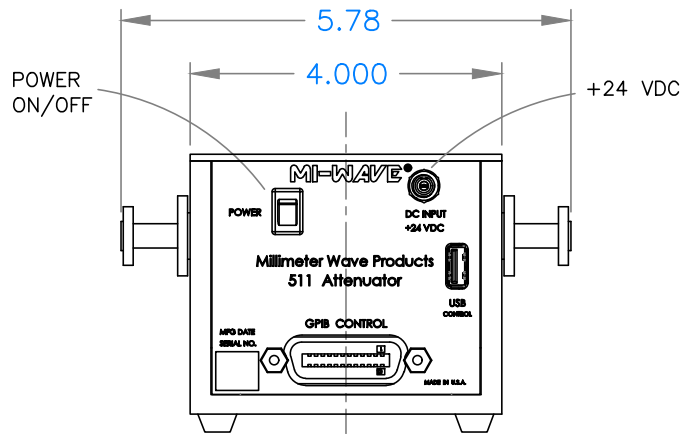

ALL DIMENSIONS REF ONLY

QTY	PART NUMBER	OUTLINE DESCRIPTION		ITEM
		Mi-Wave Millimeter Products Inc.		
UNLESS OTHERWISE SPECIFIED ALL SURFACES $\sqrt{32}$		THIRD ANGLE PROJECTION		
DIMENSIONS ARE IN INCHES TOLERANCES ARE: DECIMALS: .1234 +/- .0005 .123 +/- .005 .12 +/- .01 ANGLES: +/- .5 DEGREES		DRAFTING: JV APPROVED: M.S. DATE: 7-17-18		
ALL THREADS TO BE 2A OR 2B		SHEET NO. 1	OF 1	
REF DWG# ---		SIZE A	DWG NO 25445	REV -