

| REVISIONS | | | |
|-----------|-------------|------|----------|
| REV | DESCRIPTION | DATE | APPROVED |
| -- | -- | -- | -- |

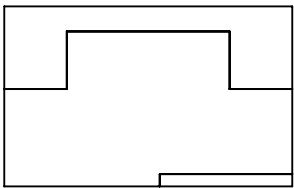

MOUNTING HOLES

2X ϕ .089 ∇ .275
4-40 UNC ∇ .250

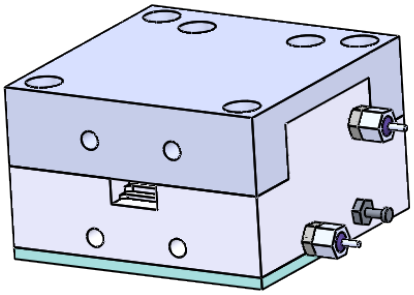

WR-28
UG-599
FLANGE
PATTERN

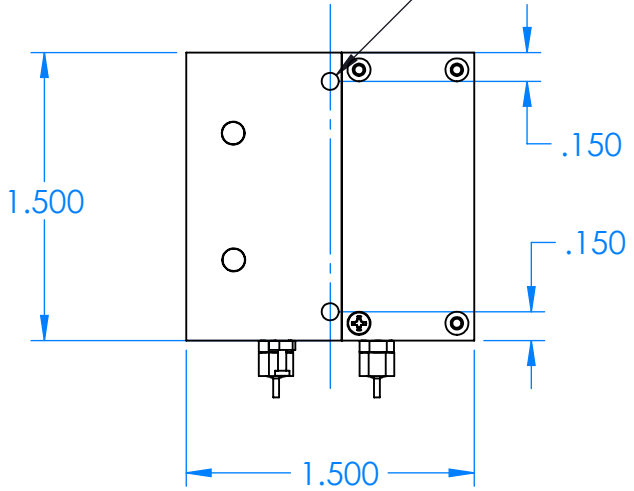
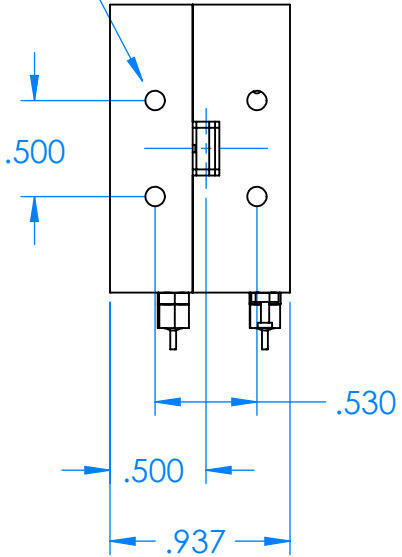
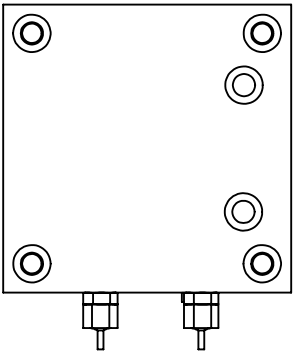

WR-28
UG-599
FLANGE
PATTERN

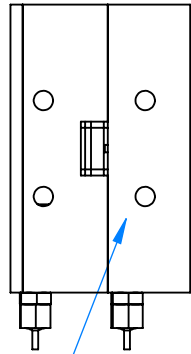

BIAS VOLTAGE

CONTROL VOLTAGE

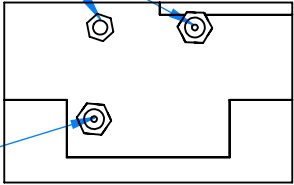

RECIPROCAL DEVICE

| | | | | | | |
|---|-------------------------------|----|----------|---|---------|--------------|
| DECIMALS: XXXX \pm .0005 XXX \pm .005 XX \pm .01 ANGLES: \pm .5 DEGREE THIRD ANGLE PROJECTION | DRAWN | CC | 10-21-21 | TITLE: Mi-Wave Millimeter Products Inc. SIZE DWG. NO. 900A_OUTLINE_26238 | REV | |
| | CHECKED | MS | 10-21-21 | | | |
| | ENG | LS | 10-21-21 | A SCALE: 1:1 | WEIGHT: | SHEET 1 OF 1 |
| | MATL: 6061 T6 ALUMINUM | | | | | |