



Lock-in Amplifier

Moku:Go User Manual

Moku:Go's digital Lock-in Amplifier supports dual-phase demodulation (XY/R θ) from DC to 20 MHz. It features an integrated 2-channel oscilloscope and data logger, enabling you to observe signals at up to 125 MSa/s and log data at up to 1 MSa/s. A PID controller can also be placed after the demodulation stage for phase-locked loop applications.





Table of Contents

Introduction	4
Principle of Operation	4
User Interface	5
Main Menu	6
Signal Input	7
Dual-Phase Demodulator	8
Filter Bandwidth and Time Constant	9
Rect-to-Polar Conversion Range	9
Outputs	10
Advanced Configuration	11
Demodulation	12
Internal	12
External (direct)	12
External (PLL)	13
None	13
Auxiliary Output	14
Aux Oscillator	14
Filtered Signal	15
Local Oscillator	15
PID Controller	16
Off	16
Main Output	16
Auxiliary Output	16
PID Controller	17
Probe Points	18
Oscilloscope	18
Data Logger	19
Additional Tools	20
File Manager	20
File Converter	21
Power Supply	22



Ensure Moku:Go is fully updated. For the latest information:

www.liquidinstruments.com



Introduction

Lock-in amplifiers are extremely versatile instruments used primarily to recover the magnitude and phase of weak oscillating signals in the presence of overwhelming noise. They are used in a vast range of applications including atomic physics, radio-frequency engineering, materials science, precision laser metrology, and many more.

Principle of Operation

Lock-in amplifiers work by demodulating an input signal $R \sin(\omega t + \phi)$ with a reference signal $\sin(\omega t)$.

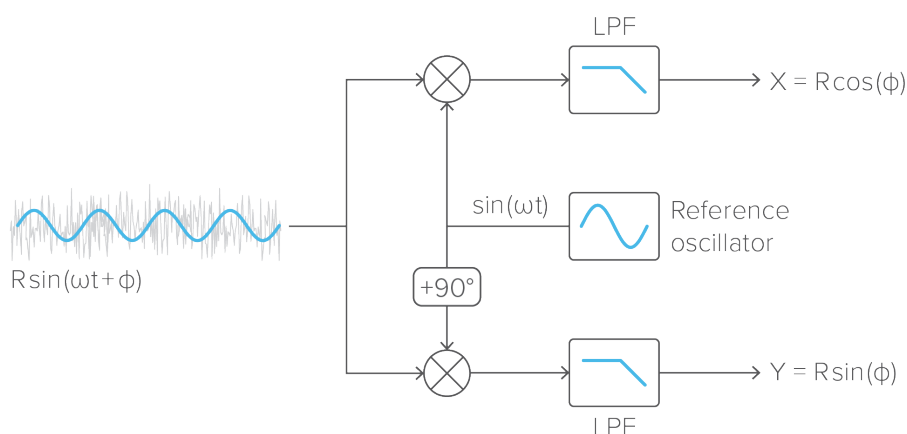

The demodulation process produces two spectral components: an *up-shifted* signal with a frequency equal to the *sum* of the input and reference signals, and a *down-shifted* signal with a frequency equal to the *difference* of the input and reference signals.

If the input and reference signals have the same frequency ω , then the down-shifted component will appear at DC, whereas the up-shifted component will appear at twice the input frequency with additive phase.

A low pass filter is used to attenuate the up-shifted signal and to suppress noise, the output of which is proportional to the amplitude of the input signal scaled by the cosine of the phase difference: $R \cos(\phi)$. In order to reconstruct the magnitude and phase of the input signal, it is necessary to demodulate it with two orthogonal references, sine and cosine, to produce in-phase (X) and quadrature (Y) components relative to the reference. This process is referred to as dual-phase demodulation and is a standard feature of all modern lock-in amplifiers.

With X and Y, the magnitude R and phase ϕ can be calculated as $R = \sqrt{X^2 + Y^2}$ and $\phi = \tan^{-1}(Y/X)$.



User Interface

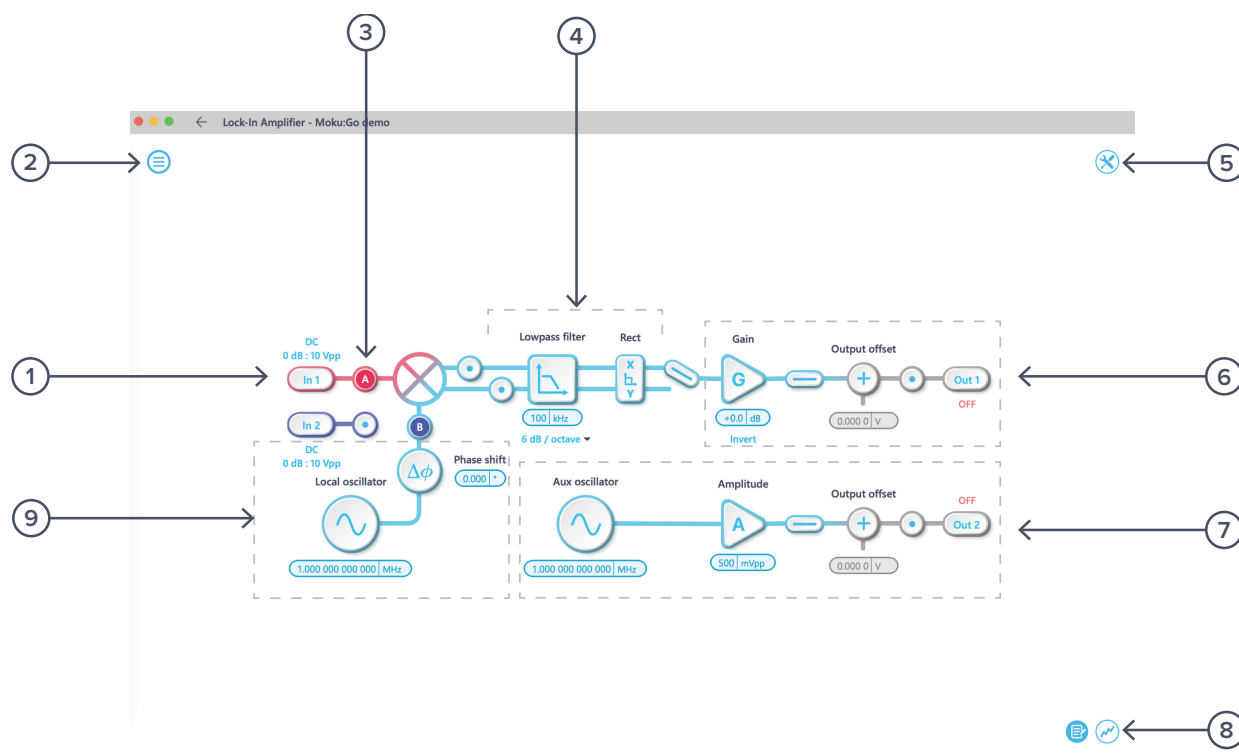

ID	Description	ID	Description
1	Input settings	6	Channel 1 output
2	Main menu	7	Channel 2 output
3	Probe point	8	Oscilloscope/Data Logger
4	Filter settings	9	Reference oscillator
5	Advanced configuration menu		



Main Menu

The **main menu** can be accessed by clicking the  icon, allowing you to:

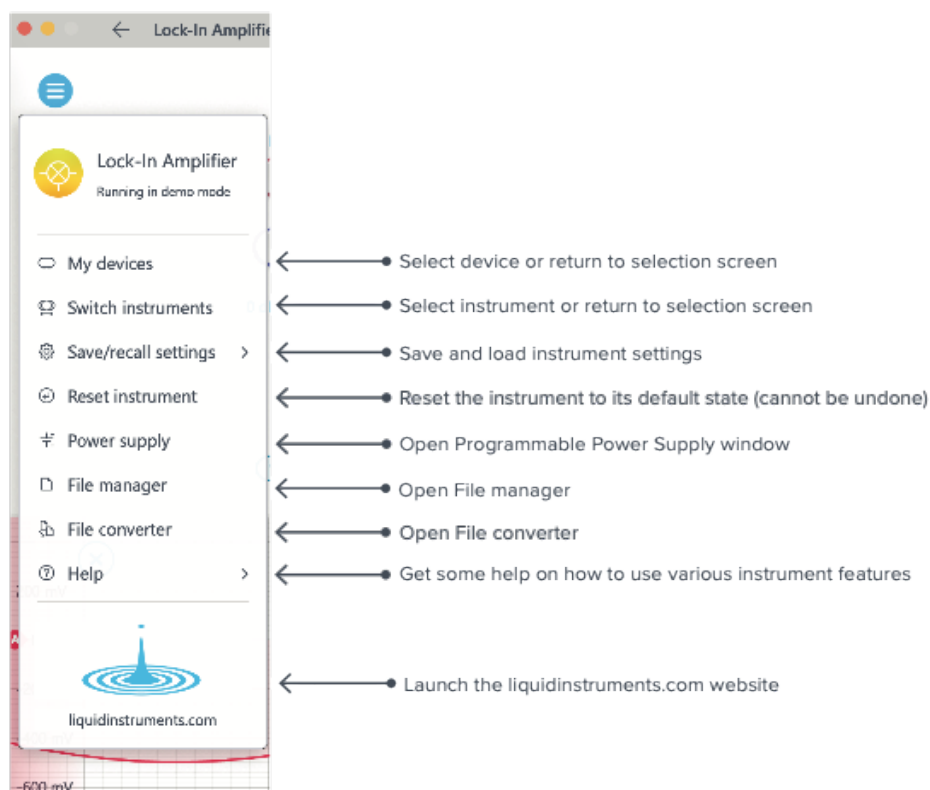



Signal Input

Click the **In 1** icon to configure the input settings for the signal input.

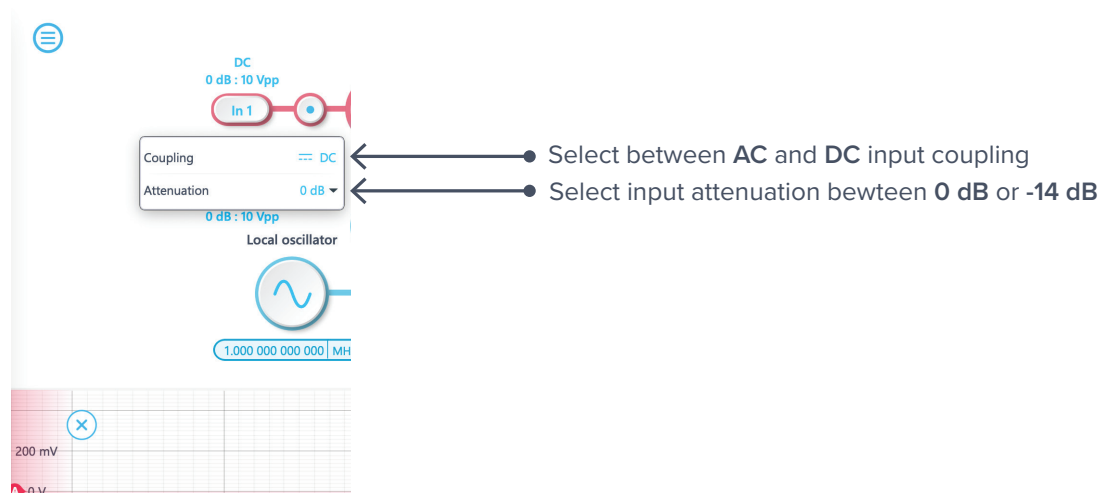



Dual-Phase Demodulator

Moku:Go's Lock-in Amplifier features a dual-phase demodulator with cascaded single pole low pass filters to attenuate the second harmonic and suppress noise in the in-phase and quadrature components.

- Select between **6, 12, 18, or 24 dB / octave** low pass filter slopes.
- Select between rectangular (X/Y) and polar (R/ θ) coordinate modes.
- View the demodulated in-phase and quadrature signals prior to the low pass filters using probe points.
- Select which demodulated signal to route to the output. Note: your options depend on how the Lock-in Amplifier is configured.

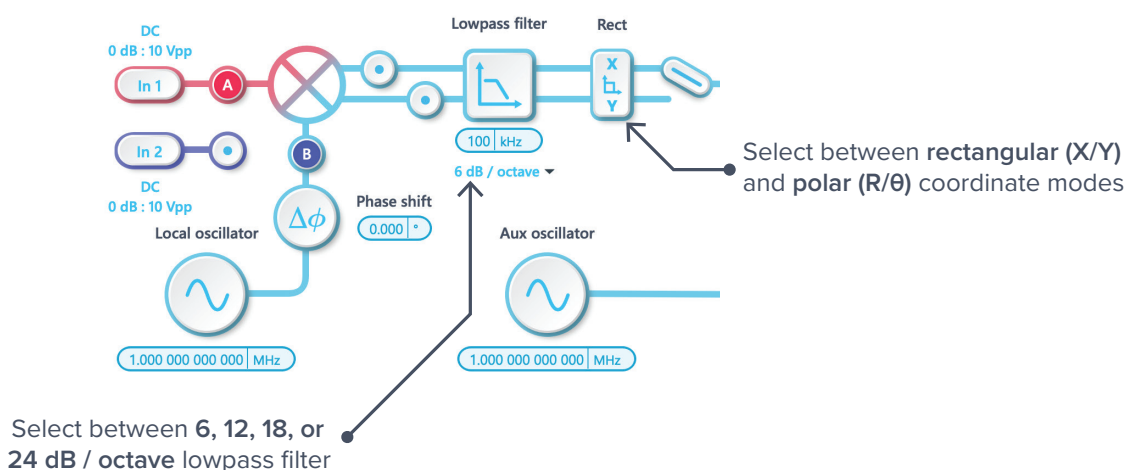

Rectangular (or Cartesian) coordinate mode measures the input signal with respect to a specific quadrature of the reference signal. When combined with a PID controller, Cartesian mode can be used to perform laser frequency stabilization.

Polar coordinate mode measures the amplitude and phase of the input signal with respect to the reference signal. Polar mode is not available when using external references in straight-through mode due to the lack of a quadrature demodulation signal.



Filter Bandwidth and Time Constant

The filter bandwidth and time constant are equivalent representations for the width of the filter passband. They can be converted using the following equation:

$$\text{Time Constant} = \frac{1}{2\pi \times \text{Filter Bandwidth}}$$

Rect-to-Polar Conversion Range

In polar mode, the rectangular-to-polar conversion range allows you to select the signal processing range for optimized system performance. Three ranges are available: 2 V_{pp}, 7.5 mV_{pp}, and 25 μV_{pp}. The smallest range which can accommodate your signal without saturating should be used. For example, if the measured signal has an amplitude of 1 mV_{pp}, the 7.5 mV would be the most suitable range; if a signal has an amplitude of 1 V_{pp}, the 2 V_{pp} range would be the most suitable range.

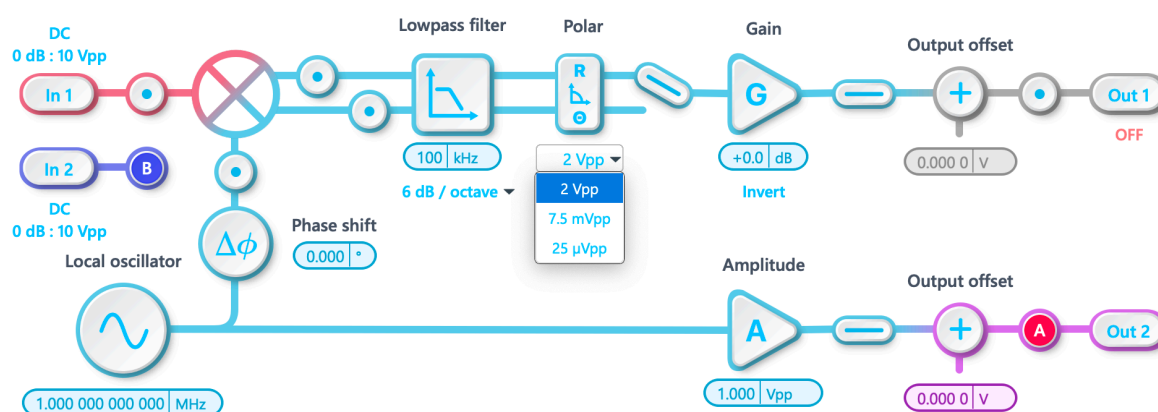



Outputs

Configure the gain / amplitude and voltage offset of the two output channels. Enable / disable either output channel by clicking the **Out 1** and **Out 2** icons. View the signal at the output of each channel using the probe points

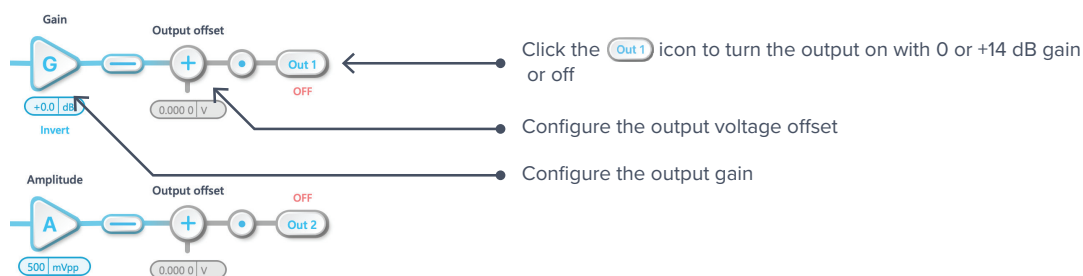



Advanced Configuration

The Lock-in Amplifier's digital signal processing layout can be rapidly re-configured to suit different applications. Access the advanced configuration menu using the  icon at the top right corner of the interface.

- Select between internal, external (straight-through), or external (phase-locked) demodulation references. Alternatively, you can bypass the demodulation by selecting “none”.
- Configure the auxiliary output to generate an independent aux oscillator with adjustable frequency and amplitude, the second output from the demodulator (e.g., generate voltage signals proportional to R and θ from outputs 1 and 2 respectively), or the local oscillator (available in internal demodulation mode only).
- A PID controller can be added to the main output (channel 1) or the auxiliary output (only available when generating a second filtered signal from the auxiliary output).

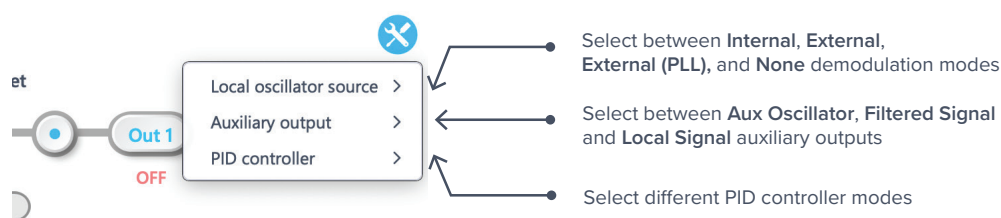



Demodulation

The demodulation mode determines which reference signal is used to demodulate the input signal.

Internal

The input signal can be demodulated with an internally generated reference signal. This local oscillator is derived from Moku:Go's internal clock and thus shares the same timebase. The frequency range of the internal reference is 1 MHz to 20 MHz.

External (direct)

The input signal can be demodulated by a direct external reference, permitting the use of non-sinusoidal demodulation of the input signal. This can be used to measure correlation or to recover specific components of complex input signals.

The arbitrary nature of direct external reference signals means that they cannot be used to perform dual-phase (orthogonal) demodulation of the input signal. This prevents external (direct) demodulation mode from being used to measure Y , R , and θ since only one quadrature can be interrogated.



External (PLL)

Dual-phase demodulation of the input signal with an external reference can be performed using phase-locked external reference mode, which constructs two orthogonal reference signals phase-locked to the external reference. This mode uses a digitally implemented phase-locked loop to track the phase of the external reference with a user selectable bandwidth, allowing it to generate phase-locked in-phase and quadrature sinusoids at the same frequency, with adjustable phase.

External (PLL) mode enables the Lock-in Amplifier to recover information in all quadrants (X/Y and R/ θ) without requiring Moku:Go to share the same source clock as the external system.

The phase-locked loop will automatically lock to the strongest harmonic of the external reference in the range of 100 Hz to 20 MHz in auto mode. Tracking frequencies between 100 Hz and 20 MHz can be manually entered. The reacquire button can be used to re-lock to the external reference.

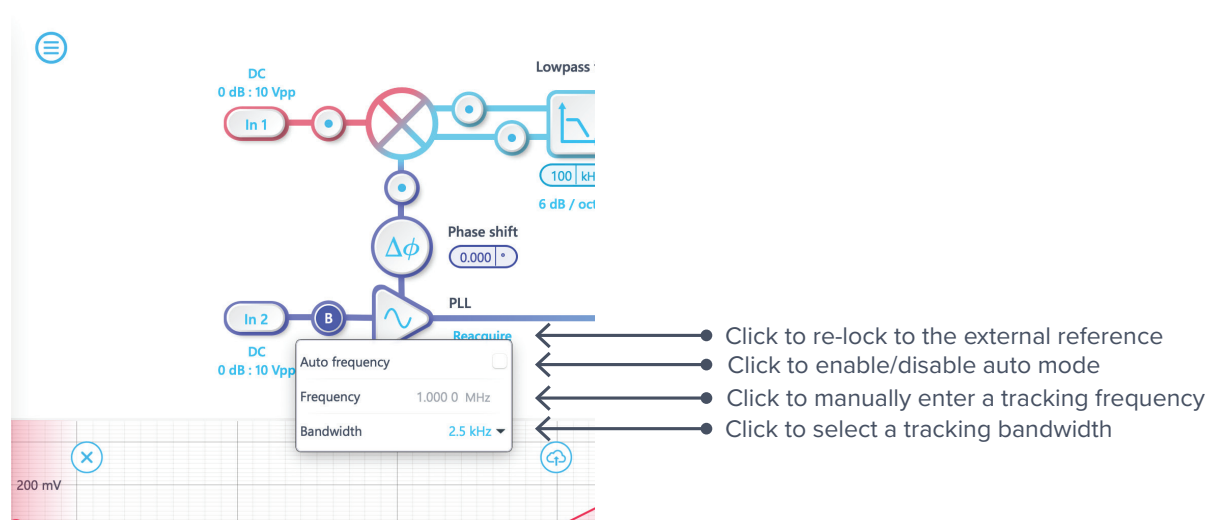

None

The demodulation step can be bypassed by selecting “none”. This enables modulation-free locking techniques such as DC locking, fringe-side locking, and tilt locking.



Auxiliary Output

Moku:Go's second output can be configured to generate an additional auxiliary voltage signal.

Aux Oscillator

Aux oscillator mode allows you to generate a sinusoidal signal with independently configurable frequency, amplitude, and voltage offset. The frequency can be adjusted from 1 mHz to 20 MHz and the amplitude range (amplitude + offset) is 5 V_{pp} with 1 mV resolution.

The generated waveform shares the same timebase as the rest of the instrument. When used with internal demodulation, this mode can be used to stimulate a system at one frequency and demodulate at a different frequency, for example in wavelength modulation spectroscopy where it is necessary to demodulate harmonics of the input signal.

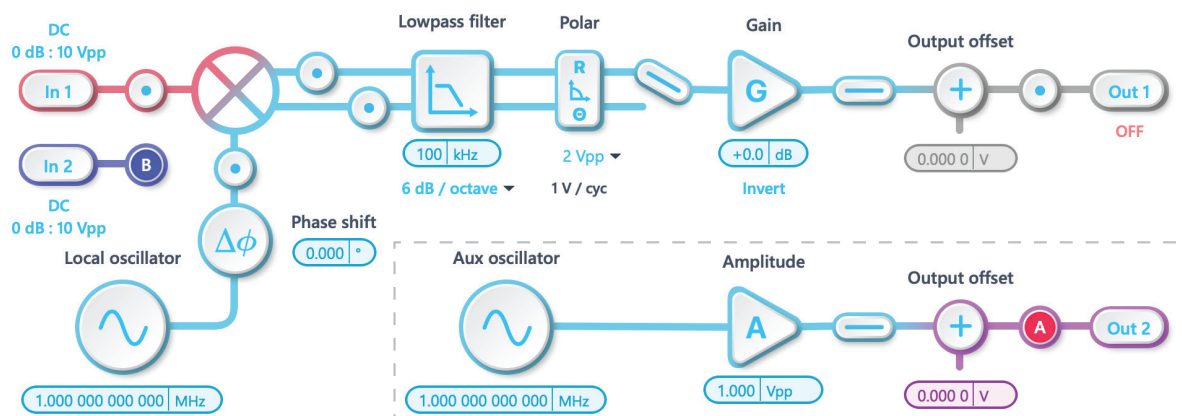

The **aux oscillator** auxiliary output mode allows you to generate a local oscillator signal with independent frequency, amplitude, and vertical offset control



Filtered Signal

The second output of the dual-phase demodulator can be routed to Moku:Go's second output channel to produce a voltage signal proportional to Y or θ .

This mode can be used to record both in-phase and quadrature at the same time using probe points.

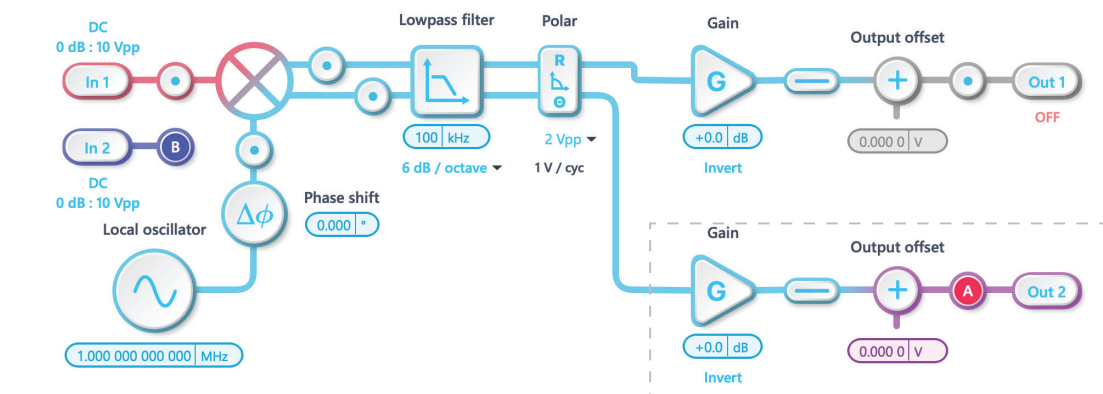

The **filtered signal** auxiliary output mode generates a second voltage signal proportional to the second low pass filtered output of the demodulator

Local Oscillator

The internal reference used to demodulate the input signal can be used to generate a sinusoidal waveform at the same frequency with configurable amplitude and voltage offset.

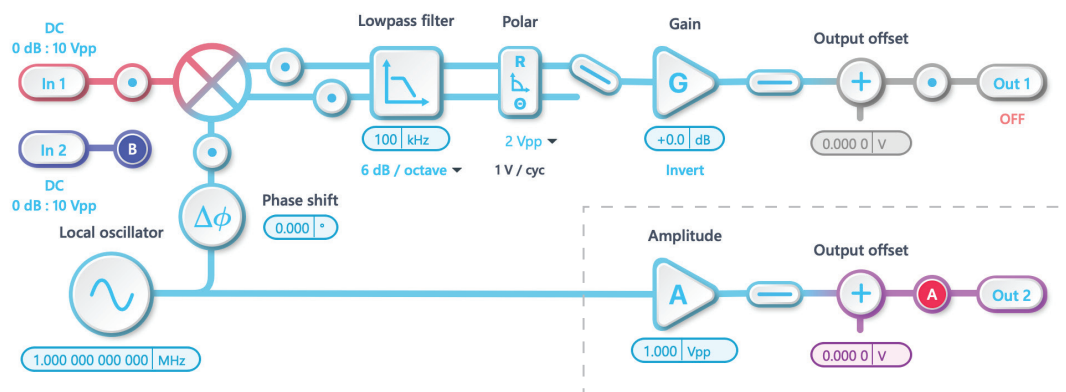

The **local oscillator** auxiliary output mode will generate a local oscillator at the same frequency as the demodulation waveform with full amplitude and vertical offset control



PID Controller

Moku:Go's Lock-In Amplifier can be used to control an external system by acting as both a sensor and controller using a dedicated PID controller. The PID controller's frequency dependent gain can be easily configured to satisfy the stability requirements of the control system.

Note: The Lock-in Amplifier can only implement a single PID controller at a time. This means that when the instrument's auxiliary output is configured to generate a voltage signal proportional to the Y or θ , the PID controller can be used on *either* X/R or Y/θ , but not both.

Off

Turns off the full PID controller. A flat gain can still be configured.

Main Output

Adds a PID controller to the main output.

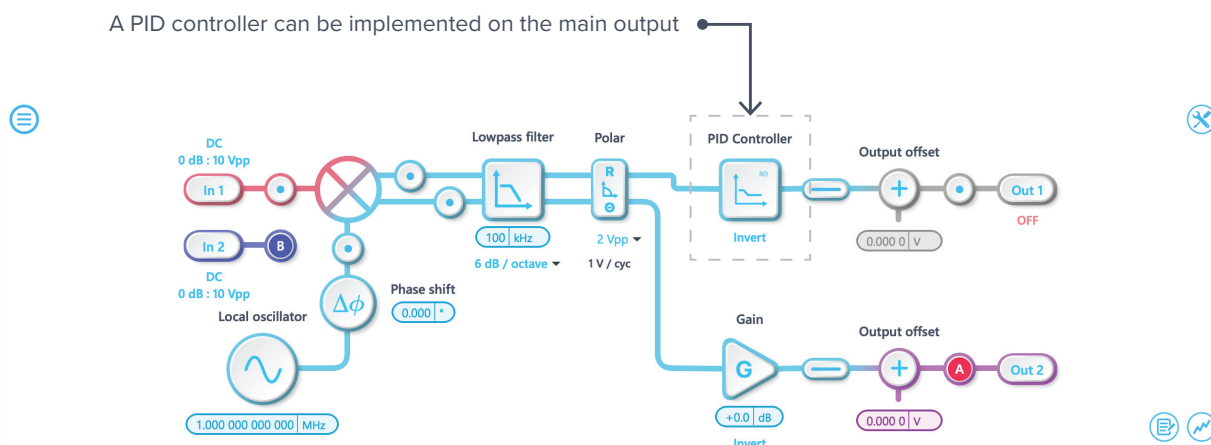

Auxiliary Output

Adds a PID controller to the auxiliary output.

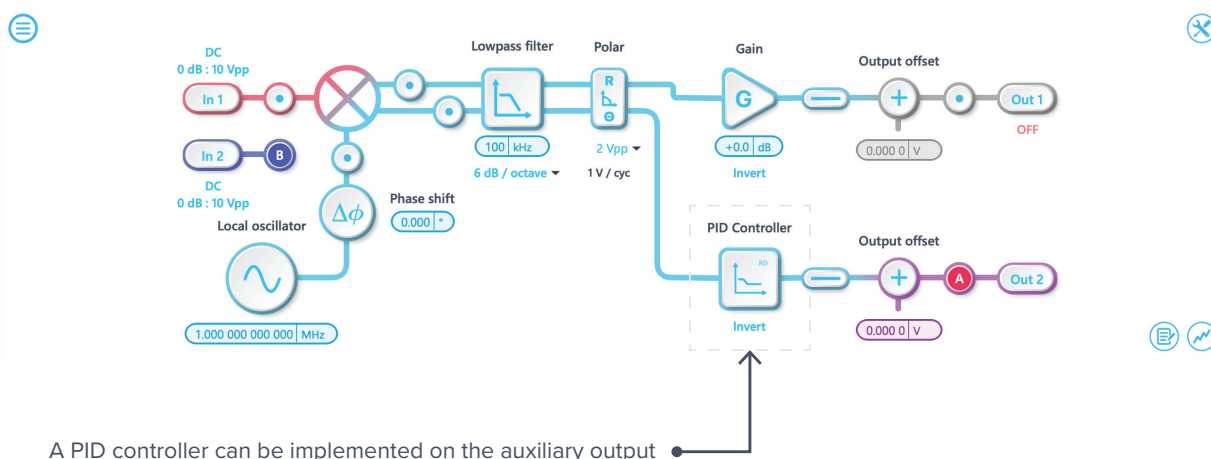



PID Controller

The PID controller provides full control over proportional, integral, and derivative gain profiles with saturation levels available for the integral and derivative controllers. The PID's transfer function is updated in real-time.

The gain of each control stage can be adjusted individually. The following example shows a proportional-plus-integral controller with a unity gain crossover frequency at 310 Hz. It is possible to maintain this crossover frequency with the proportional gain by using the **overall gain** control on the left, which will shift the entire gain profile up and down. More details about the PID controller can be found in Moku:Go's PID Controller manual.

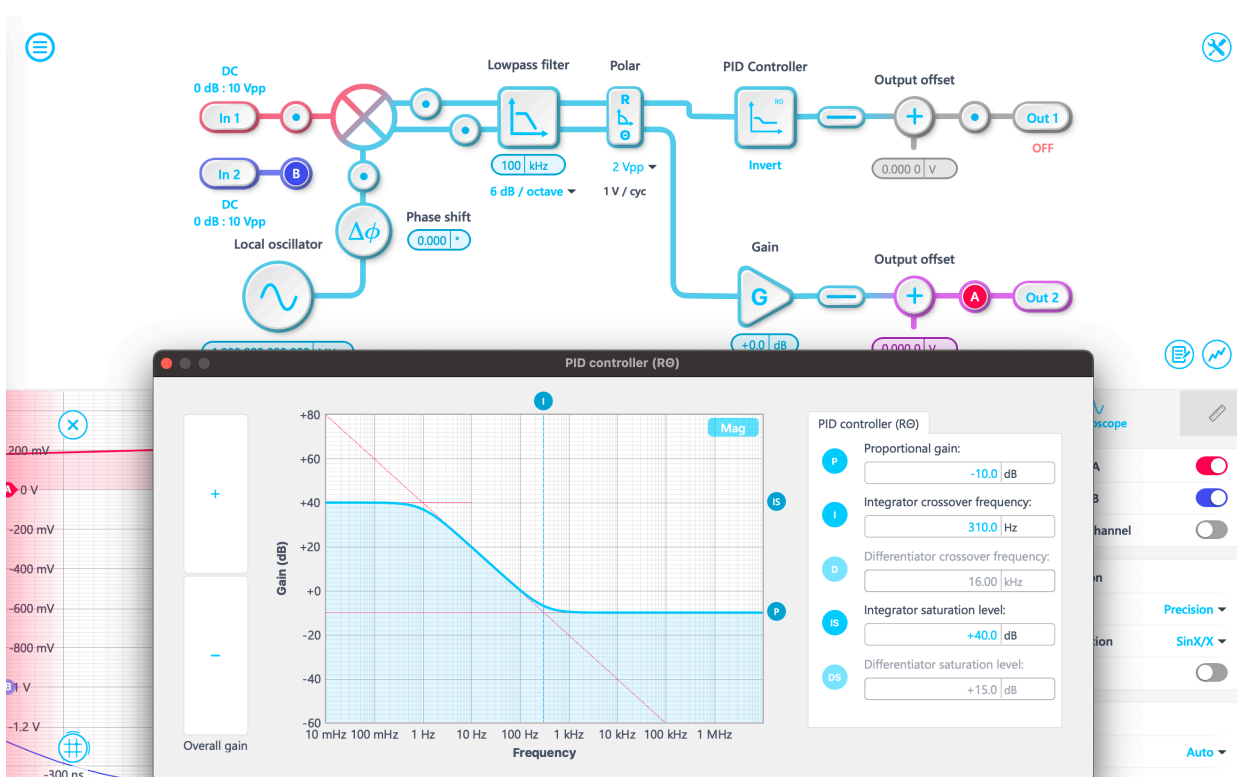



Probe Points

Moku:Go's Lock-in Amplifier has an integrated oscilloscope and data logger that can be used to probe the signal at various stages of the demodulation process. The probe points can be added by clicking the  icon. Up to four probe points can be added to monitor or log data.

Oscilloscope

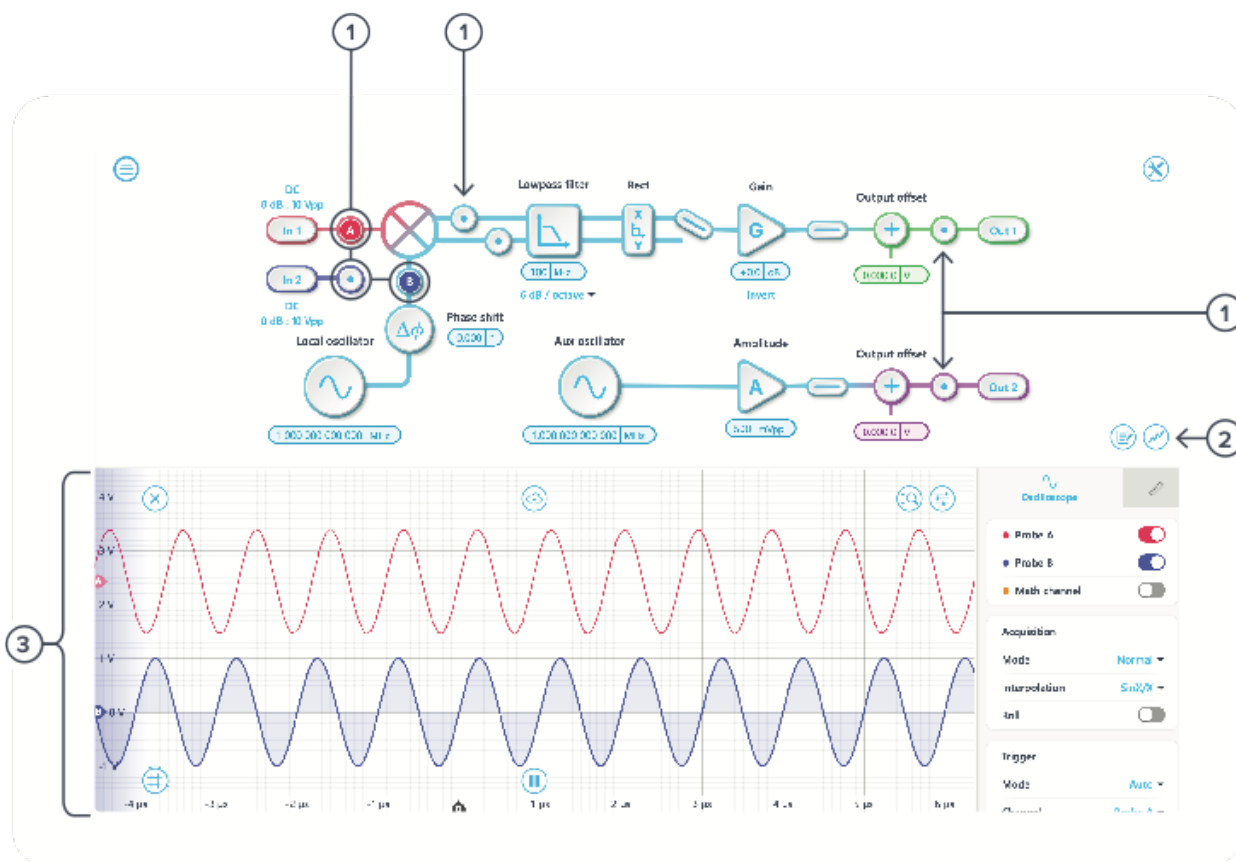

ID	Parameter	Description
1	Probe points	Click to place the probe point. You can enable up to two probe points at a time.
2	Oscilloscope/Data Logger toggle	Toggle between built-in Oscilloscope or Data Logger
3	Oscilloscope	Refer to the Moku:Go's Oscilloscope manual for the details



Data Logger

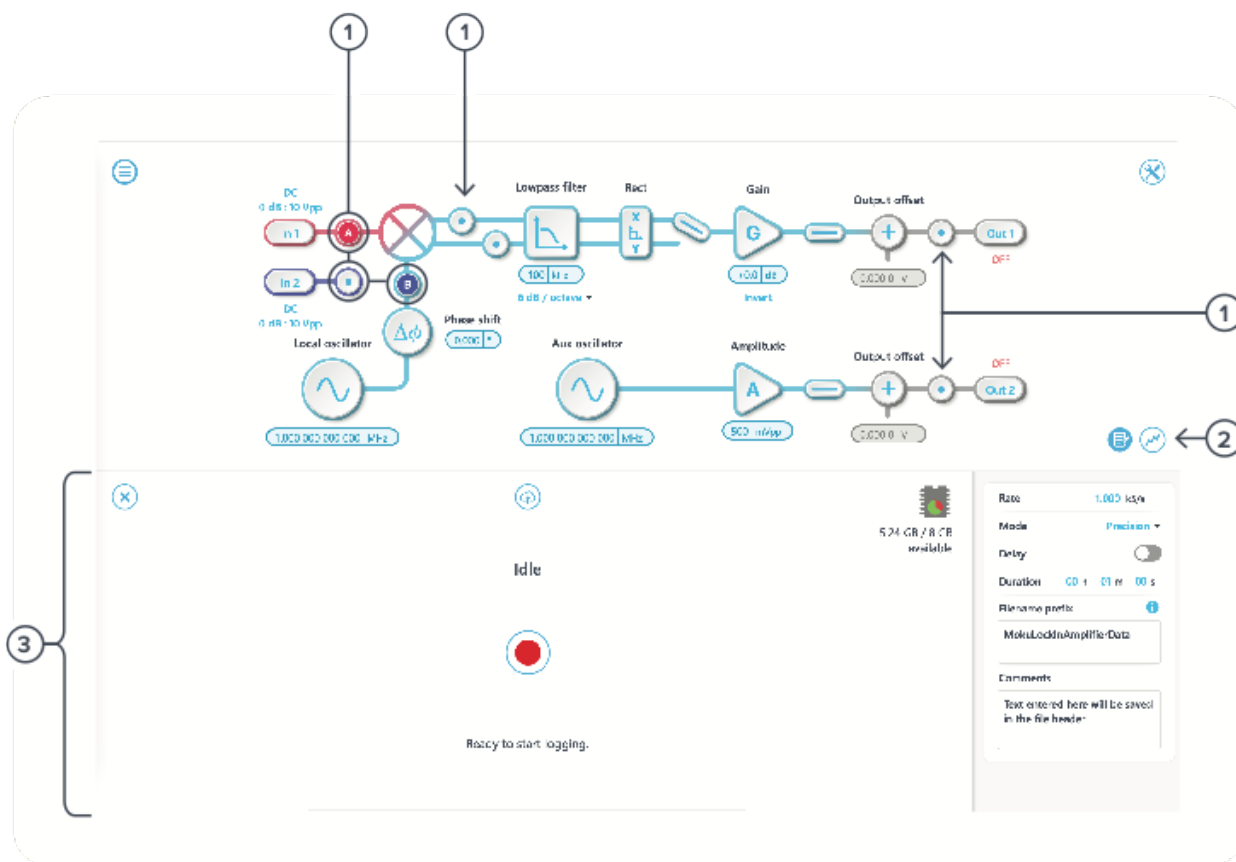

ID	Parameter	Description
1	Probe points	Click to place the probe point. You can enable up to four probe points at a time.
2	Oscilloscope/data logger toggle	Toggle between built-in oscilloscope or data logger
3	Data Logger	Refer to the Moku:Go's Data Logger manual for the details



Additional Tools

Moku:Go's app has two built-in file management tools: file manager and file converter. The file manager allows users to download the saved data from Moku:Go to a local computer, with optional file format conversion. The file converter converts the Moku:Go's binary (.li) format on the local computer to either .csv, .mat, or .npy format.

File Manager

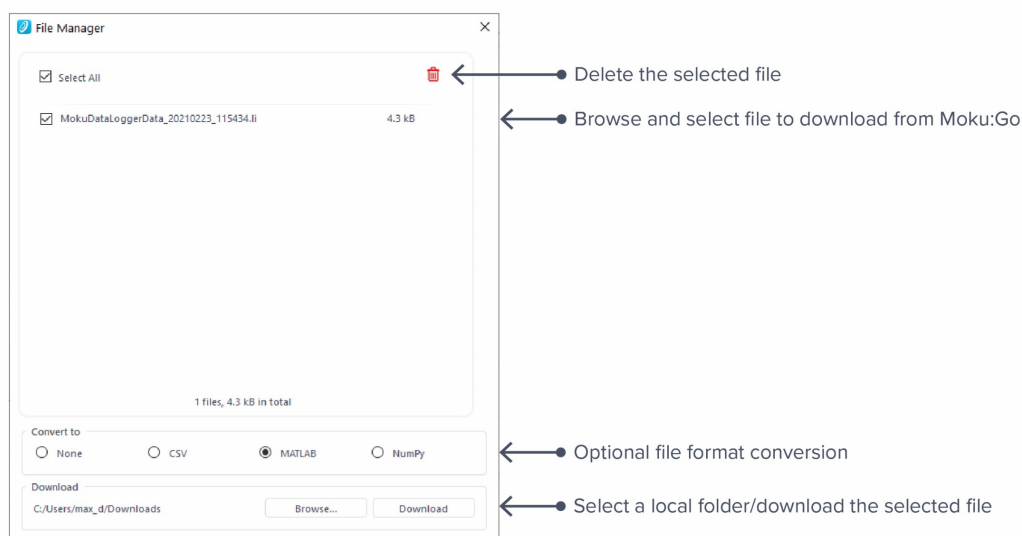

Once a file is transferred to the local computer, a  icon shows up next to the file.



File Converter

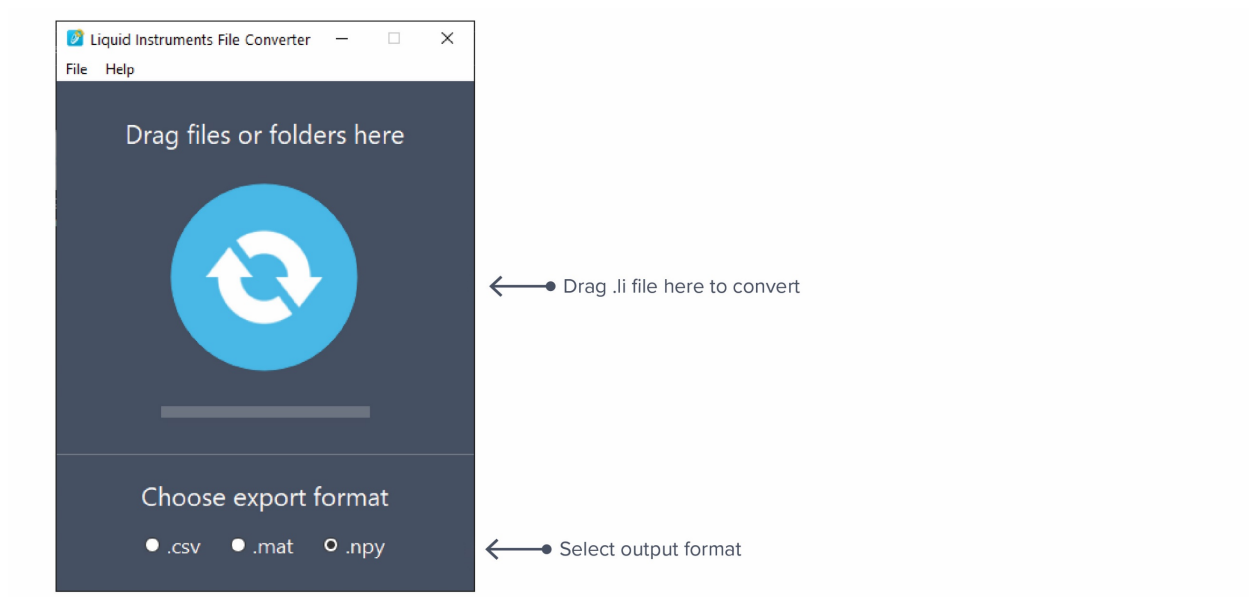

The converted file is saved in the same folder as the original file.

Liquid Instruments File Converter has the following menu options:

Options	Shortcut	Description
File		
• Open file	Ctrl+O	Select a .li file to convert
• Open folder	Ctrl+Shift+O	Select a folder to convert
• Exit		Close the file converter window
Help		
• Liquid Instruments website		Access Liquid Instruments website
• Report an issue		Report bug to Liquid Instruments
• About		Show app version, check update, or license information



Power Supply

Moku:Go's power supply is available on M1 and M2 models. M1 features a 2-channel power supply, while M2 features a 4-channel power supply. The power supply control window can be accessed in all instruments under the main menu.

The power supply operates in two modes: **constant voltage (CV)** or **constant current (CC)** mode. For each channel, the user can set a current and voltage limit for the output. Once a load is connected, the power supply operates either at the set current or set voltage, whichever comes first. If the power supply is voltage limited, it operates in the CV mode. If the power supply is current limited, it operates in the CC mode.

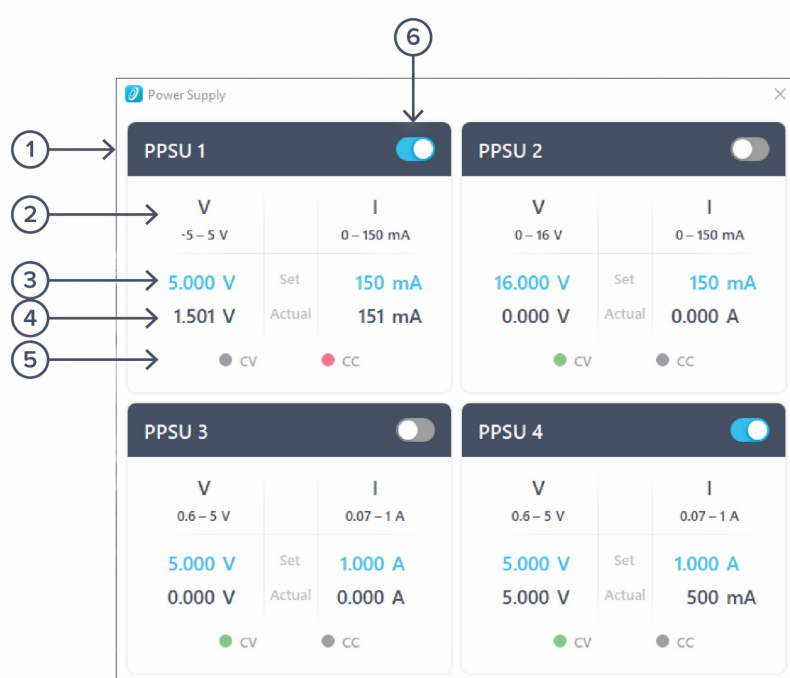

ID	Function	Description
1	Channel name	Identifies the power supply being controlled
2	Channel range	Indicates the voltage/current range of the channel
3	Set value	Click the blue numbers to set the voltage and current limit
4	Readback numbers	Voltage and current readback from the power supply, the actual voltage and current being supplied to the external load
5	Mode indicator	Indicates if the power supply is in CV (green) or CC (red) mode
6	On/Off Toggle	Click to turn the power supply on and off



Ensure Moku:Go is fully updated. For the latest information:

www.liquidinstruments.com