

FURNITURE HANDLES & KNOBS
MOBİLYA KULPLARI VE DÜĞMELER

cebi®

□ always
the best
solutions



2025-2026
EXPRESS
CATALOGUE

ART DEKORATİF ÜRÜNLER TASARIM A.Ş.

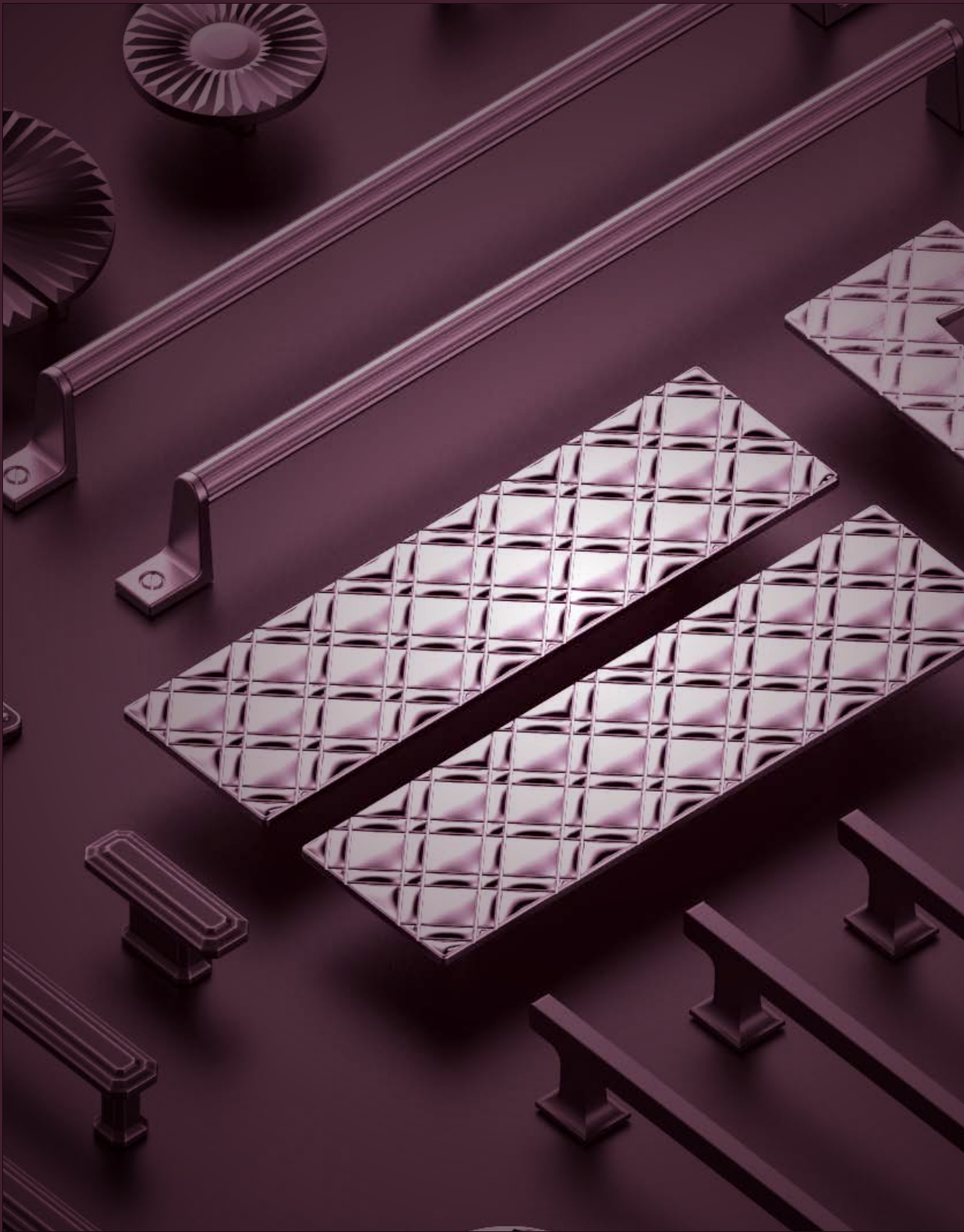

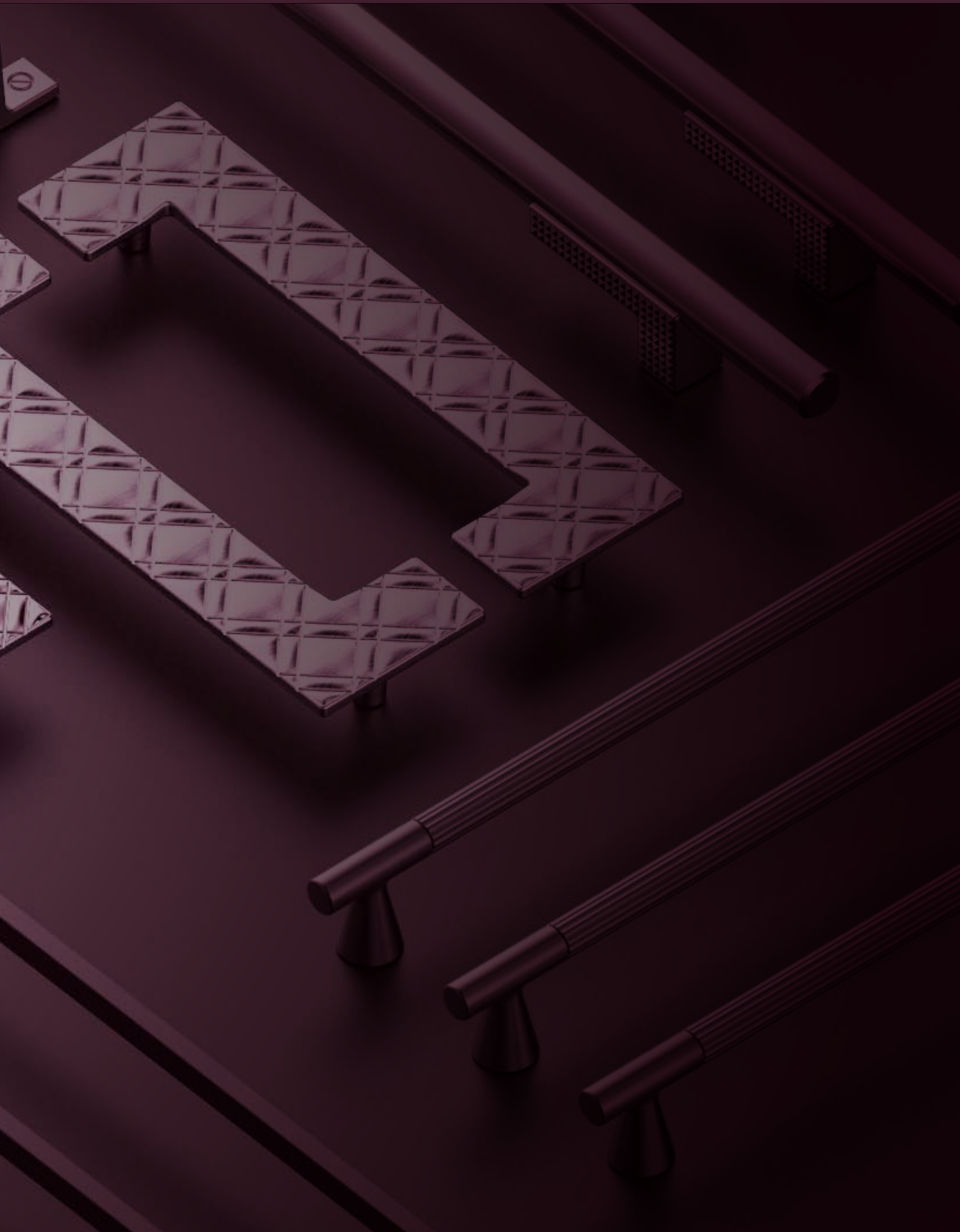

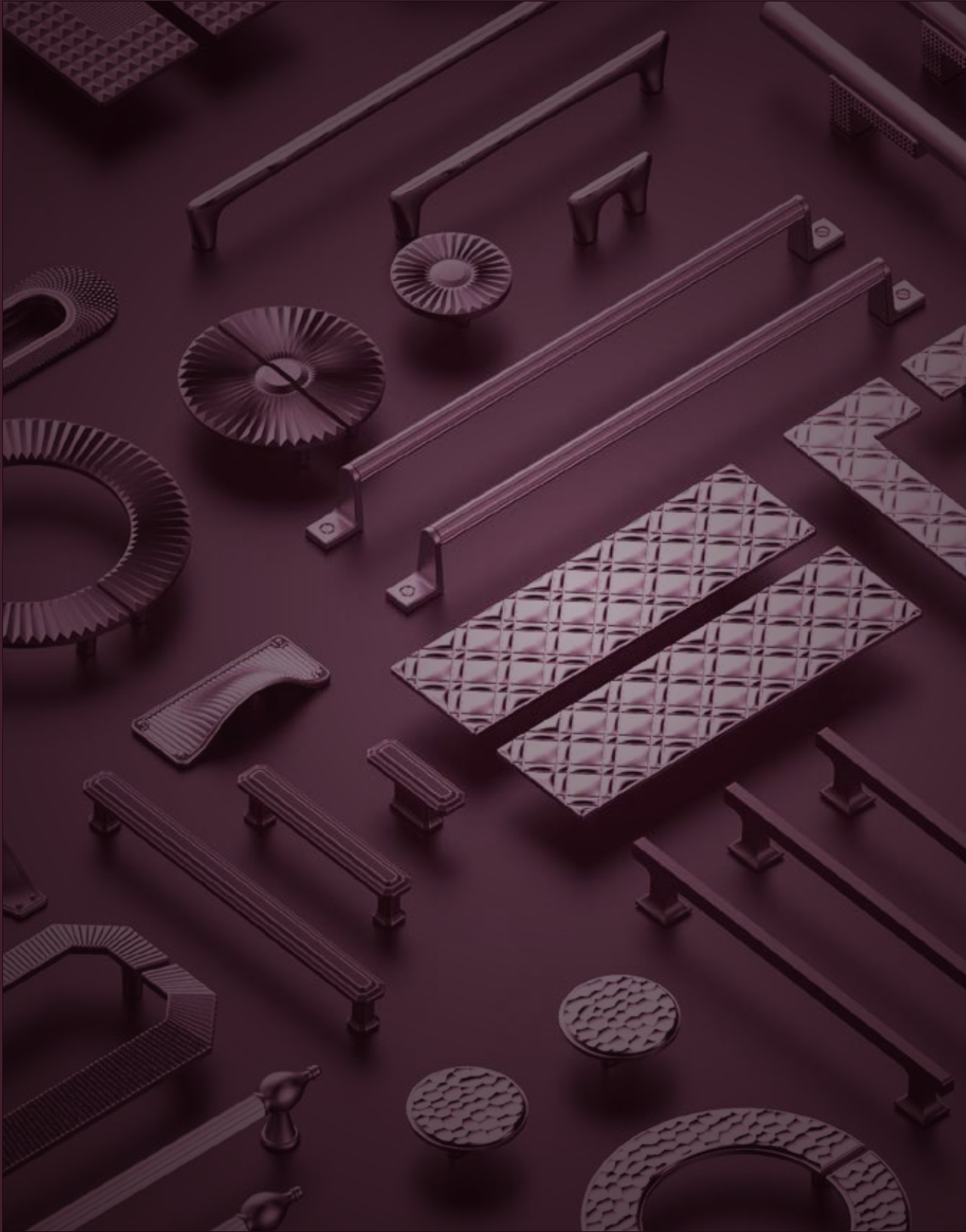

Discover new passions

ABOUT US

Çebi carries its signature into living spaces from 1979 to today with the theme of passion and perfection that nourishes its original and refined designs.

As one of Türkiye's leading companies in its field, Çebi defines a sophisticated lifestyle in its stylish collections with timeless, brilliant designs. In order to take its products to the highest possible level, it continuously carries out design and collection studies by taking functionality and ergonomics into consideration.

Adopting an innovative approach, Çebi creates designs in Hinges, Locks, and Bathroom Accessories in addition to its designs in furniture and door handle groups. Çebi does not offer "just design" to living spaces and projects. It aims to meet all your decorative needs, from furniture to doors, and from doors to bathrooms.

The symbols of Çebi's professionalism — mastery in shaping, coating quality and durability, high surface quality, and perfect surface smoothness — carry its collections and products far beyond "just design." From raw material selection to production processes, it preserves environmental sensitivity at every stage by using renewable energy.

Under the roof of Art Metal Group, the Çebi brand is now stronger!

CebiDesign, Europe's largest production base in its field, has joined the ART Metal Group, one of the leading players in the metal industry. This strategic step creates significant synergy in the sector by combining CebiDesign's innovative approach with ART Metal Group's strong experience and vision. With new investments and expanded production capacity, the brand further advances its sector leadership.

HAKKIMIZDA

Çebi özgün ve rafine tasarımlarını besleyen tutku ve kusursuzluk temasıyla imzasını 1979'dan bugüne yaşam alanlarına taşıyor.

Türkiye'nin alanında önde gelen firmalarından olan Çebi stil sahibi koleksiyonlarında sofistike yaşam tarzını zamansız parlak tasarımlarla tanımlıyor. Ürünlerini mümkün olan en üst seviyeye taşımak için fonksiyonelliği ve ergonomiyi dikkate alarak tasarım ve koleksiyon çalışmalarını aralıksız sürdürüyor.

Yenilikçi yaklaşımı benimseyen Çebi, mobilya ve kapı kolu gruplarındaki tasarımlarına ek olarak Menteşe, Kilit ve Banyo Aksesuarlarında da tasarımlar yapmaktadır. Çebi, yaşam alanlarına ve projelere "sadece tasarım" sunmuyor. Mobilyadan kapıya, kapıdan banyoya bütün dekoratif ihtiyaçlarınızı karşılamayı amaçlamaktadır.

Çebi profesyonelliğinin simgeleri olan, şekillendirmedeki ustalık, kaplama kalitesi ve dayanıklılık, yüksek yüzey kalitesi ve mükemmel yüzey pürüzsüzlüğüyle koleksiyonlarını ve ürünlerini, "sadece tasarımın" çok ötesine taşıyor. Hammadde seçiminden üretim süreçlerine kadar her aşamada çevre duyarlılığını koruyarak yenilenebilir enerjiler kullanıyor.

Art Metal Group çatısı altında Çebi markası artık daha güçlü! Faaliyet alanında Avrupa'nın en büyük üretim üssü olan CebiDesign, metal sektörünün lider oyuncularından ART Metal Group çatısı altına katıldı. Bu stratejik adım, CebiDesign'in inovatif yaklaşımını ART Metal Group'un güçlü deneyimi ve vizyonuyla birleştirerek sektörde önemli bir sinerji yaratıyor. Yeni yatırımlar ve genişleyen üretim kapasitesi ile marka, sektör liderliğini daha da ileriye taşıyor.





TECHNICAL INFORMATION	8
TEKNİK BİLGİLER	9
CERTIFICATE/SERTİFİKA	10
COLORS/RENKLER	11

TECHNICAL INFORMATION

01 PRODUCTION FINISHES STAGES

Demonstration of our finishing stages



-  Certified ZAMAK TYPE V (Raw Material)
-  1st Electroplated Copper Layer
-  2nd Electroplated Copper Layer
-  Very High Electroplated Nickel Leveling Layer
-  Laquer



Raw materials thickness:

ELECTROPLATING

Copper	4 µ
Nickel	10 µ
Chrome	0.1 up to 0.4 µ

Mesured in Micron (µ)

Electroforetik Lak

Varnish 9 up to 15 µ

7 years ÇEBİ warranties



2 years ÇEBİ warranties







02 ITEMS CODIFICATION DOOR LEVER HANDLES

- **Material**
 - A - Zamak
 - B - Aluminium
 - C - Abs or Polymer

- **Product Code** First bold numbers

- **Finish**
 - 1. MP - Plated Colors
 - 2. PC - Painted Colors

03 ICONS DEFINITION

-  Price by set
-  Price by piece
-  Packaging/inner box
-  Wood thickness

04 FIXING SCREWS

Included in price

TEKNİK BİLGİLER

01 ÜRETİM BİTİRME AŞAMALARI

Bitirme aşamalarının gösterimi



- Sertifikalı ZAMAK TİP V (Ham Malzeme)
- 1. Elektroliz Bakır Katman
- 2. Elektrolizle Kaplanmış Bakır Katman
- Çok Yüksek Elektroliz Nikel Tesviye Katmanı
- Lak



Hammadde Kalınlığı

GALVANİK KAPLAMA

Bakır	4 µ
Nikel	10 µ
Krom	0,1 ile 0,4 µ

Micron cinsinde ölçülür (µ)

Electroforetik Lak

Vernik	9 ile 15 µ
--------	------------

7 yıl ÇEBİ garantisi



2 yıl ÇEBİ garantisi

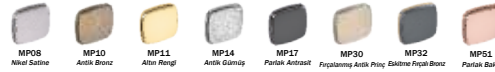

02 ÖĞELER, KODLANDIRMA, MOBİLYA KULPLARI

- Materyal
 - A - Zamak
 - B - Alüminyum
 - C - Abs veya Polimer

- Ürün Kodu İlk sayılar seri kodudur.

- Son
 - 1. Mp - Kaplama renkler
 - 2. Pc - Boyalı renkler

03 SİMGELERİN AÇIKLAMALARI

- (S) Sete göre fiyat
- (P) Parça başına fiyat
- 1 Ambalaj/iç kutu
- ||| Kapı kalınlığı
- Mil boyutu ve uzunluğu

04 SABİTLEME VİDALARI

Fiyata dahil

CERTIFICATE SERTİFİKA

Hane (Sıra) Position	1	2	3	4	5	6	7	8
Tanım Description	Kullanım kategorisi Category of use	Dayanıklılık sınıfı Durability class	Kapı kütlesi sınıfı Door mass class	Yangın dayanım sınıfı Fire resistance class	Emniyet sınıfı Safety class	Korozyon dayanım sınıfı Corrosion resistance class	Güvenlik sınıfı Security class	Çalışma şekli sınıfı Type of Operation
NUMARALANDIRMA DIGIT	3	7	-	0	0	3	0	Tıp B Type B
Sınıflandırma (min-max değerler) classification (min-max values)	1 - 4	6 - 7	-	0 - A - A1 B - B1 C - C1 D - D1	0 - 1	0 - 5	0 - 4	A - B - U
Sonuçların açıklanması Description of results	Yanlış kullanma ihtimali fazla olan insanların yüksek sıklıkta kullanımı için people who are more likely to misuse for frequent use	Yüksek sıklıkta kullanım: 200000 deney çevrimi High frequency use: 200000 test cycles.	Kalite sınıfı tanımlanmamıştır. The quality class is not defined.	Yangın/duman dayanım şartı yoktur. No fire/smoke resistance requirement B Sonrası: dumana ve yangına dayanıklı kapılar sonrası için uygundur. Post B: suitable for smoke and fire resistant doors	Normal kullanım Normal use	Yüksek korozyon direnci olan yüksek korozyon direnci Sınıf 3 : 120 saat korozyon direnci Class 3 : 120 hours corrosion resistance	Hırsızlığa karşı güvenlik şartı yoktur. No security requirement against theft	Yay yükü donanımına sahip kapı kolu Spring loaded door handles



**COLORS
RENKLER**

Kaplama Plating	Layer Layer	Minimum Kalınlık(mikron) Minimum Thickness(micron)
Galvanic Kaplama Electroplating	Bakır Copper	4 µ
Galvanic Kaplama Electroplating	Nikel Nickel	10 µ
Galvanic Kaplama Electroplating	Krom Chrome	0,1 up to 0,4 µ
Electroforetik Lak Electrophoretic Lacquer	Vernik Varnish	9 up to 15 µ

PAINTING COLORS/BOYAMA RENKLERİ



PLATING COLORS/KAPLAMA RENKLERİ

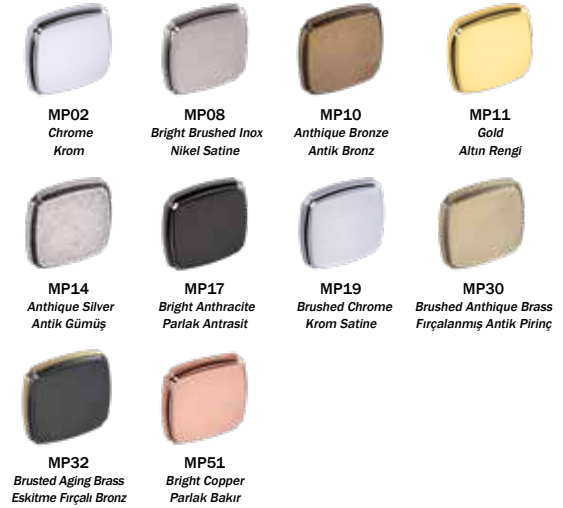

ÇEBİ COLOUR GROUP/ ÇEBİ RENK GRUPLARI

Group/Grup A	Group/Grup B	Group/Grup C	Group/Grup D
<p>PC04 Matt Nickel Mat Nikel Boya</p> <p>PC05 Mat Chrome Mat Krom Boya</p> <p>PC13 Rose Rose</p> <p>PC24 Matt Black Mat Siyah Boya</p> <p>PC27 Matt Anthracite Mat Antrasit Boya</p> <p>PC29 Metallic Bronze Metalik Bronz</p> <p>PC35 Brushed Brass Mat Sarı Boya</p> <p>PC36 Metallic Brown Metalik Kahve</p>	<p>MP02 Chrome Krom</p> <p>MP10 Antique Bronze Antik Bronz</p>	<p>MP08 Bright Brushed Inox Nikel Satine</p> <p>MP11 Gold Altın Rengi</p> <p>MP17 Bright Anthracite Parlak Antrasit</p> <p>MP19 Brushed Chrome Krom Satine</p>	<p>MP14 Antique Silver Antik Gümüş</p> <p>MP30 Brushed Antique Brass Fırçalanmış Antik Pirinç</p> <p>MP32 Brused Aging Brass Eskitme Fırçalı Bronz</p> <p>MP51 Bright Copper Parlak Bakır</p>

**2 YEAR WARRANTIES
2 YIL GARANTİ**



**7 YEAR WARRANTIES
7 YIL GARANTİ**





MODERN FURNITURE
HANDLES & KNOBS
MODERN MOBİLYA
KULPLARI VE DÜĞMELERİ

Discover new passions

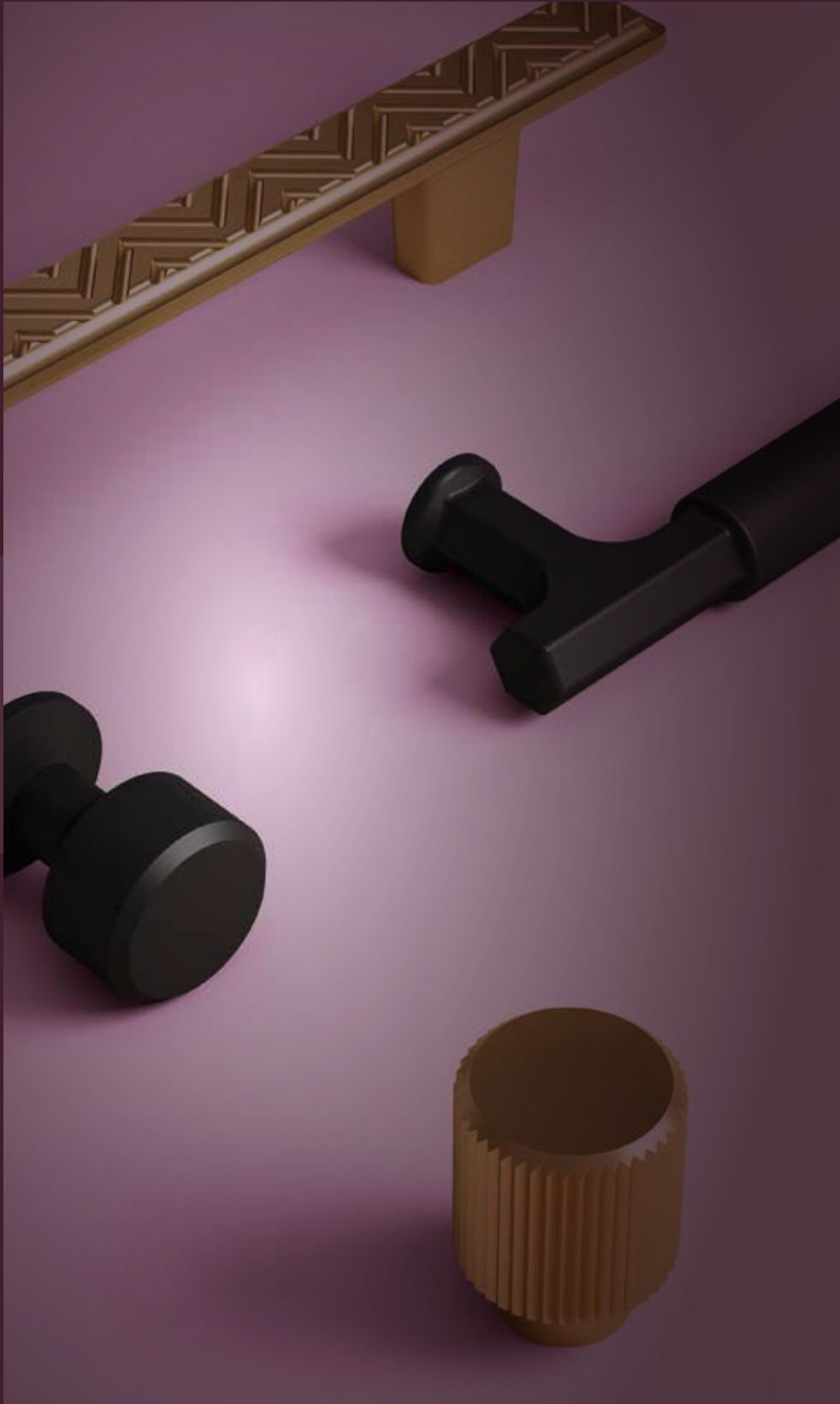

A 126730704

288

128

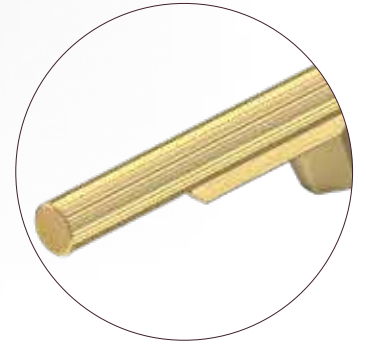
Material
Zinc Alloy
AlMaterial
Zağnak
&
Alüminyum

Kod	Uzunluk	Merkez	Genişlik	Yükseklik
Code	Length	Central	Width	Height
A126730704	916 mm	704 mm	16 mm	38 mm
A126730288	500 mm	288 mm	16 mm	38 mm
A126730128	340 mm	128 mm	16 mm	38 mm

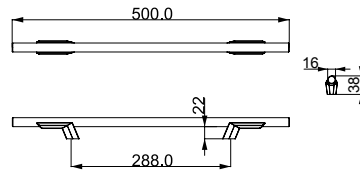

A126730288

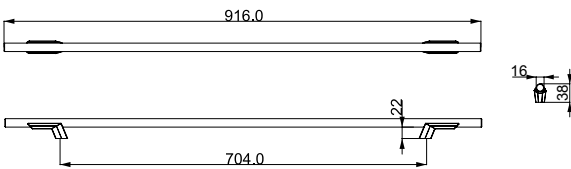

A126730704

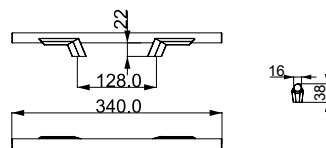

A126730128

STANDARD FINISHES
STANDART RENKLER

A 126720704

288

128

Material
Zinc Alloy
ALMaterial
Zağnak
&
Alüminyum

Kod	Uzunluk	Merkez	Genişlik	Yükseklik
Code	Length	Central	Width	Height
A126720704	916 mm	704 mm	16 mm	38 mm
A126720288	500 mm	288 mm	16 mm	38 mm
A126720128	340 mm	128 mm	16 mm	38 mm

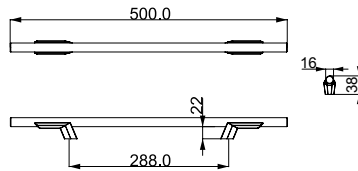
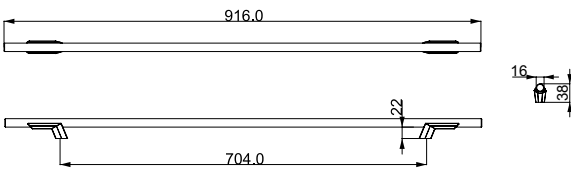
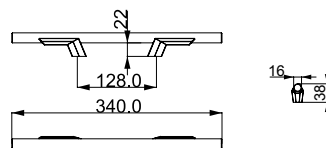
**A126720288****A126720704****A126720128****STANDARD FINISHES**
STANDART RENKLER

A 126710704

288

128

Material
Zinc Alloy
AlMaterial
Zağnak
&
Alüminyum

Kod	Uzunluk	Merkez	Genişlik	Yükseklik
Code	Length	Central	Width	Height
A126710704	916 mm	704 mm	16 mm	38 mm
A126710288	500 mm	288 mm	16 mm	38 mm
A126710128	340 mm	128 mm	16 mm	38 mm

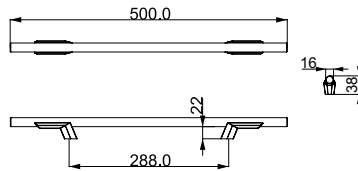

A126710288

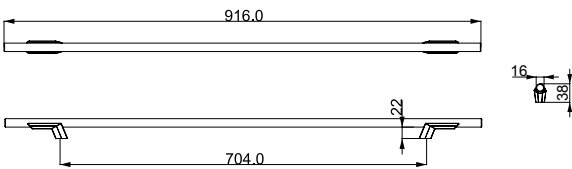

A126710704

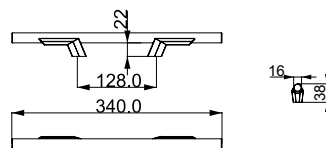

A126710128

STANDARD FINISHES
STANDART RENKLER

A 126330704

288

128

A 424230016

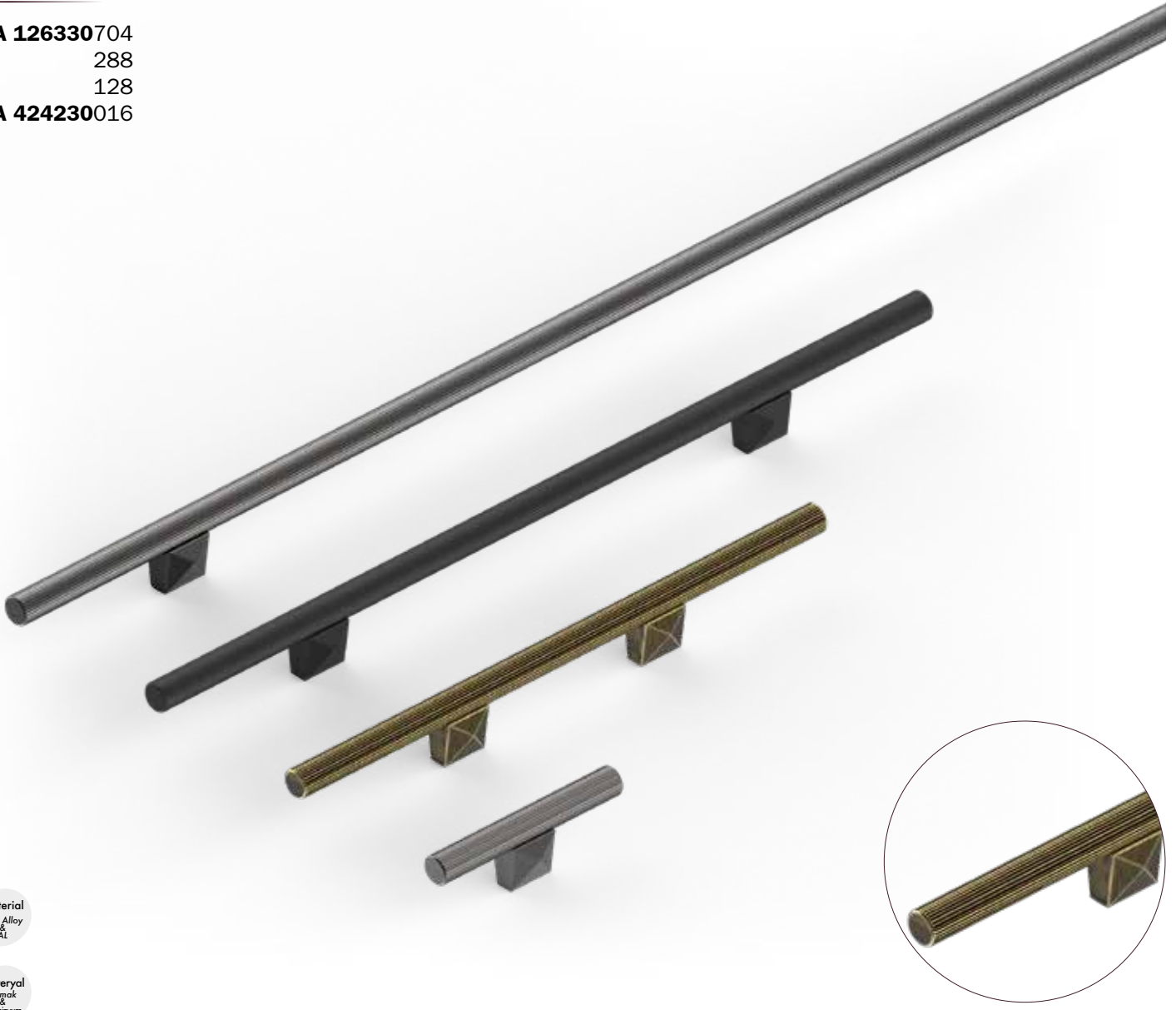
Material
Zinc Alloy
ALMaterial
Zağnak
&
Alüminyum

Kod	Uzunluk	Merkez	Genişlik	Yükseklik
Code	Length	Central	Width	Height
A126330704	916 mm	704 mm	16 mm	38 mm
A126330288	500 mm	288 mm	16 mm	38 mm
A126330128	340 mm	128 mm	16 mm	38 mm
A424230016	116 mm	16 mm	16 mm	38 mm

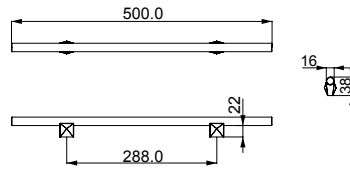

A126330288

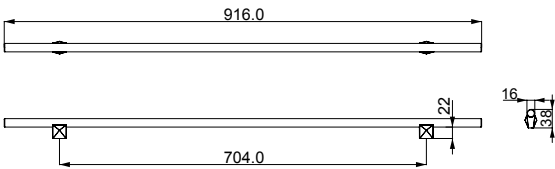

A126330704

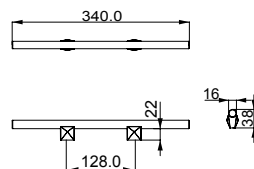

A126330128

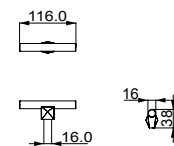

A424230016

STANDARD FINISHES
STANDART RENKLER

A 126320704

288

128

A 424220016

Material
Zinc Alloy
ALMaterial
Zağnak
&
Alüminyum

Kod	Uzunluk	Merkez	Genişlik	Yükseklik
Code	Length	Central	Width	Height
A126320704	916 mm	704 mm	16 mm	38 mm
A126320288	500 mm	288 mm	16 mm	38 mm
A126320128	340 mm	128 mm	16 mm	38 mm
A424220016	116 mm	16 mm	16 mm	38 mm

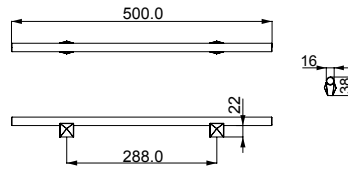

A126320288

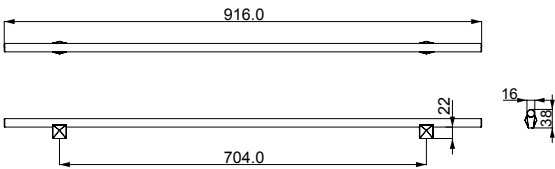

A126320704

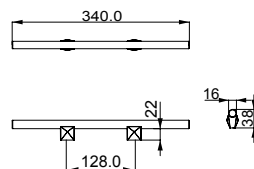

A126320128

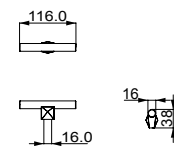

A424220016

STANDARD FINISHES
STANDART RENKLER

A 126310704

288

128

A 424210016Material
Zinc Alloy
ALMaterial
Zağnak
&
Alüminyum

Kod	Uzunluk	Merkez	Genişlik	Yükseklik
Code	Length	Central	Width	Height
A126310704	916 mm	704 mm	16 mm	38 mm
A126310288	500 mm	288 mm	16 mm	38 mm
A126310128	340 mm	128 mm	16 mm	38 mm
A424210016	116 mm	16 mm	16 mm	38 mm

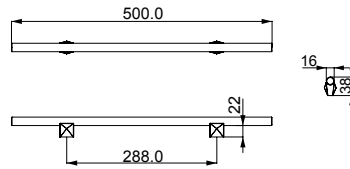
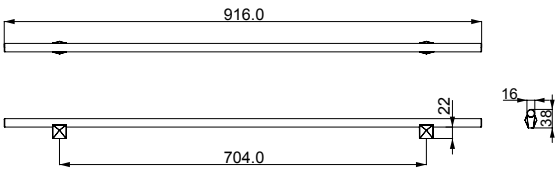
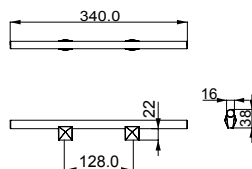
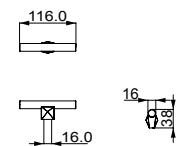
**A126310288****A126310704****A126310128****A424210016****STANDARD FINISHES**
STANDART RENKLER

A 126030800

384

224

A 424130016



Material
Zinc Alloy
AL

Material
Zağnak
&
Alüminyum

Kod	Uzunluk	Merkez	Genişlik	Yükseklik
Code	Length	Central	Width	Height
A126030800	916 mm	800 mm	16 mm	40 mm
A126030384	500 mm	384 mm	16 mm	40 mm
A126030224	340 mm	224 mm	16 mm	40 mm
A424130016	116 mm	16 mm	16 mm	40 mm

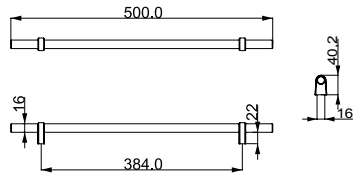

A126030384

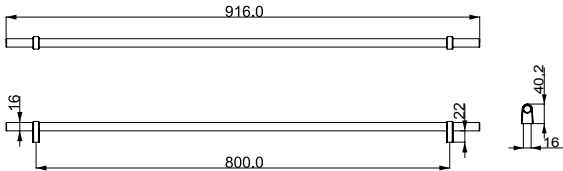

A126030800

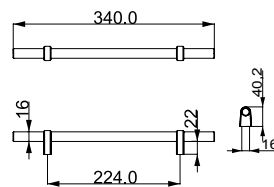

A126030224

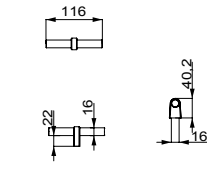

A424130016

STANDARD FINISHES
STANDART RENKLER



A 126020800

384

224

A 424120016Material
Zinc Alloy
ALMaterial
Zağnak
&
Alüminyum

Kod	Uzunluk	Merkez	Genişlik	Yükseklik
Code	Length	Central	Width	Height
A126020800	916 mm	800 mm	16 mm	40 mm
A126020384	500 mm	384 mm	16 mm	40 mm
A126020224	340 mm	224 mm	16 mm	40 mm
A424120016	116 mm	16 mm	16 mm	40 mm

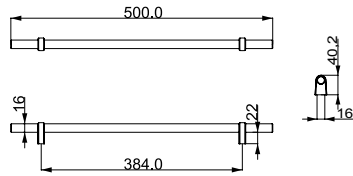
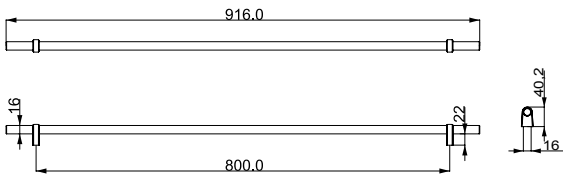
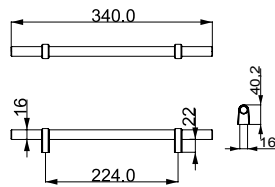
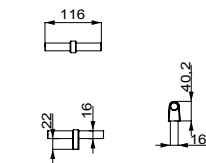
**A126020384****A126020800****A126020224****A424120016****STANDARD FINISHES**
STANDART RENKLER

A 126010800

384

224

A 424110016Material
Zinc Alloy
ALMaterial
Zağnak
&
Alüminyum

Kod	Uzunluk	Merkez	Genişlik	Yükseklik
Code	Length	Central	Width	Height
A126010800	916 mm	800 mm	16 mm	40 mm
A126010384	500 mm	384 mm	16 mm	40 mm
A126010224	340 mm	224 mm	16 mm	40 mm
A424110016	116 mm	16 mm	16 mm	40 mm

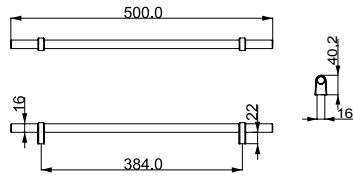
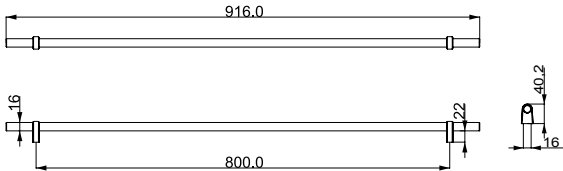
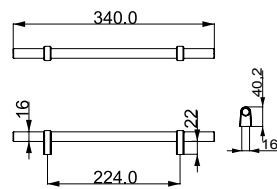
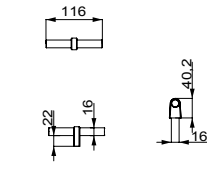
**A126010384****A126010800****A126010224****A424110016****STANDARD FINISHES**
STANDART RENKLER

A 124330896

480

320

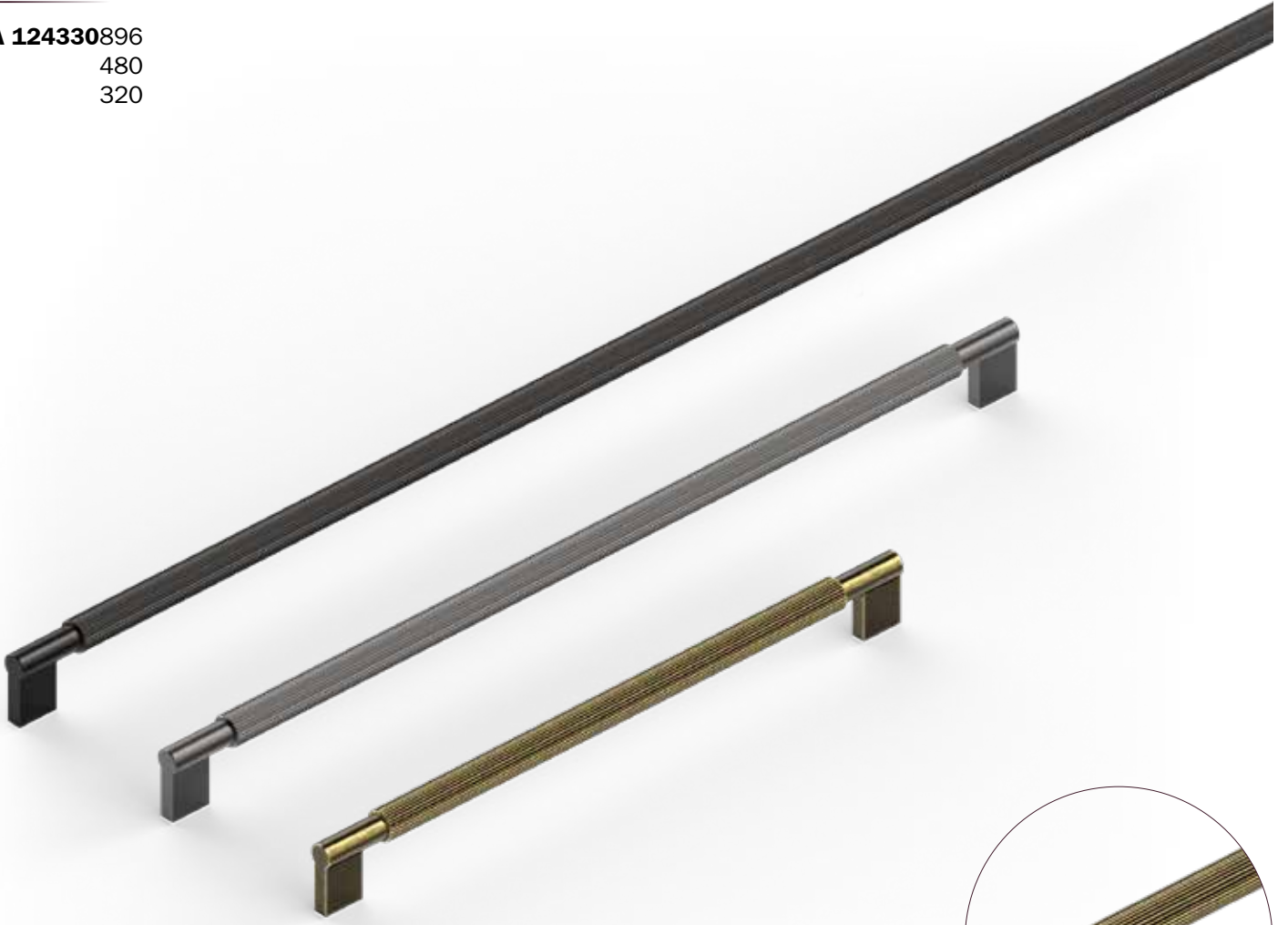
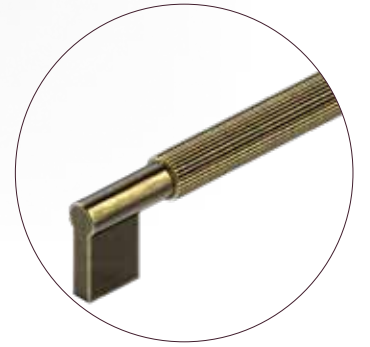
Material
Zinc Alloy
&
AlMaterial
Zağnak
&
Alüminyum

Kod	Uzunluk	Merkez	Genişlik	Yükseklik
Code	Length	Central	Width	Height
A124330896	918 mm	896 mm	16 mm	38 mm
A124330480	502 mm	480 mm	16 mm	38 mm
A124330320	342 mm	320 mm	16 mm	38 mm

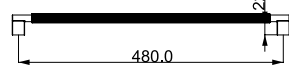
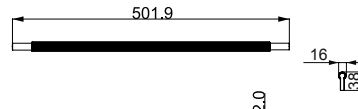
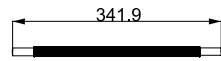
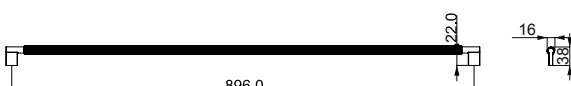
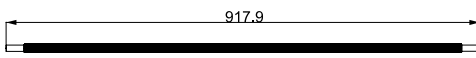
**A124330480****A124330320****A124330896****STANDARD FINISHES**
STANDART RENKLER

A 124320896

480

320

Material
Zinc Alloy
AlMaterial
Zağnak
&
Alüminyum

Kod	Uzunluk	Merkez	Genişlik	Yükseklik
Code	Length	Central	Width	Height
A124320896	918 mm	896 mm	16 mm	38 mm
A124320480	502 mm	480 mm	16 mm	38 mm
A124320320	342 mm	320 mm	16 mm	38 mm

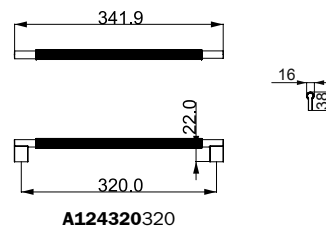
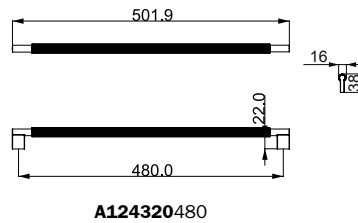
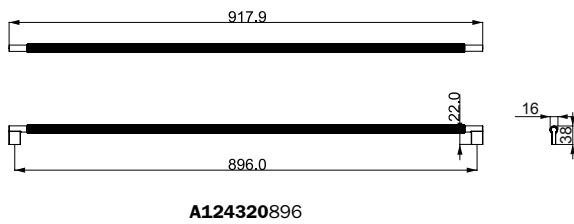
STANDARD FINISHES
STANDART RENKLER

A 124310896

480

320



Material
Zinc Alloy
&
Al

Material
Zağnak
&
Alüminyum

Kod	Uzunluk	Merkez	Genişlik	Yükseklik
Code	Length	Central	Width	Height
A124310896	918 mm	896 mm	16 mm	38 mm
A124310480	502 mm	480 mm	16 mm	38 mm
A124310320	342 mm	320 mm	16 mm	38 mm

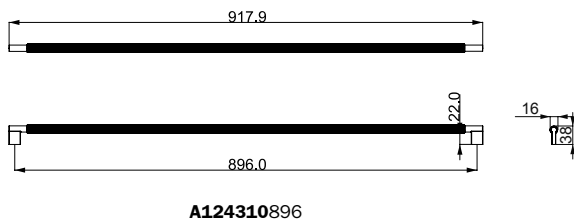

A124310896

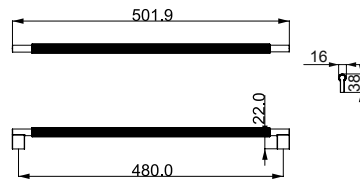

A124310480

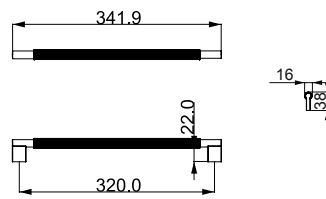

A124310320

STANDARD FINISHES
STANDART RENKLER



A 124030896

480

320

A 424030016

Material
Zinc Alloy
AlMaterial
Zağnak
&
Alüminyum

Kod	Uzunluk	Merkez	Genişlik	Yükseklik
Code	Length	Central	Width	Height
A124030896	916 mm	896 mm	16 mm	38 mm
A124030480	500 mm	480 mm	16 mm	38 mm
A124030320	340 mm	320 mm	16 mm	38 mm
A424030016	116 mm	16 mm	16 mm	38 mm

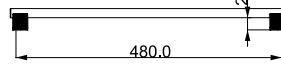
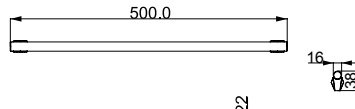

A124030480

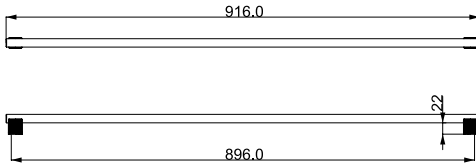

A124030896

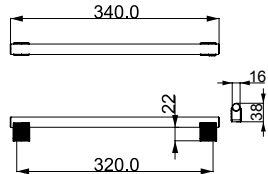

A124030320

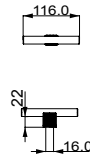

A424030016

STANDARD FINISHES
STANDART RENKLER

A 124020896

480

320

A 424020016



Material
Zinc Alloy
AL

Material
Zağnak
&
Alüminyum

Kod	Uzunluk	Merkez	Genişlik	Yükseklik
Code	Length	Central	Width	Height
A124020896	916 mm	896 mm	16 mm	38 mm
A124020480	500 mm	480 mm	16 mm	38 mm
A124020320	340 mm	320 mm	16 mm	38 mm
A424020016	116 mm	16 mm	16 mm	38 mm

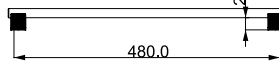
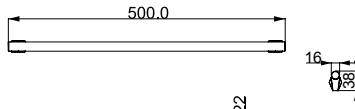

A124020480

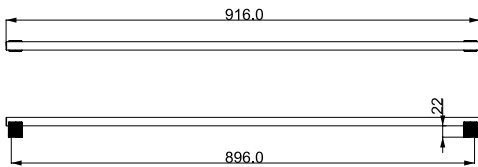

A124020896

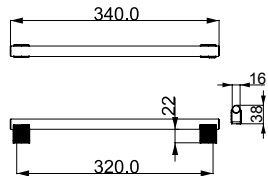

A124020320

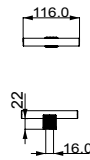

A424020016

STANDARD FINISHES
STANDART RENKLER



A 124010896

480

320

A 424010016

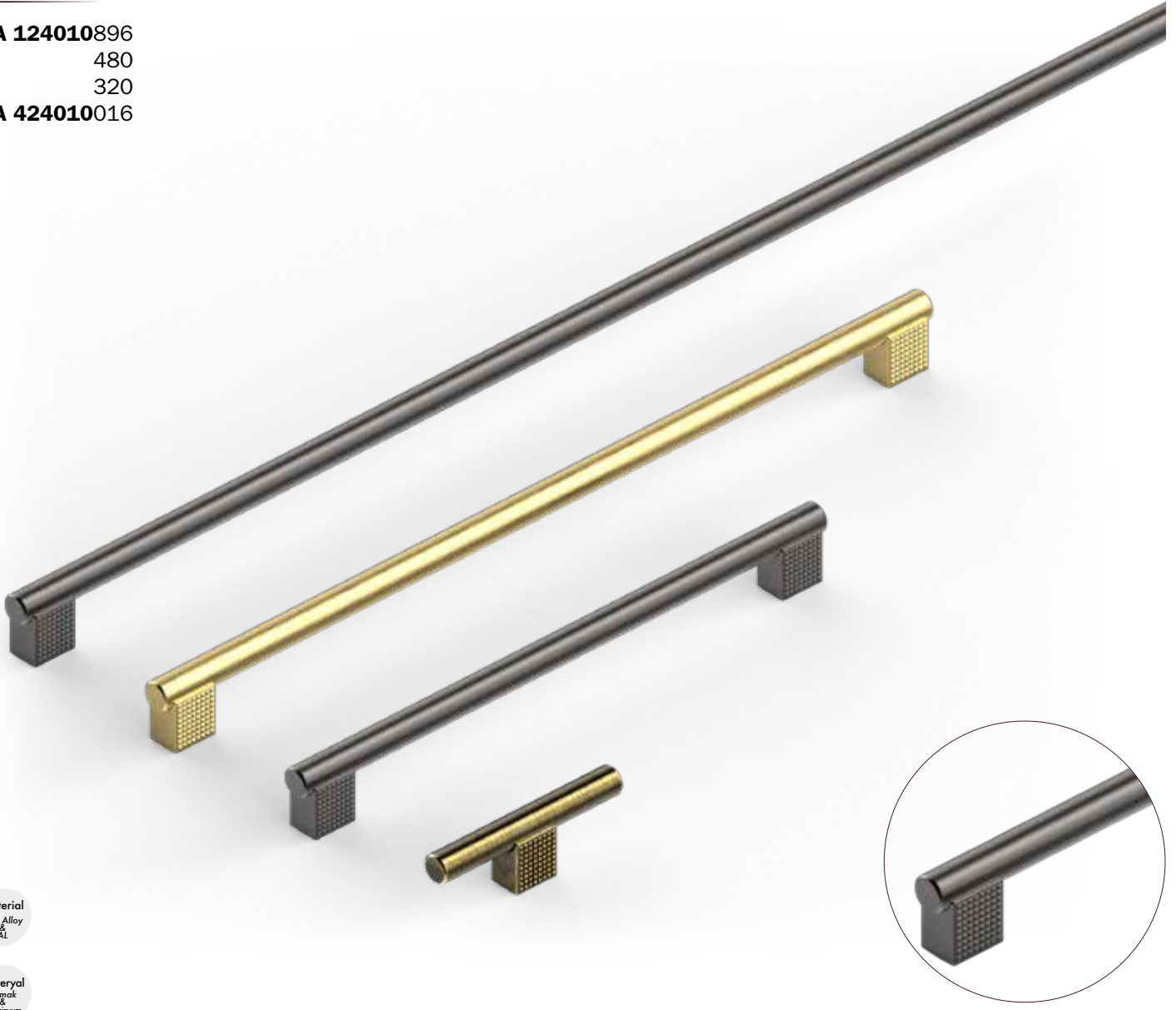
Material
Zinc Alloy
ALMaterial
Zeytin
&
Alüminyum

Kod	Uzunluk	Merkez	Genişlik	Yükseklik
Code	Length	Central	Width	Height
A124010896	916 mm	896 mm	16 mm	38 mm
A124010480	500 mm	480 mm	16 mm	38 mm
A124010320	340 mm	320 mm	16 mm	38 mm
A424010016	116 mm	16 mm	16 mm	38 mm

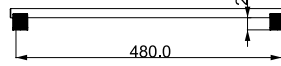
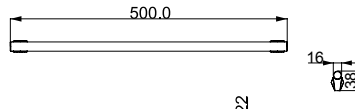

A124010480

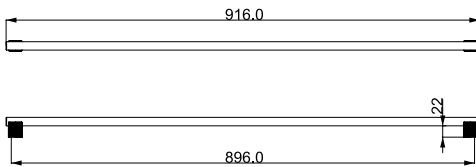

A124010896

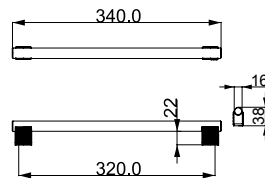

A124010320

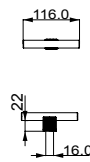

A424010016

STANDARD FINISHES
STANDART RENKLER

A 123930896

480

320

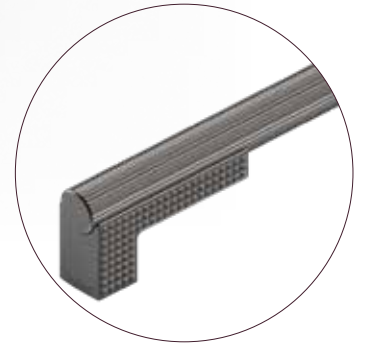
Material
Zinc Alloy
AlMaterial
Zincak
&
Alüminyum

Kod	Uzunluk	Merkez	Genişlik	Yükseklik
Code	Length	Central	Width	Height
A123930896	916 mm	896 mm	16 mm	38 mm
A123930480	500 mm	480 mm	16 mm	38 mm
A123930320	340 mm	320 mm	16 mm	38 mm

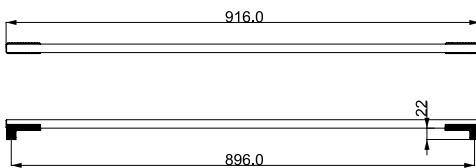
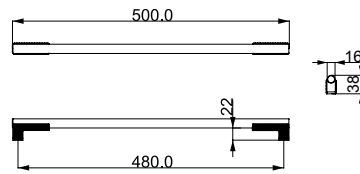
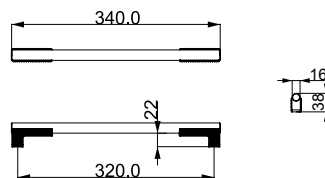
**A123930896****A123930480****A123930320****STANDARD FINISHES**
STANDART RENKLER**MP30**
Brushed Antique Brass
Fırçalanmış Antik Pirinç**PC24**
Matt Black
Mat Siyah Boya**PC27**
Matt Anthracite
Mat Antrasit Boya**PC35**
Brushed Brass
Mat Sarı Boya

A 123920896

480

320

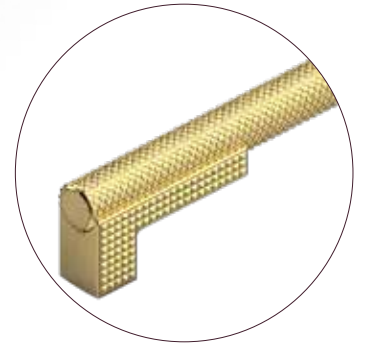
Material
Zinc Alloy
AlMaterial
Zağnak
&
Alüminyum

Kod	Uzunluk	Merkez	Genişlik	Yükseklik
Code	Length	Central	Width	Height
A123920896	916 mm	896 mm	16 mm	38 mm
A123920480	500 mm	480 mm	16 mm	38 mm
A123920320	340 mm	320 mm	16 mm	38 mm

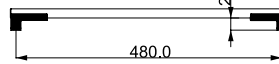
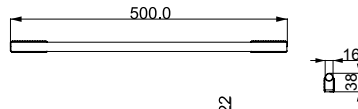

A123920480

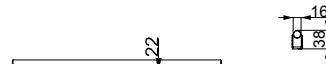
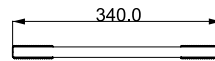

A123920320

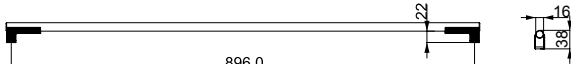
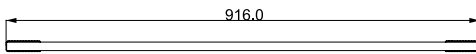

A123920896

STANDARD FINISHES
STANDART RENKLER

A 123910896

480

320

Material
Zinc Alloy
ALMaterial
Zağnak
&
Alüminyum

Kod	Uzunluk	Merkez	Genişlik	Yükseklik
Code	Length	Central	Width	Height
A123910896	916 mm	896 mm	16 mm	38 mm
A123910480	500 mm	480 mm	16 mm	38 mm
A123910320	340 mm	320 mm	16 mm	38 mm

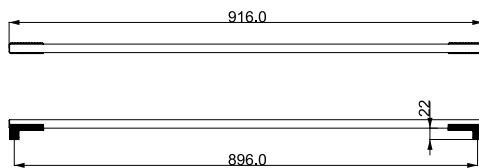
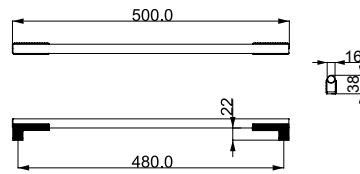
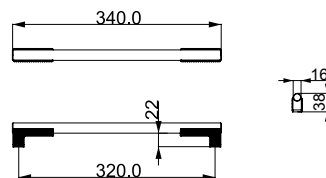
**A123910896****A123910480****A123910320****STANDARD FINISHES**
STANDART RENKLER**MP30**
Brushed Antique Brass
Fırçalanmış Antik Pirinç**PC24**
Matt Black
Mat Siyah Boya**PC27**
Matt Anthracite
Mat Antrasit Boya**PC35**
Brushed Brass
Mat Sarı Boya



MODERN FURNITURE
HANDLES & KNOBS
MODERN MOBİLYA
KULPLARI VE DÜĞMELERİ

Discover new passions

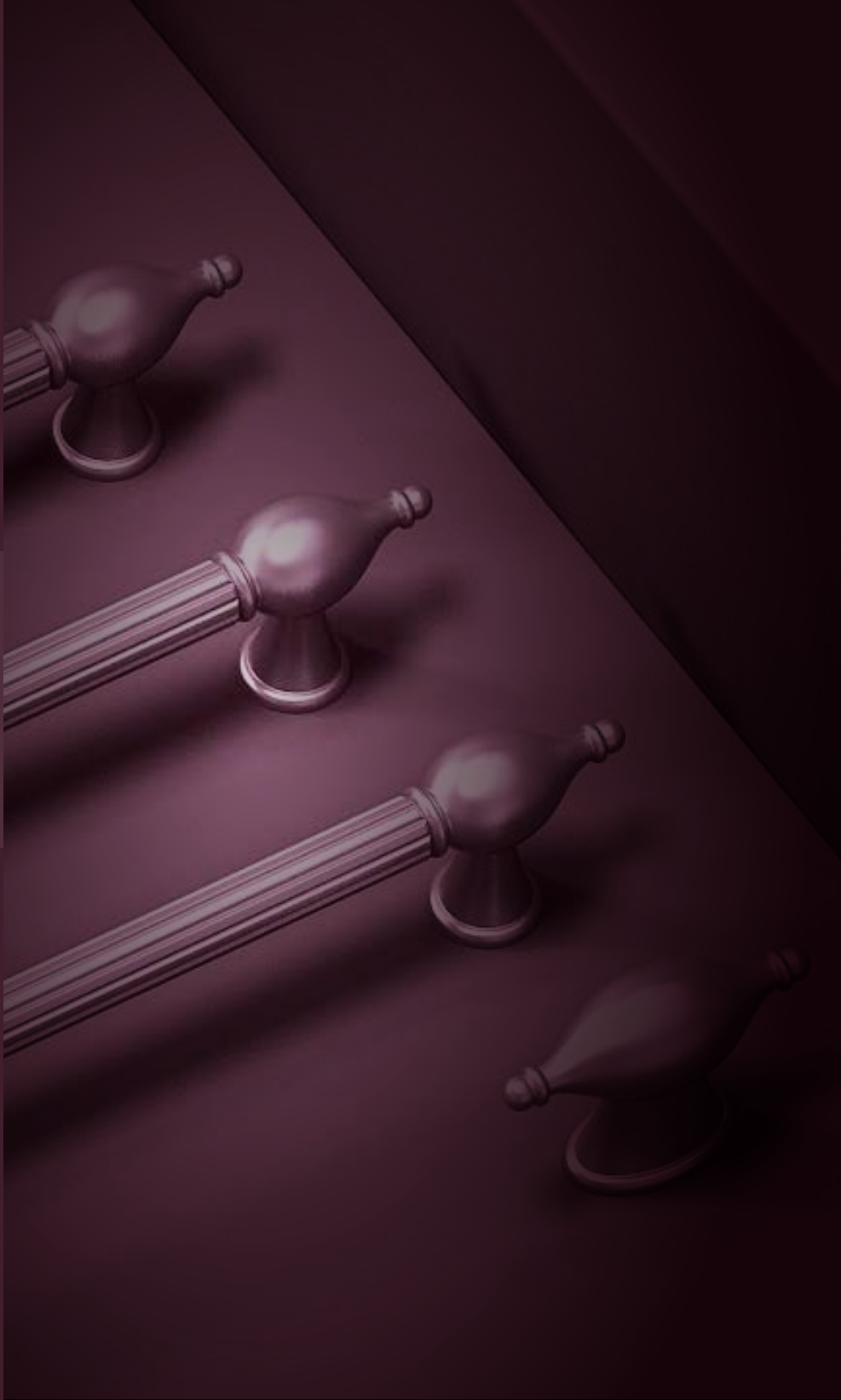

A 1283128
064Material
Zinc AlloyMateryal
Zamak

Kod	Uzunluk	Merkez	Genişlik	Yükseklik
Code	Length	Central	Width	Height
A1283128	147 mm	128 mm	53 mm	19 mm
A1283064	79 mm	64 mm	79 mm	19 mm

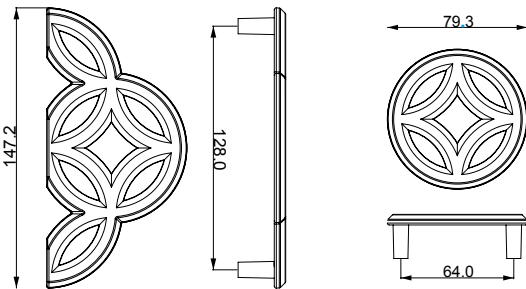
STANDARD FINISHES
STANDART RENKLERMP02
Chrome
KromPC24
Matt Black
Mat Siyah BoyaMP11
Gold
Altın RengiPC27
Matt Anthracite
Mat Antrasit BoyaMP30
Brushed Antique Brass
Firçalanmış Antik PirinçPC35
Brushed Brass
Mat Sarı Boya

A 1282096
064

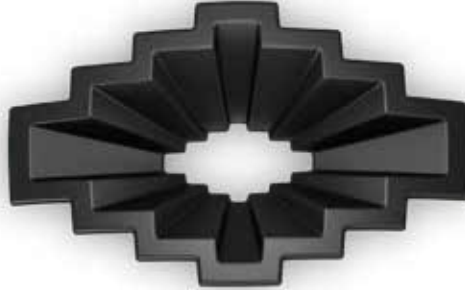
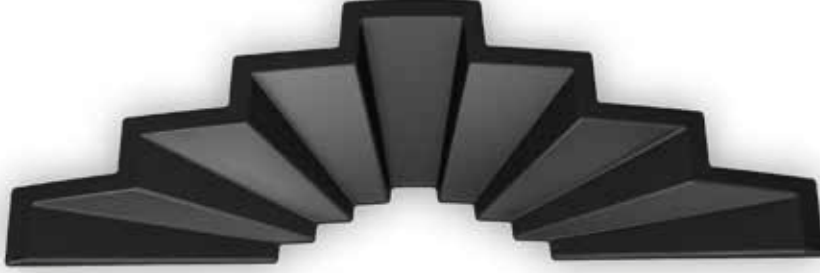

Material
Zinc Alloy

Materyal
Zamak

Kod	Uzunluk	Merkez	Genişlik	Yükseklik
Code	Length	Central	Width	Height
A1282096	178 mm	96 mm	53 mm	28 mm
A1282064	105 mm	64 mm	63 mm	27 mm

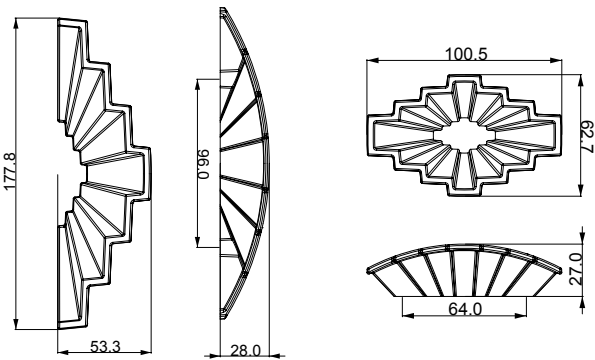

STANDARD FINISHES
STANDART RENKLER



PC24
Matt Black
Mat Siyah Boya



PC27
Matt Anthracite
Mat Antrasit Boya



PC35
Brushed Brass
Mat Sarı Boya

A 1281320

160

A 4281016

Material
Zinc AlloyMaterial
Zamak

Kod	Uzunluk	Merkez	Genişlik	Yükseklik
Code	Length	Central	Width	Height
A1281320	347 mm	320 mm	9 mm	33 mm
A1281160	187 mm	160 mm	9 mm	33 mm
A4281016	34 mm	16 mm	34 mm	28 mm

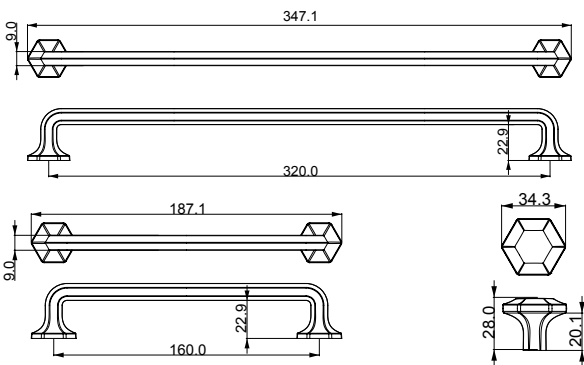
STANDARD FINISHES
STANDART RENKLERMP02
Chrome
KromPC24
Matt Black
Mat Siyah BoyaMP11
Gold
Altın RengiPC27
Matt Anthracite
Mat Antrasit BoyaMP30
Brushed Antique Brass
Firçalanmış Antik PirinçPC35
Brushed Brass
Mat Sarı Boya

A 1280320

160

A 4280016

Material
Zinc AlloyMateryal
Zamak

Kod	Uzunluk	Merkez	Genişlik	Yükseklik
Code	Length	Central	Width	Height
A1280320	340 mm	320 mm	22 mm	32 mm
A1280160	180 mm	160 mm	22 mm	32 mm
A4280016	35 mm	16 mm	35 mm	33 mm

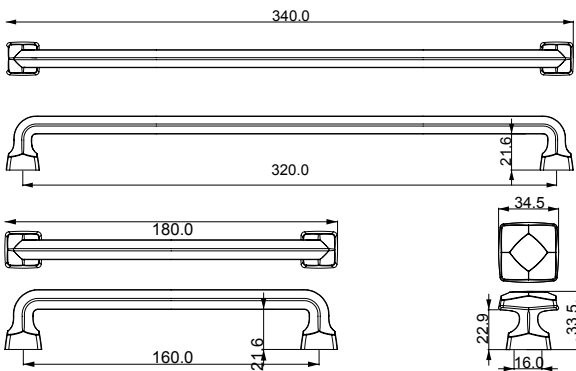
STANDARD FINISHES
STANDART RENKLERMP02
Chrome
KromPC24
Matt Black
Mat Siyah BoyaMP11
Gold
Altın RengiPC27
Matt Anthracite
Mat Antrasit BoyaMP30
Brushed Antique Brass
Fırçalanmış Antik PirinçPC35
Brushed Brass
Mat Sarı Boya

A 1279320

160

A 4279016

Material
Zinc AlloyMaterial
Zamak

Kod	Uzunluk	Merkez	Genişlik	Yükseklik
Code	Length	Central	Width	Height
A1279320	380 mm	320 mm	24 mm	39 mm
A1279160	220 mm	160 mm	24 mm	39 mm
A4279016	60 mm	16 mm	24 mm	39 mm

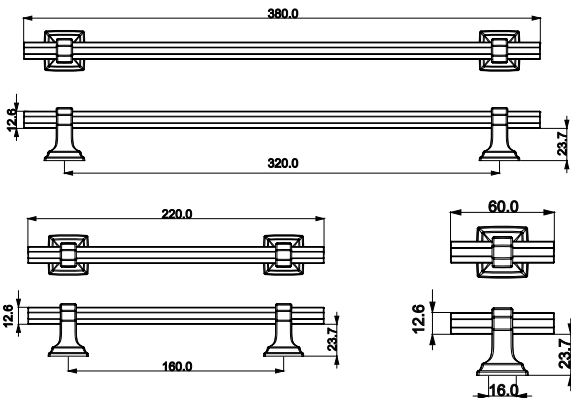
STANDARD FINISHES
STANDART RENKLERMP02
Chrome
KromPC24
Matt Black
Mat Siyah BoyaMP11
Gold
Altın RengiPC27
Matt Anthracite
Mat Antrasit BoyaMP30
Brushed Antique Brass
Fırçalanmış Antik PirinçPC35
Brushed Brass
Mat Sarı Boya

A 1278320

160

A 4278016

Material
Zinc AlloyMateryal
Zamak

Kod	Uzunluk	Merkez	Genişlik	Yükseklik
Code	Length	Central	Width	Height
A1278320	392 mm	320 mm	28 mm	29 mm
A1278160	232 mm	160 mm	28 mm	29 mm
A4278016	72 mm	16 mm	28 mm	29 mm

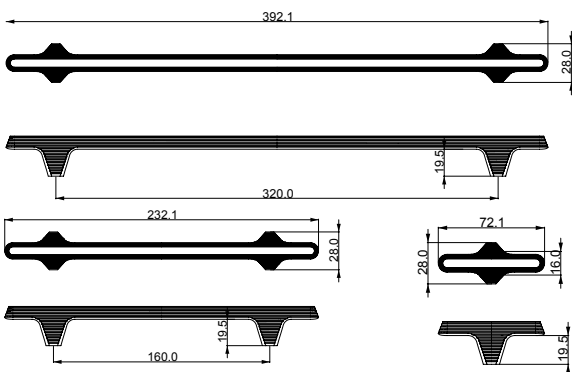
STANDARD FINISHES
STANDART RENKLERMP02
Chrome
KromPC24
Matt Black
Mat Siyah BoyaMP11
Gold
Altın RengiPC27
Matt Anthracite
Mat Antrasit BoyaMP30
Brushed Antique Brass
Firçalanmış Antik PırnçPC35
Brushed Brass
Mat Sarı Boya

A 1275320

160

A 4275016

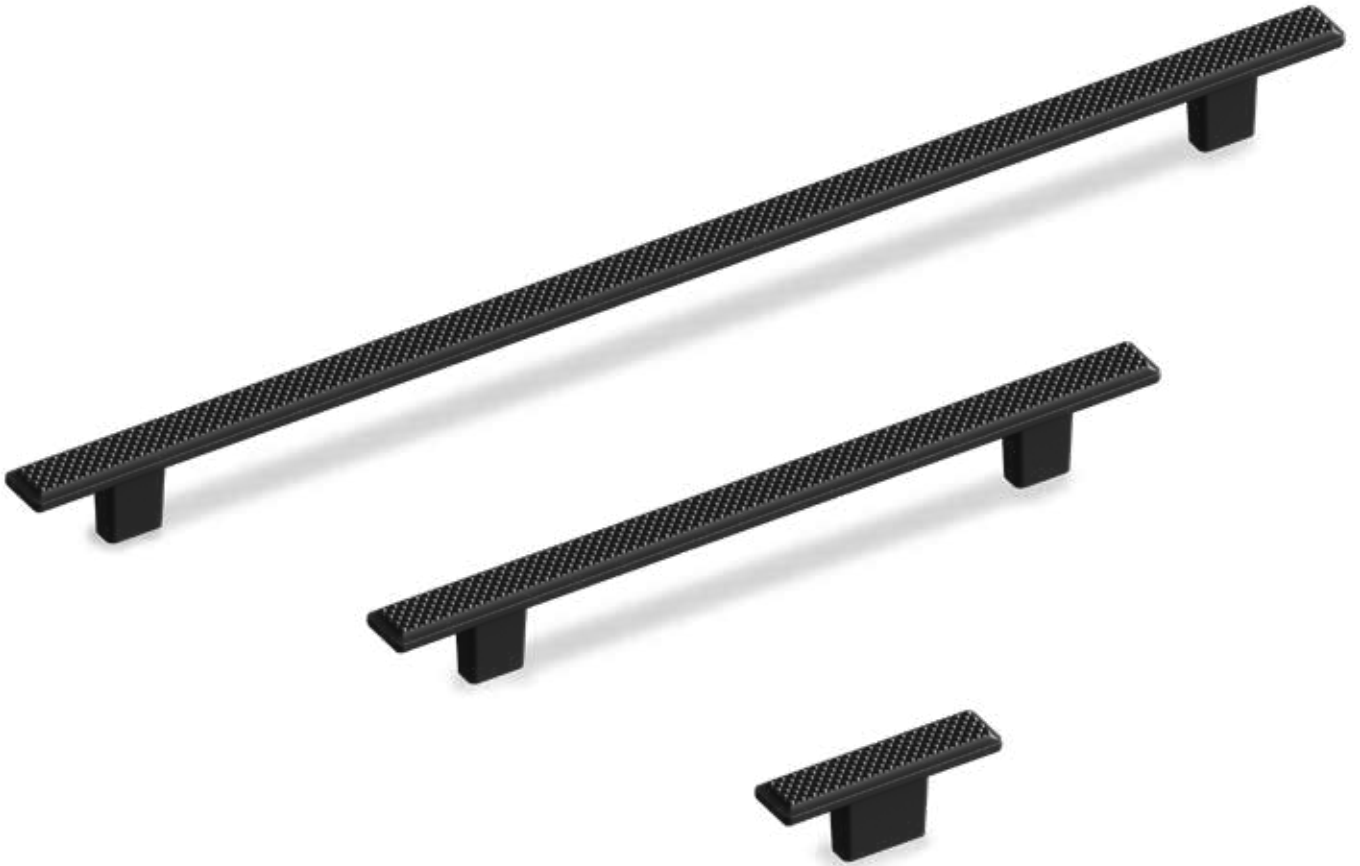
Material
Zinc AlloyMateryal
Zamak

Kod	Uzunluk	Merkez	Genişlik	Yükseklik
Code	Length	Central	Width	Height
A1275320	384 mm	320 mm	16 mm	26 mm
A1275160	224 mm	160 mm	16 mm	26 mm
A4275016	64 mm	16 mm	16 mm	26 mm

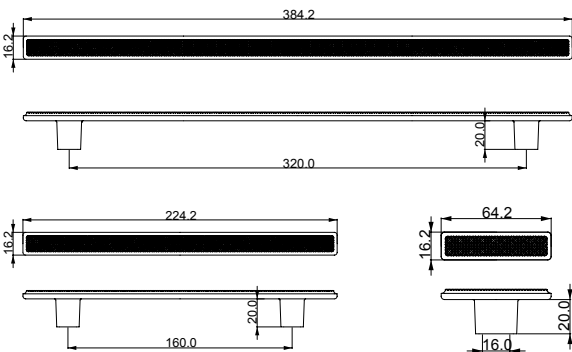
STANDARD FINISHES
STANDART RENKLERMP02
Chrome
KromPC24
Matt Black
Mat Siyah BoyaMP11
Gold
Altın RengiPC27
Matt Anthracite
Mat Antrasit BoyaMP30
Brushed Antique Brass
Firçalanmış Antik PırnçPC35
Brushed Brass
Mat Sarı Boya

A 1274320

160

A 4274016Material
Zinc AlloyMateriyal
Zamak

Kod	Uzunluk	Merkez	Genişlik	Yükseklik
Code	Length	Central	Width	Height
A1274320	384 mm	320 mm	16 mm	26 mm
A1274160	224 mm	160 mm	16 mm	26 mm
A4274016	64 mm	16 mm	16 mm	26 mm

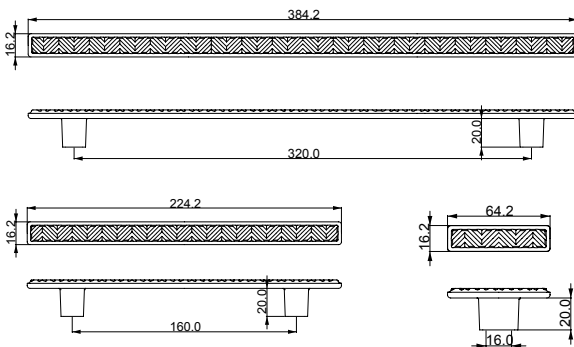
**STANDARD FINISHES**
STANDART RENKLER**MP02**
Chrome
Krom**PC24**
Matt Black
Mat Siyah Boya**MP11**
Gold
Altın Rengi**PC27**
Matt Anthracite
Mat Antrasit Boya**MP30**
Brushed Antique Brass
Firçalanmış Antik Pirinç**PC35**
Brushed Brass
Mat Sarı Boya

A 1273320

160

A 4273016

Material
Zinc AlloyMateryal
Zamak

Kod	Uzunluk	Merkez	Genişlik	Yükseklik
Code	Length	Central	Width	Height
A1273320	384 mm	320 mm	16 mm	26 mm
A1273160	224 mm	160 mm	16 mm	26 mm
A4273016	64 mm	16 mm	16 mm	26 mm

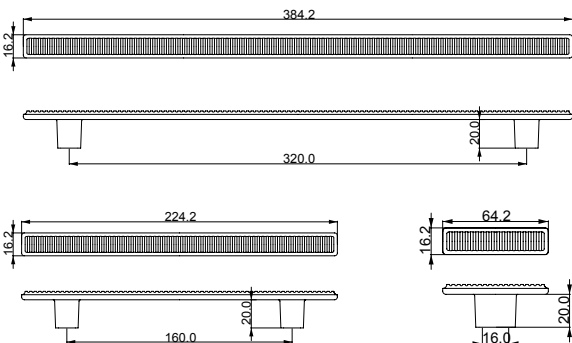
STANDARD FINISHES
STANDART RENKLERMP02
Chrome
KromPC24
Matt Black
Mat Siyah BoyaMP11
Gold
Altın RengiPC27
Matt Anthracite
Mat Antrasit BoyaMP30
Brushed Antique Brass
Firçalanmış Antik PırnçPC35
Brushed Brass
Mat Sarı Boya

A 1272320

160

A 4272016

Material
Zinc AlloyMateryal
Zamak

Kod	Uzunluk	Merkez	Genişlik	Yükseklik
Code	Length	Central	Width	Height
A1272320	384 mm	320 mm	16 mm	27 mm
A1272160	224 mm	160 mm	16 mm	27 mm
A4272016	64 mm	16 mm	16 mm	27 mm

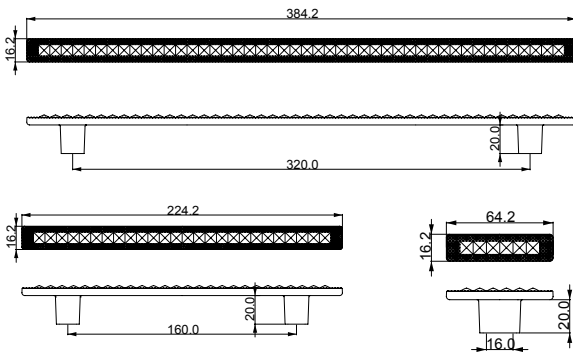
STANDARD FINISHES
STANDART RENKLERMP02
Chrome
KromPC24
Matt Black
Mat Siyah BoyaMP11
Gold
Altın RengiPC27
Matt Anthracite
Mat Antrasit BoyaMP30
Brushed Antique Brass
Fırçalanmış Antik PirinçPC35
Brushed Brass
Mat Sarı Boya

A 1271320

160

A 4271016

Material
Zinc AlloyMateriyal
Zamak

Kod	Uzunluk	Merkez	Genişlik	Yükseklik
Code	Length	Central	Width	Height
A1271320	384 mm	320 mm	16 mm	26 mm
A1271160	224 mm	160 mm	16 mm	26 mm
A4271016	64 mm	16 mm	16 mm	26 mm

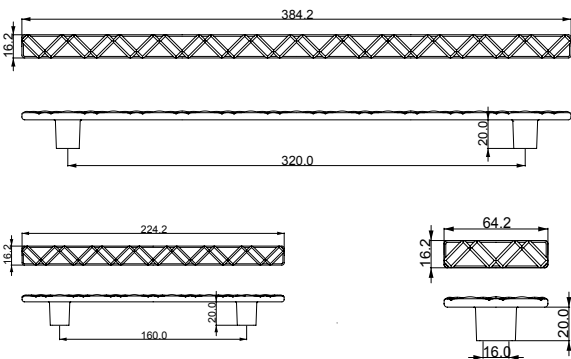
STANDARD FINISHES
STANDART RENKLERMP02
Chrome
KromPC24
Matt Black
Mat Siyah BoyaMP11
Gold
Altın RengiPC27
Matt Anthracite
Mat Antrasit BoyaMP30
Brushed Antique Brass
Fırçalanmış Antik PirinçPC35
Brushed Brass
Mat Sarı Boya

A 1270320
160
A 4270016

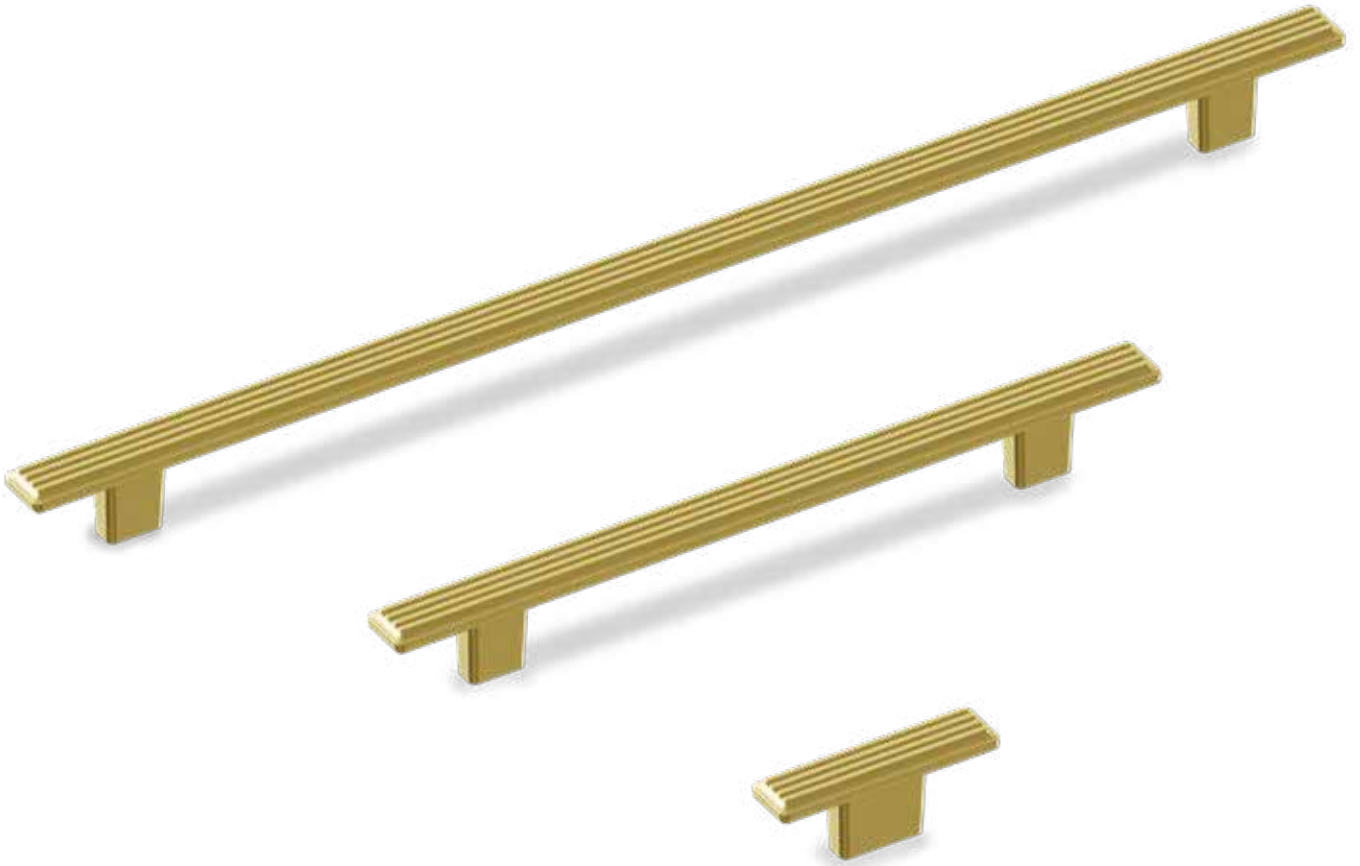

Material
Zinc Alloy

Materyal
Zamak

Kod	Uzunluk	Merkez	Genişlik	Yükseklik
Code	Length	Central	Width	Height
A1270320	384 mm	320 mm	16 mm	26 mm
A1270160	224 mm	160 mm	16 mm	26 mm
A4270016	64 mm	16 mm	16 mm	26 mm

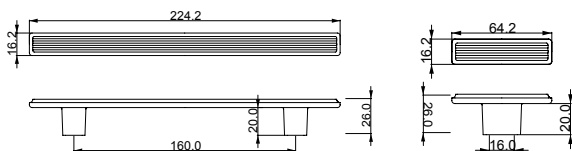
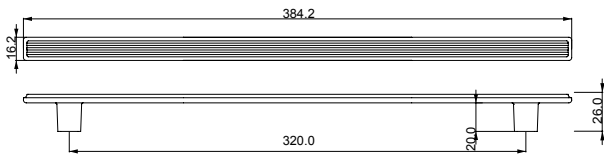

STANDARD FINISHES
STANDART RENKLER



MP02
Chrome
Krom



PC24
Matt Black
Mat Siyah Boya



MP11
Gold
Altın Rengi



PC27
Matt Anthracite
Mat Antrasit Boya



MP30
Brushed Antique Brass
Fırçalanmış Antik Pirinç



PC35
Brushed Brass
Mat Sarı Boya

A 1140192

096

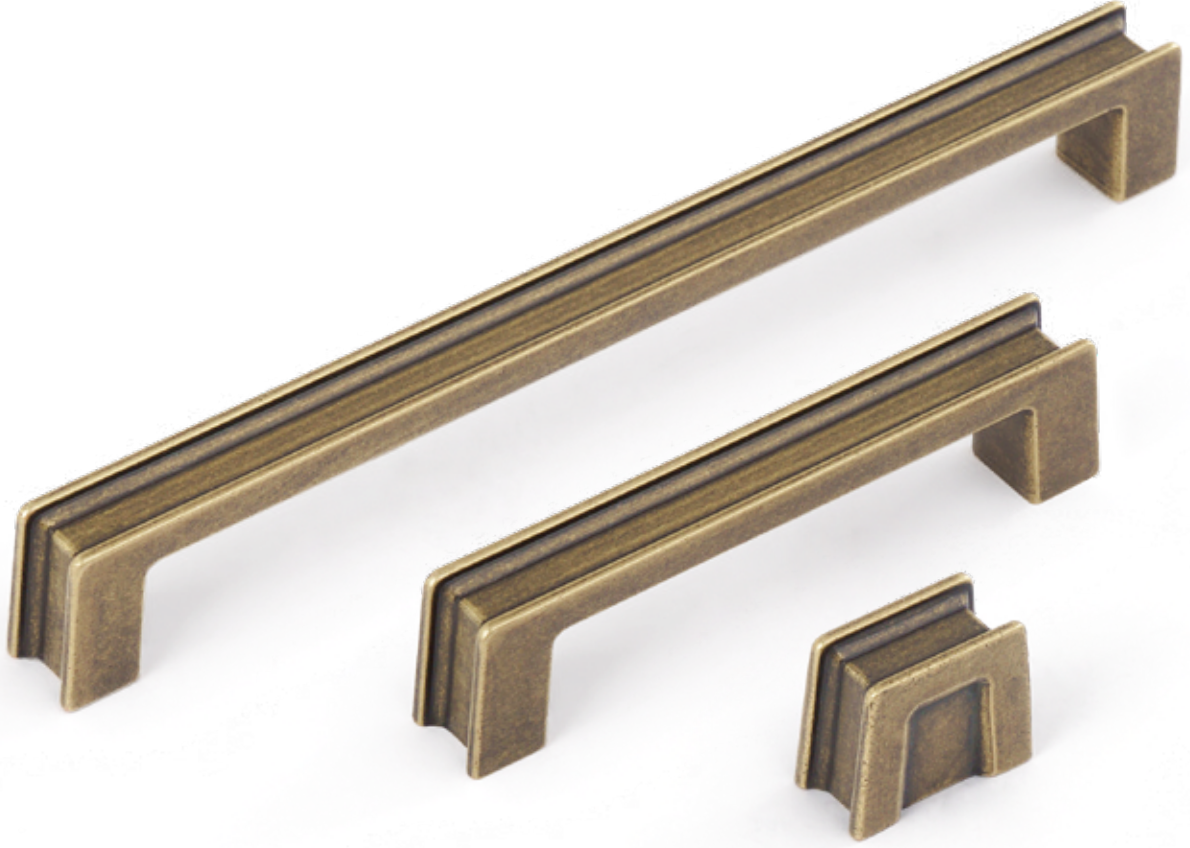
A 4140016Material
Zinc AlloyMateryal
Zamak

Kod	Uzunluk	Merkez	Genişlik	Yükseklik
Code	Length	Central	Width	Height
A1140192	208 mm	192 mm	16 mm	27 mm
A1140096	112 mm	96 mm	16 mm	27 mm
A4140016	32 mm	16mm	16 mm	27 mm

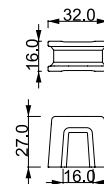
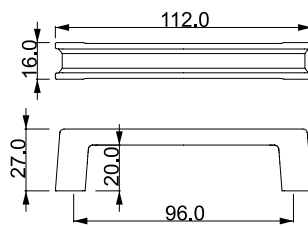
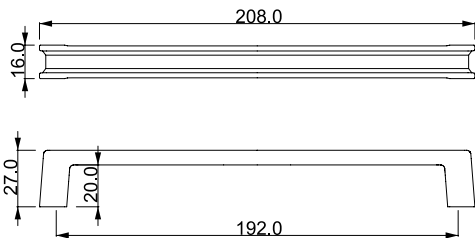
STANDARD FINISHES
STANDART RENKLERMP02
Chrome
KromPC24
Matt Black
Mat Siyah BoyaMP10
Antique Bronze
Antik BronzPC27
Matt Anthracite
Mat Antrasit BoyaPC35
Brushed Brass
Mat Sarı Boya

A 1126320
160
A 4126002
A 4126001



Material
Zinc Alloy

Materyal
Zamak

Kod	Uzunluk	Merkez	Genişlik	Yükseklik
Code	Length	Central	Width	Height
A1126320	349 mm	320 mm	14 mm	34 mm
A1126160	189 mm	160 mm	14 mm	34 mm
A4126002	40 mm	-	40 mm	30 mm
A4126001	20 mm	-	20 mm	30 mm

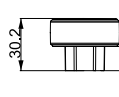
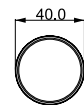
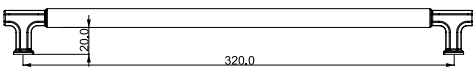
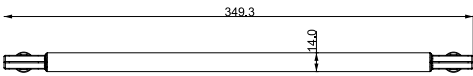
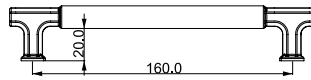
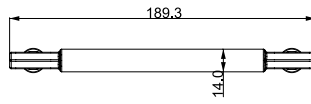

STANDARD FINISHES
STANDART RENKLER



A 1124320

256

192

A 4124016

Material
Zinc Alloy
AlMaterial
Zağnak
&
Alüminyum

Kod	Uzunluk	Merkez	Genişlik	Yükseklik
Code	Length	Central	Width	Height
A1124320	372 mm	320 mm	20 mm	40 mm
A1124256	308 mm	256 mm	20 mm	40 mm
A1124192	244 mm	192 mm	20 mm	40 mm
A4124016	60 mm	16 mm	22 mm	41 mm

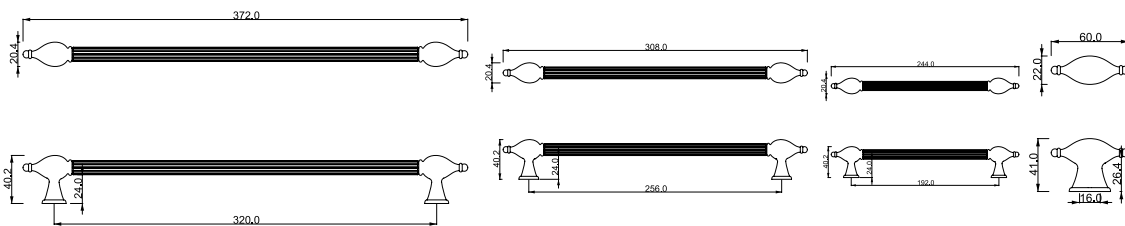
STANDARD FINISHES
STANDART RENKLERMP02
Chrome
KromPC24
Matt Black
Mat Siyah BoyaMP11
Gold
Altın RengiPC27
Matt Anthracite
Mat Antrasit BoyaMP30
Brushed Antique Brass
Fırçalanmış Antik PirinçPC35
Brushed Brass
Mat Sarı Boya

A 1121320
256
192
A 4121016



Material
Zinc Alloy
Al

Material
Zağnak
&
Alüminyum

Kod	Uzunluk	Merkez	Genişlik	Yükseklik
Code	Length	Central	Width	Height
A1121320	359 mm	320 mm	21 mm	38 mm
A1121256	295 mm	256 mm	21 mm	38 mm
A1121192	231 mm	192 mm	21 mm	38 mm
A4121016	50 mm	16 mm	21 mm	38 mm

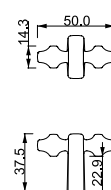
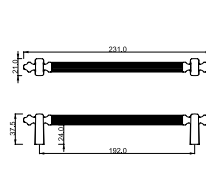
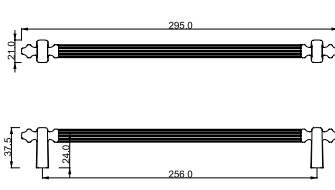
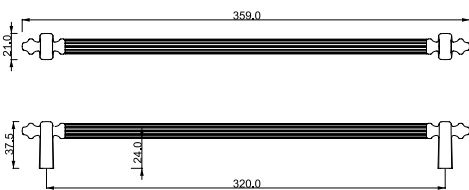

STANDARD FINISHES
STANDART RENKLER



MP02
Chrome
Krom



PC24
Matt Black
Mat Siyah Boya



MP11
Gold
Altın Rengi



PC27
Matt Anthracite
Mat Antrasit Boya



MP30
Brushed Antique Brass
Fırçalanmış Antik Pirinç



PC35
Brushed Brass
Mat Sarı Boya

A 1119320

256

192

A 4119016

Material
Zinc Alloy
&
AlMaterial
Zağnak
&
Alüminyum

Kod	Uzunluk	Merkez	Genişlik	Yükseklik
Code	Length	Central	Width	Height
A1119320	359 mm	320 mm	20 mm	36 mm
A1119256	296 mm	256 mm	20 mm	36 mm
A1119192	232 mm	192 mm	20 mm	36 mm
A4119016	50 mm	16 mm	20 mm	36 mm

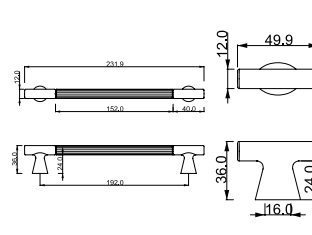
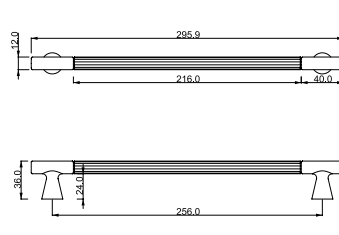
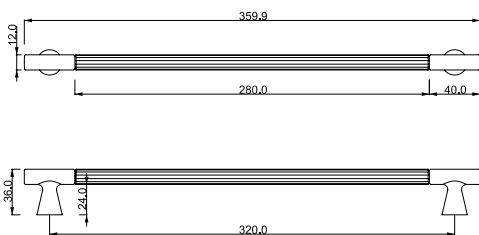
STANDARD FINISHES
STANDART RENKLERMP02
Chrome
KromPC24
Matt Black
Mat Siyah BoyaMP11
Gold
Altın RengiPC27
Matt Anthracite
Mat Antrasit BoyaMP30
Brushed Antique Brass
Fırçalanmış Antik PirinçPC35
Brushed Brass
Mat Sarı Boya

A 1117320
256
192
A 4117016



Material
Zinc Alloy
&
Al

Material
Zinc
&
Aluminum

Kod	Uzunluk	Merkez	Genişlik	Yükseklik
Code	Length	Central	Width	Height
A1117320	366 mm	320 mm	22 mm	37 mm
A1117256	302 mm	256 mm	22 mm	37 mm
A1117192	238 mm	192 mm	22 mm	37 mm
A4117016	56 mm	16 mm	22 mm	37 mm

STANDARD FINISHES
STANDART RENKLER

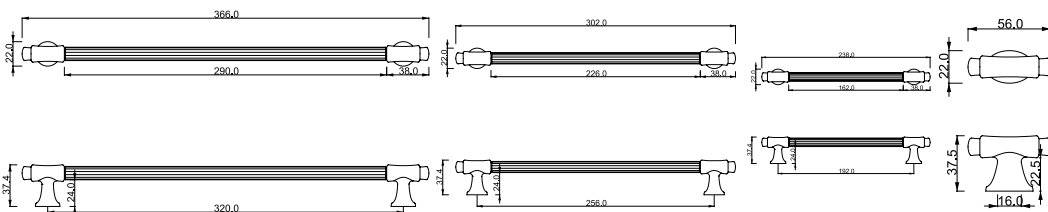

A 1113320

160

A 4113032

Material
Zinc AlloyMaterial
Zamak

Kod	Uzunluk	Merkez	Genişlik	Yükseklik
Code	Length	Central	Width	Height
A1113320	341 mm	320 mm	12 mm	30 mm
A1113160	181 mm	160 mm	12 mm	30 mm
A4113032	53 mm	32 mm	12 mm	30 mm

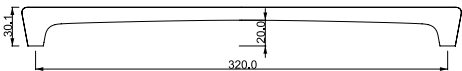
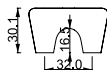
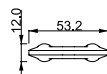
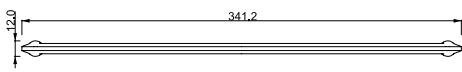
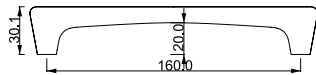
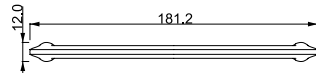
STANDARD FINISHES
STANDART RENKLERMP02
Chrome
KromPC24
Matt Black
Mat Siyah BoyaMP08
Bright Brushed Inox
Nikel SatinePC27
Matt Anthracite
Mat Antrasit BoyaPC35
Brushed Brass
Mat Sarı Boya

A 1111320

160

A 4111016

Material
Zinc AlloyMaterial
Zamak

Kod	Uzunluk	Merkez	Genişlik	Yükseklik
Code	Length	Central	Width	Height
A1111320	380 mm	320 mm	17 mm	30 mm
A1111160	220 mm	160 mm	17 mm	30 mm
A4111016	40 mm	16 mm	17 mm	26 mm

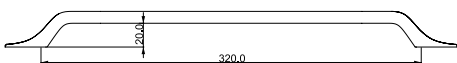
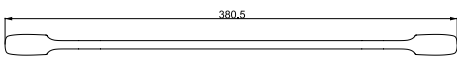
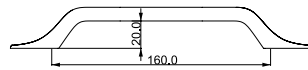
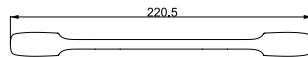
STANDARD FINISHES
STANDART RENKLERMP08
Bright Brushed Inox
Nikel SatinePC24
Matt Black
Mat Siyah BoyaMP11
Gold
Altın RengiPC27
Matt Anthracite
Mat Antrasit BoyaMP30
Brushed Antique Brass
Fırçalanmış Antik PirinçPC35
Brushed Brass
Mat Sarı Boya

A 1110320

192

096

A 4110016Material
Zinc AlloyMaterial
Zamak

Kod	Uzunluk	Merkez	Genişlik	Yükseklik
Code	Length	Central	Width	Height
A1110320	344 mm	320 mm	14 mm	30 mm
A1110192	216 mm	256 mm	14 mm	30 mm
A1110096	120 mm	192 mm	14 mm	30 mm
A4110016	60 mm	16 mm	16 mm	36 mm

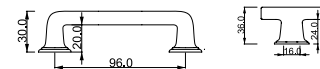
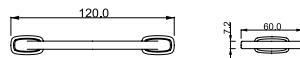
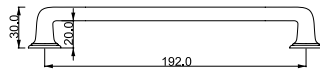
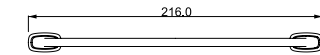
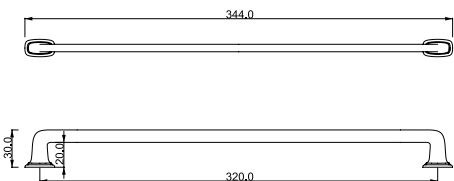
STANDARD FINISHES
STANDART RENKLERMP02
Chrome
KromPC24
Matt Black
Mat Siyah BoyaMP08
Bright Brushed Inox
Nikel SatinePC27
Matt Anthracite
Mat Antrasit BoyaPC35
Brushed Brass
Mat Sarı Boya

A 1109320
192
096

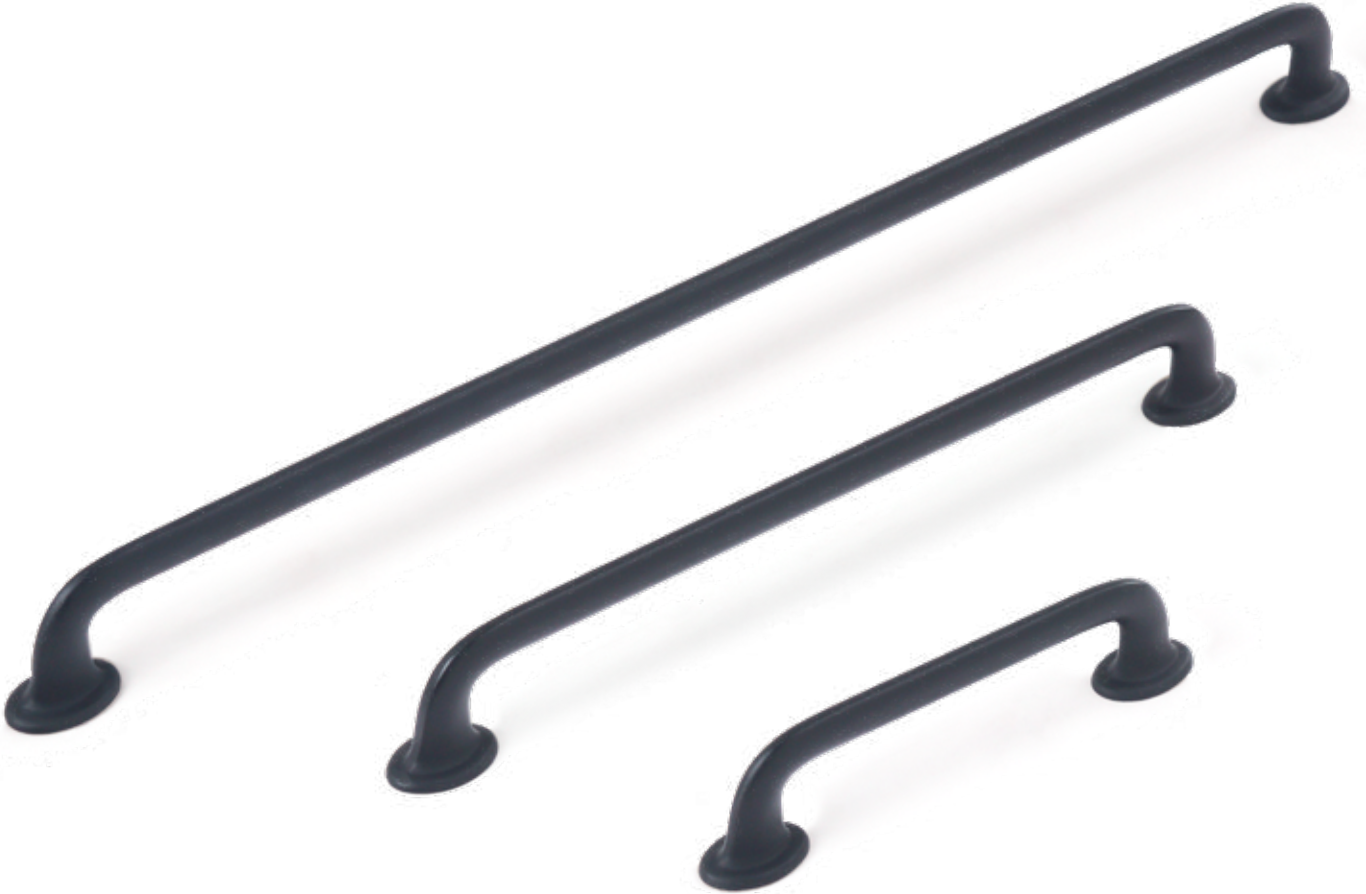

Material
Zinc Alloy

Materyal
Zamak

Kod	Uzunluk	Merkez	Genişlik	Yükseklik
Code	Length	Central	Width	Height
A1109320	344 mm	320 mm	16 mm	30 mm
A1109192	216 mm	192 mm	16 mm	30 mm
A1109096	120 mm	96 mm	16 mm	30 mm

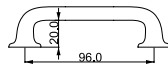
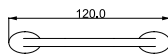
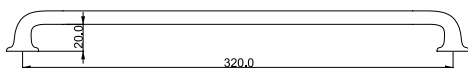
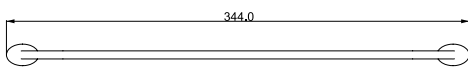
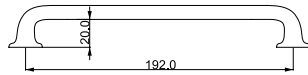
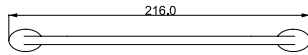

STANDARD FINISHES
STANDART RENKLER



MP02
Chrome
Krom



PC24
Matt Black
Mat Siyah Boya



MP08
Bright Brushed Inox
Nikel Satine



PC27
Matt Anthracite
Mat Antrasit Boya



PC35
Brushed Brass
Mat Sarı Boya

A 1108320

160

A 4108001

Material
Zinc AlloyMateriyal
Zamak

Kod	Uzunluk	Merkez	Genişlik	Yükseklik
Code	Length	Central	Width	Height
A1108320	370 mm	320 mm	19 mm	32 mm
A1108160	210 mm	160 mm	19 mm	32 mm
A4108001	50 mm	-	19 mm	32 mm

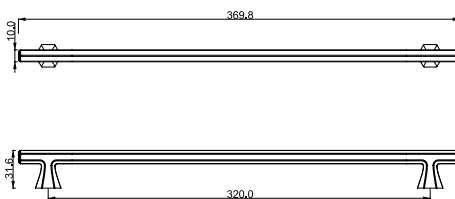
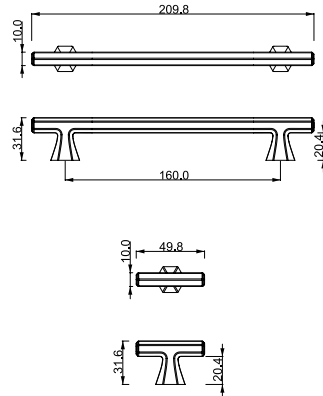
STANDARD FINISHES
STANDART RENKLERMP02
Chrome
KromPC24
Matt Black
Mat Siyah BoyaMP08
Bright Brushed Inox
Nikel SatinePC27
Matt Anthracite
Mat Antrasit BoyaMP11
Gold
Altın RengiPC35
Brushed Brass
Mat Sarı Boya

A 1107320
160
A 4107001



Material
Zinc Alloy

Materyal
Zamak

Kod	Uzunluk	Merkez	Genişlik	Yükseklik
Code	Length	Central	Width	Height
A1107320	336 mm	320 mm	16 mm	30 mm
A1107160	176 mm	160 mm	16 mm	30 mm
A4107001	54 mm	-	16 mm	30 mm

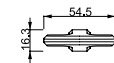
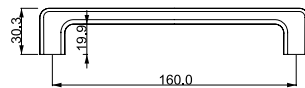
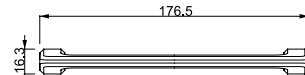
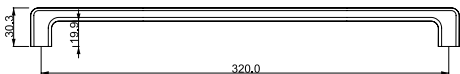
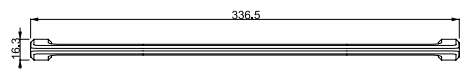

STANDARD FINISHES
STANDART RENKLER



MP02
Chrome
Krom



MP30
Brushed Antique Brass
Fırçalanmış Antik Pirinç



PC24
Matt Black
Mat Siyah Boya



MP08
Bright Brushed Inox
Nikel Satine



PC27
Matt Anthracite
Mat Antrasit Boya



MP11
Gold
Altın Rengi



PC35
Brushed Brass
Mat Sarı Boya

A 1106320

160

A 4106016

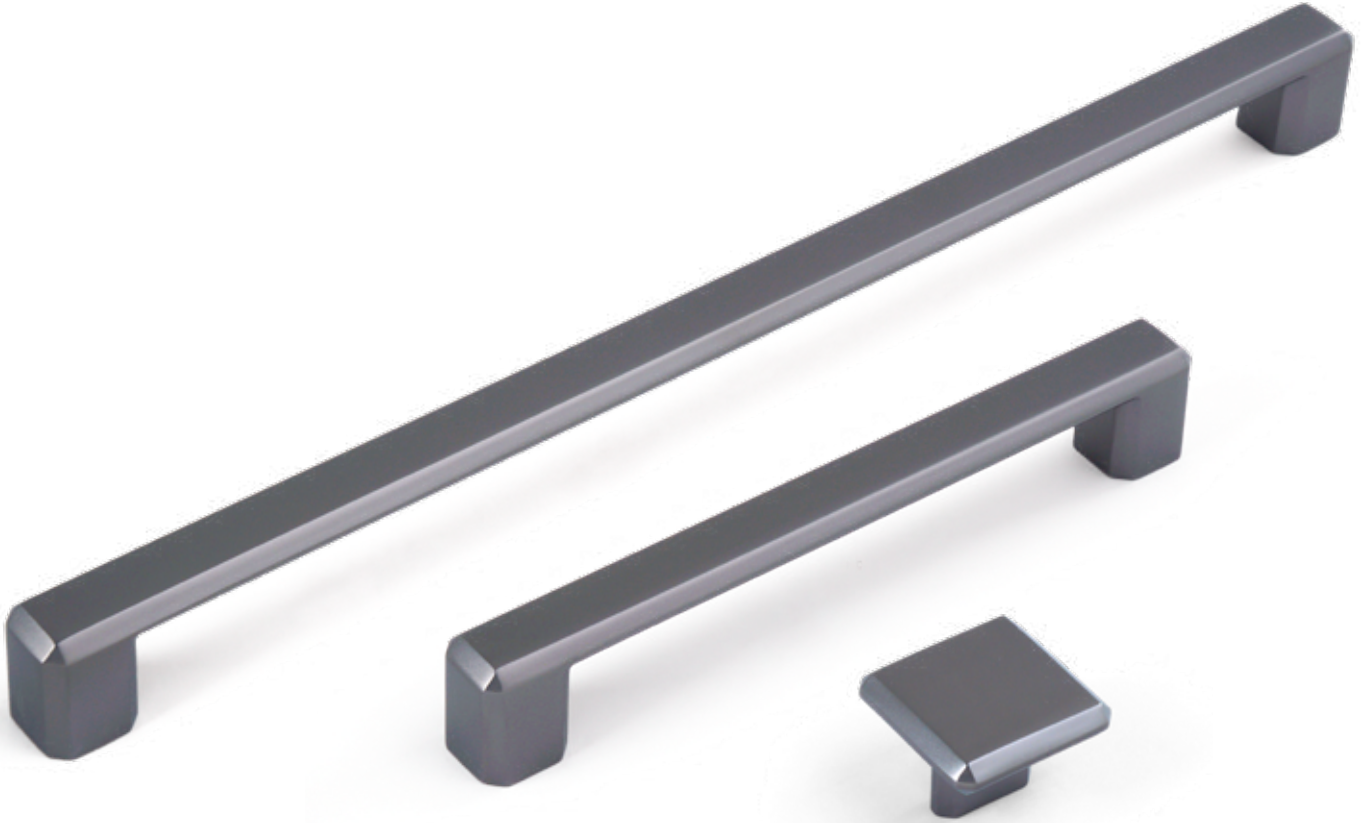
Material
Zinc AlloyMaterial
Zamak

Kod	Uzunluk	Merkez	Genişlik	Yükseklik
Code	Length	Central	Width	Height
A1106320	340 mm	320 mm	20 mm	28 mm
A1106160	180 mm	160 mm	20 mm	28 mm
A4106016	40 mm	16 mm	40 mm	28 mm

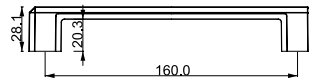
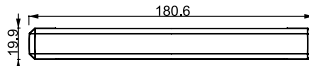
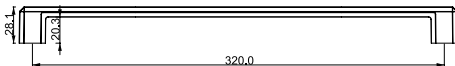
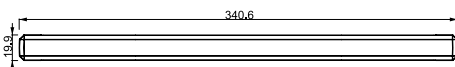
STANDARD FINISHES
STANDART RENKLERMP02
Chrome
KromPC24
Matt Black
Mat Siyah BoyaMP08
Bright Brushed Inox
Nikel SatinePC27
Matt Anthracite
Mat Antrasit BoyaPC35
Brushed Brass
Mat Sarı Boya

A 1105320

160

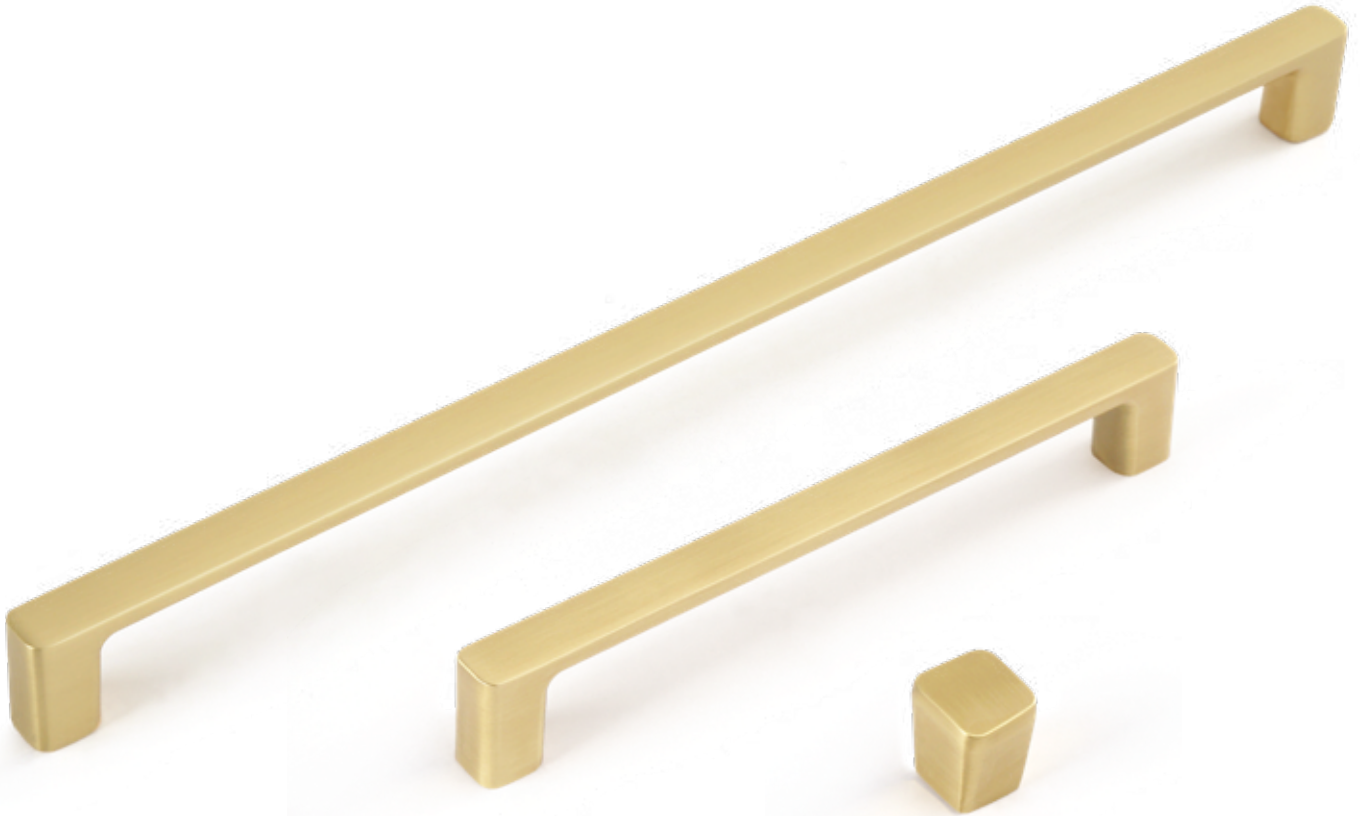
A 4105001Material
Zinc AlloyMateriyal
Zamak

Kod	Uzunluk	Merkez	Genişlik	Yükseklik
Code	Length	Central	Width	Height
A1105320	334 mm	320 mm	14 mm	26 mm
A1105160	175 mm	160 mm	14 mm	26 mm
A4105001	20 mm	-	20 mm	24 mm

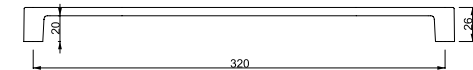
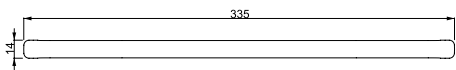
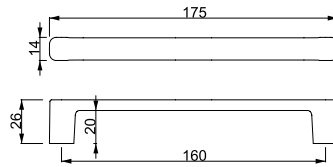
**STANDARD FINISHES**
STANDART RENKLER**MP02**
Chrome
Krom**PC24**
Matt Black
Mat Siyah Boya**MP08**
Bright Brushed Inox
Nikel Satine**PC27**
Matt Anthracite
Mat Antrasit Boya**MP30**
Brushed Antique Brass
Firçalanmış Antik Pirinç**PC35**
Brushed Brass
Mat Sarı Boya

A 1104320

160

A 4104016

Material
Zinc AlloyMateriyal
Zamak

Kod	Uzunluk	Merkez	Genişlik	Yükseklik
Code	Length	Central	Width	Height
A1104320	340 mm	320 mm	20 mm	28 mm
A1104160	180 mm	160 mm	20 mm	28 mm
A4104016	61 mm	16 mm	20 mm	28 mm

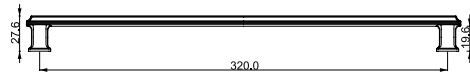
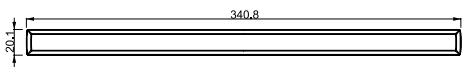
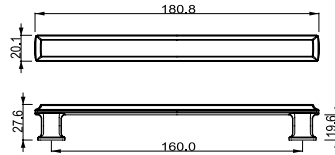
STANDARD FINISHES
STANDART RENKLERMP02
Chrome
KromPC24
Matt Black
Mat Siyah BoyaMP11
Gold
Altın RengiPC27
Matt Anthracite
Mat Antrasit BoyaMP30
Brushed Antique Brass
Fırçalanmış Antik PirinçPC35
Brushed Brass
Mat Sarı Boya

A 1103320
160
A 4103001

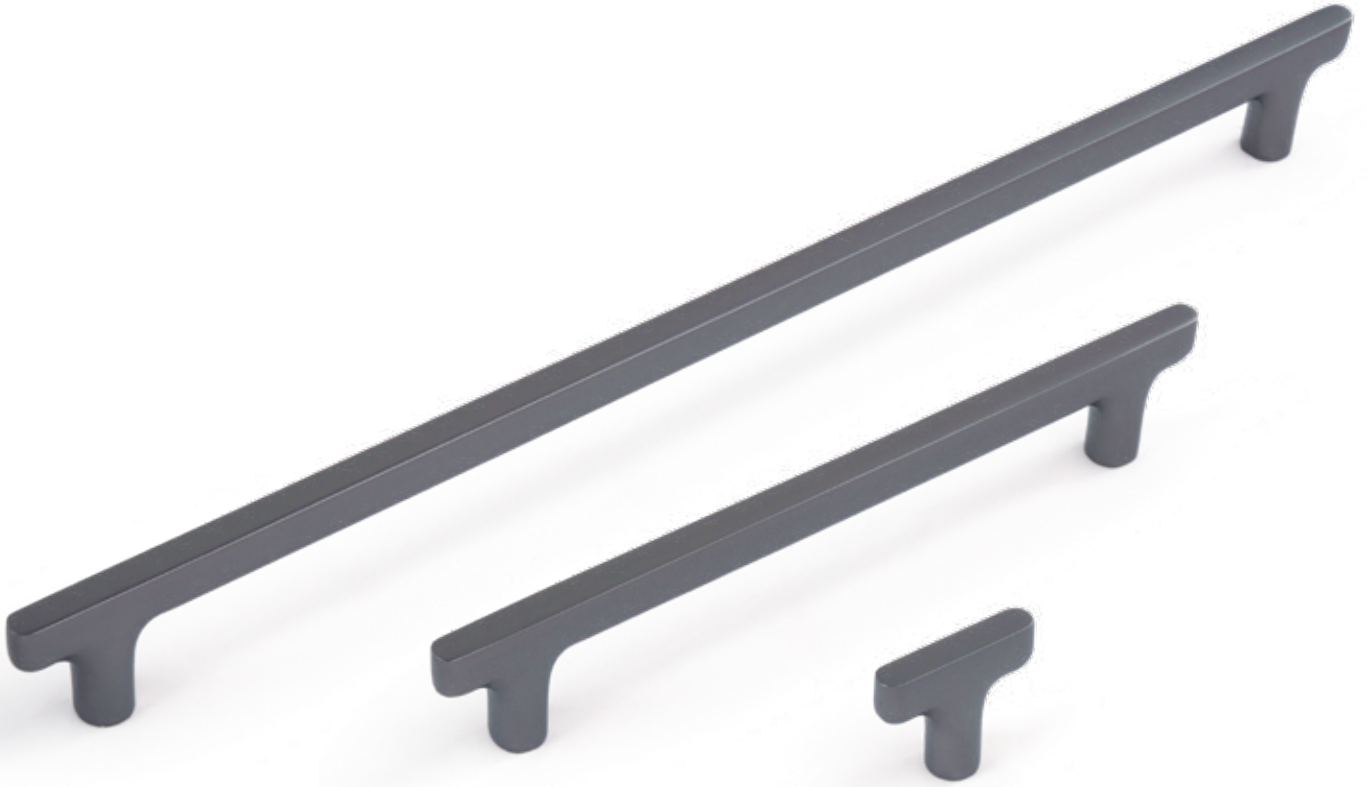

Material
Zinc Alloy

Materyal
Zamak

Kod	Uzunluk	Merkez	Genişlik	Yükseklik
Code	Length	Central	Width	Height
A1103320	360 mm	320 mm	8 mm	33 mm
A1103160	201 mm	160 mm	8 mm	33 mm
A4103001	40 mm	-	8 mm	33 mm

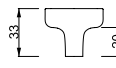
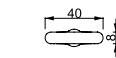
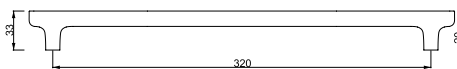
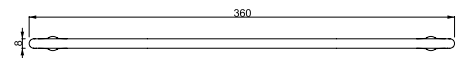
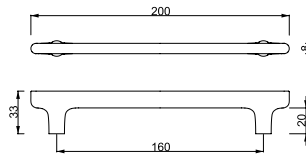

STANDARD FINISHES STANDART RENKLER



MP02
Chrome
Krom



PC24
Matt Black
Mat Siyah Boya



MP08
Bright Brushed Inox
Nikel Satine



PC27
Matt Anthracite
Mat Antrasit Boya



PC35
Brushed Brass
Mat Sarı Boya

A 1102320

160

A 4102003**A 4102002****A 4102001**Material
Zinc AlloyMateryal
Zamak

Kod	Uzunluk	Merkez	Genişlik	Yükseklik
Code	Length	Central	Width	Height
A1102320	340 mm	320 mm	20 mm	28 mm
A1102160	180 mm	160 mm	20 mm	28 mm
A4102003	60 mm	-	60 mm	22 mm
A4102002	45 mm	-	45 mm	22 mm
A4102001	30 mm	-	30 mm	22 mm

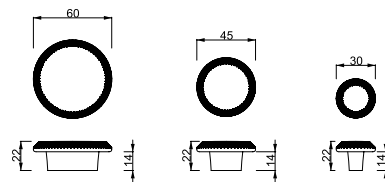
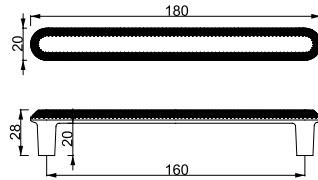
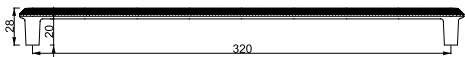
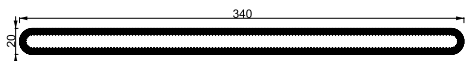
STANDARD FINISHES
STANDART RENKLERMP02
Chrome
KromPC24
Matt Black
Mat Siyah BoyaMP11
Gold
Altın RengiPC27
Matt Anthracite
Mat Antrasit BoyaMP30
Brushed Antique Brass
Fırçalanmış Antik PirinçPC35
Brushed Brass
Mat Sarı Boya

A 1101192

096

A 4101016



Material
Zinc Alloy

Materyal
Zamak

Kod	Uzunluk	Merkez	Genişlik	Yükseklik
Code	Length	Central	Width	Height
A1101192	211 mm	192 mm	19 mm	27 mm
A1101096	115 mm	96 mm	19 mm	27 mm
A4101016	59 mm	16 mm	19 mm	27 mm

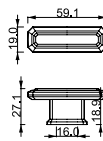
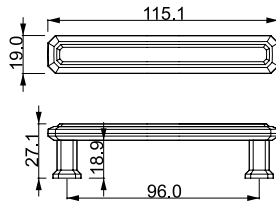
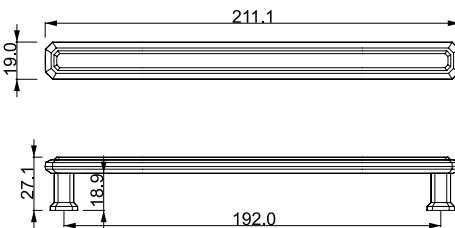

STANDARD FINISHES
STANDART RENKLER



A 372160
096
016



Material
Zinc Alloy

Material
Zamak

Kod	Uzunluk	Merkez	Genişlik	Yükseklik
Code	Length	Central	Width	Height
A372160	211 mm	160 mm	20 mm	27 mm
A372096	147 mm	96 mm	20 mm	27 mm
A372016	51 mm	16 mm	20 mm	25 mm

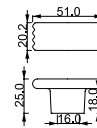
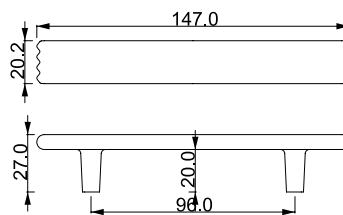
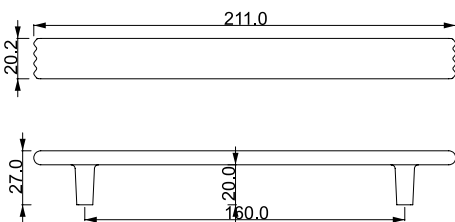

STANDARD FINISHES
STANDART RENKLER



MP02
Chrome
Krom



PC24
Matt Black
Mat Siyah Boya



MP08
Bright Brushed Inox
Nikel Satine



PC27
Matt Anthracite
Mat Antrasit Boya

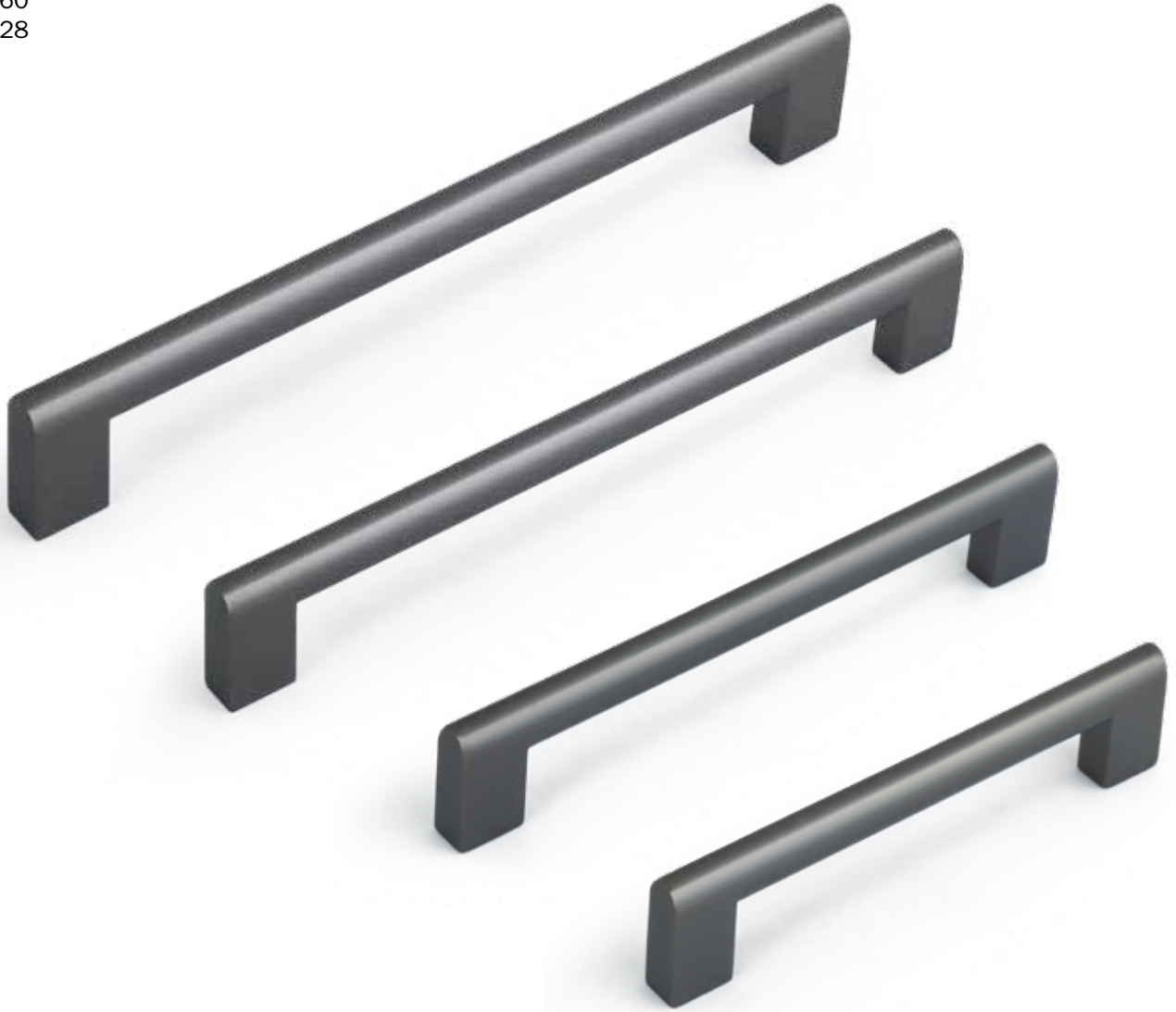

PC35
Brushed Brass
Mat Sarı Boya

A 204224192
160
128Material
Zinc AlloyMaterial
Zamak

Kod	Uzunluk	Merkez	Genişlik	Yükseklik
Code	Length	Central	Width	Height
A204224	241 mm	224 mm	8,5 mm	35 mm
A204192	209 mm	192 mm	8,5 mm	35 mm
A204160	177 mm	160 mm	8,5 mm	35 mm
A204128	145 mm	128 mm	8,5 mm	35 mm

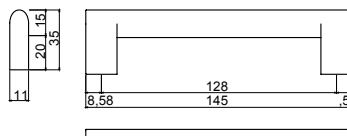
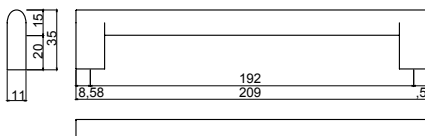
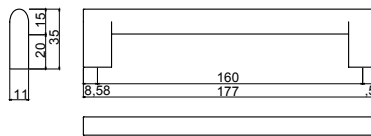
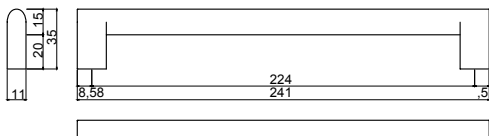
**STANDARD FINISHES**
STANDART RENKLERMP02
Chrome
KromPC24
Matt Black
Mat Siyah BoyaMP19
Brushed Chrome
Krom SatinePC27
Matt Anthracite
Mat Antrasit BoyaMP08
Bright Brushed Inox
Nikel SatinePC35
Brushed Brass
Mat Sarı Boya

A 186192160
128
064Material
Zinc AlloyMateryal
Zamak

Kod	Uzunluk	Merkez	Genişlik	Yükseklik
Code	Length	Central	Width	Height
A186192	217,3 mm	192 mm	7,8 mm	26,5 mm
A186160	185,3 mm	160 mm	7,8 mm	26,5 mm
A186128	154 mm	128 mm	7,8 mm	26,5 mm
A186064	92 mm	064 mm	7,8 mm	26,5 mm

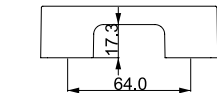
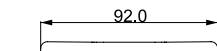
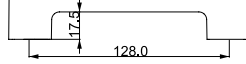
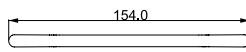
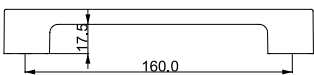
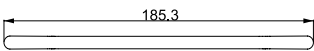
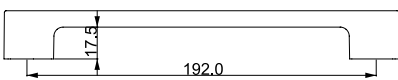
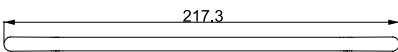
STANDARD FINISHES
STANDART RENKLERMP02
Chrome
KromPC24
Matt Black
Mat Siyah BoyaMP08
Bright Brushed Inox
Nikel SatinePC27
Matt Anthracite
Mat Antrasit BoyaPC35
Brushed Brass
Mat Sarı Boya

B 967384
288
192

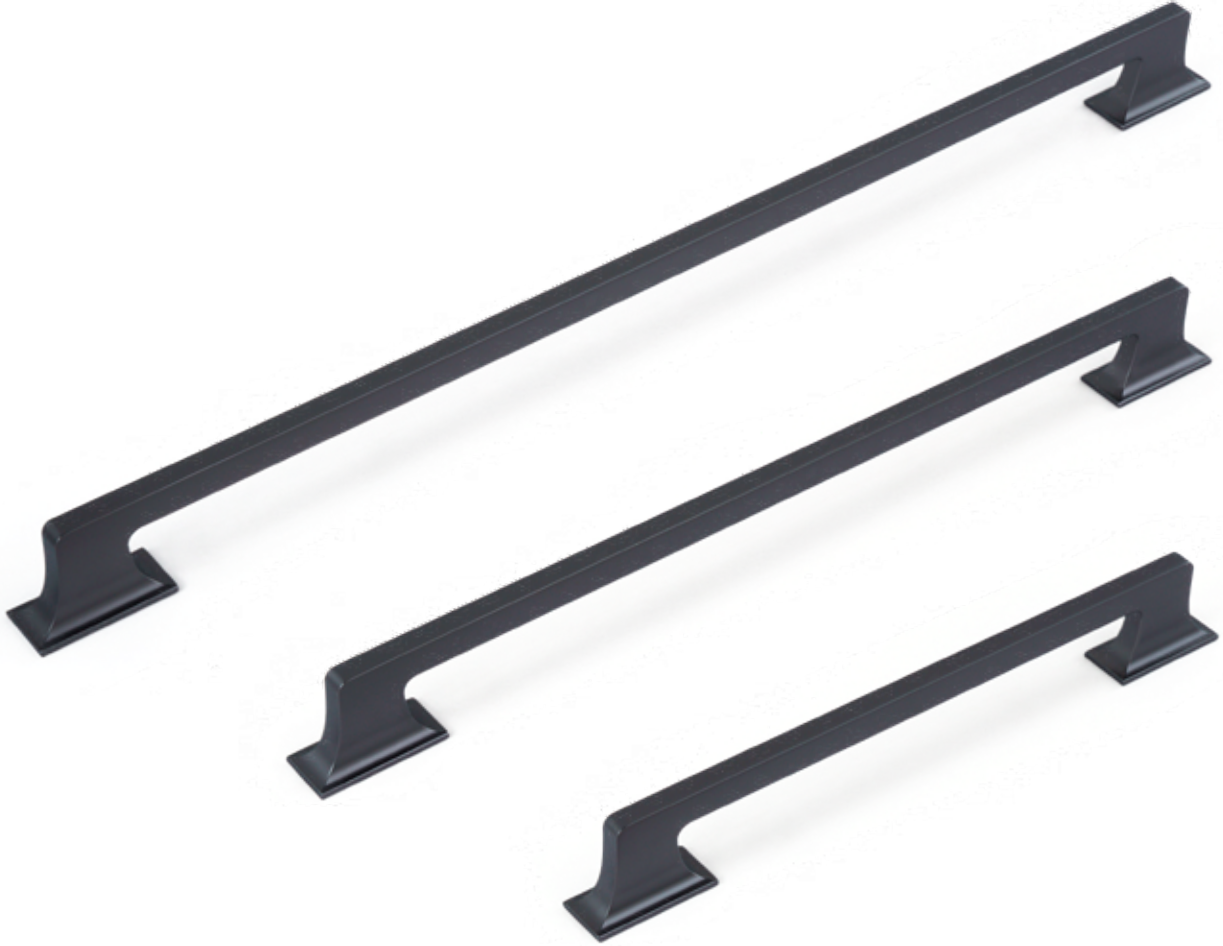

Material
Aluminum

Materyal
Alüminyum

Kod	Uzunluk	Merkez	Genişlik	Yükseklik
Code	Length	Central	Width	Height
B967384	424 mm	384 mm	18 mm	32 mm
B967288	328 mm	288 mm	18 mm	32 mm
B967192	232 mm	192 mm	18 mm	32 mm

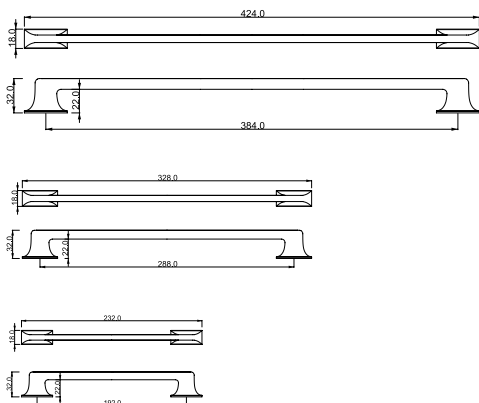

STANDARD FINISHES
STANDART RENKLER



MP02
Chrome
Krom



PC24
Matt Black
Mat Siyah Boya



MP08
Bright Brushed Inox
Nikel Satine



PC27
Matt Anthracite
Mat Antrasit Boya

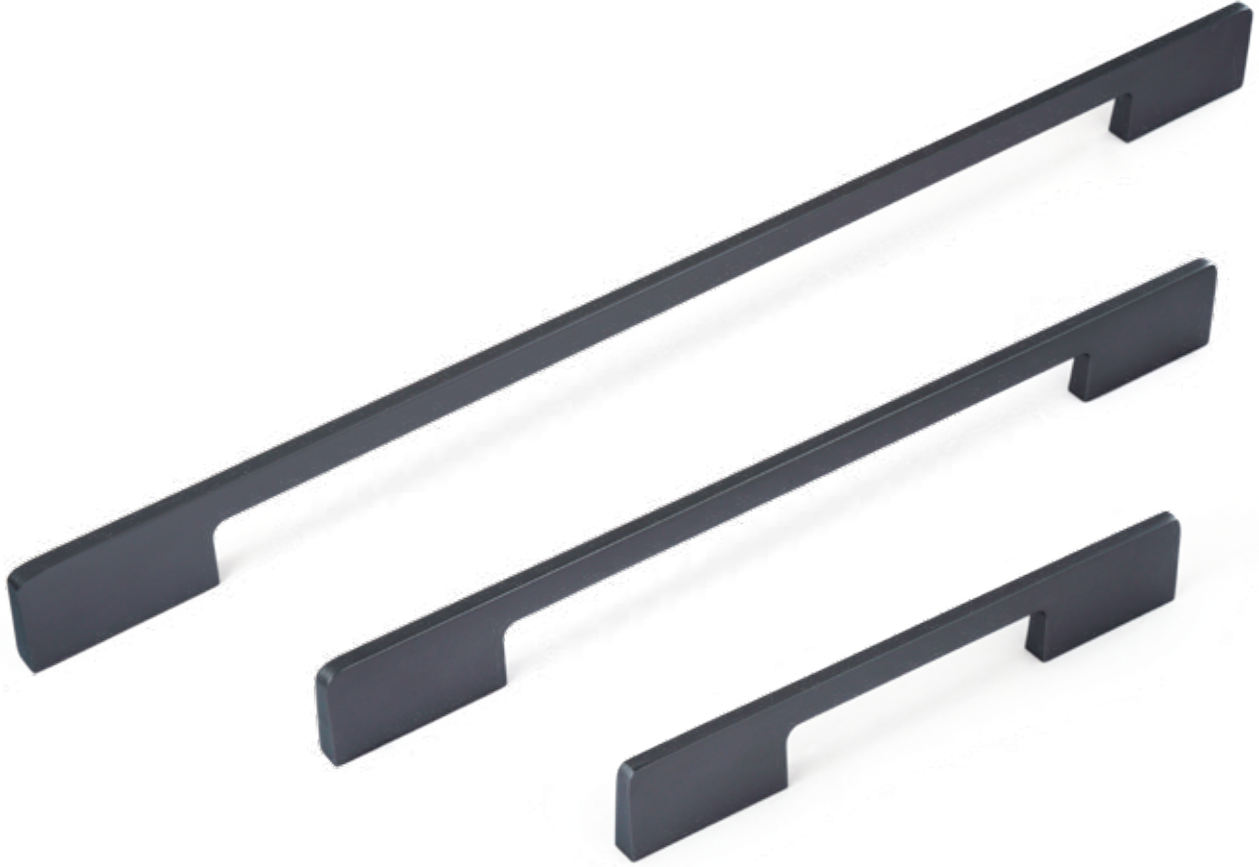

PC35
Brushed Brass
Mat Sarı Boya

B 959448
320
192Material
AluminumMaterial
Alüminyum

Kod	Uzunluk	Merkez	Genişlik	Yükseklik
Code	Length	Central	Width	Height
B959448	476 mm	448 mm	10 mm	34 mm
B959320	348 mm	320 mm	10 mm	34 mm
B959192	220mm	192 mm	10 mm	34 mm

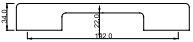
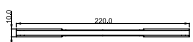
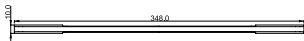
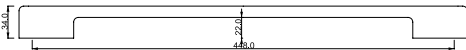
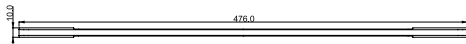
STANDARD FINISHES
STANDART RENKLERMP02
Chrome
KromPC24
Matt Black
Mat Siyah BoyaMP08
Bright Brushed Inox
Nikel SatinePC27
Matt Anthracite
Mat Antrasit BoyaPC35
Brushed Brass
Mat Sarı Boya



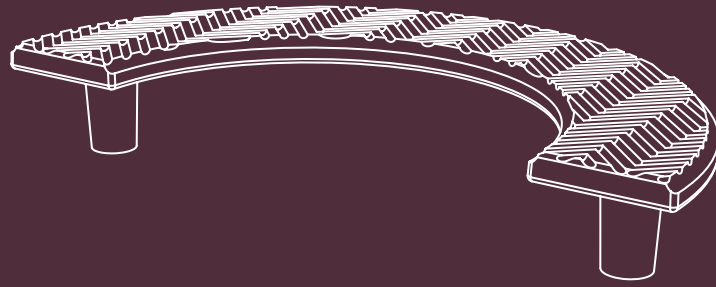

SYMMETRICAL FURNITURE
HANDLES & KNOBS
SİMETRİK MOBİLYA
KULPLARI VE DÜĞMELERİ

Discover new passions

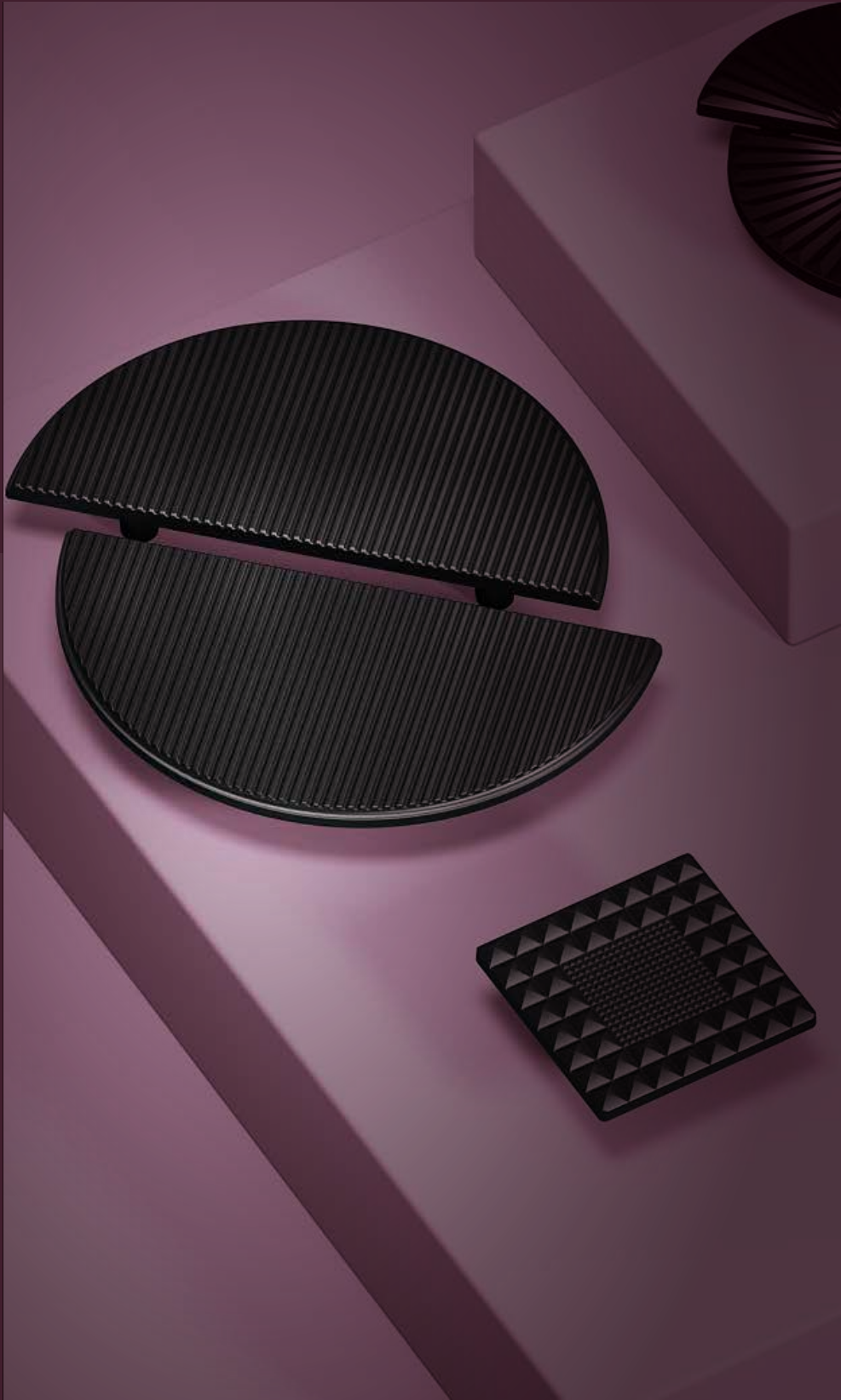

A 1207192

160

064

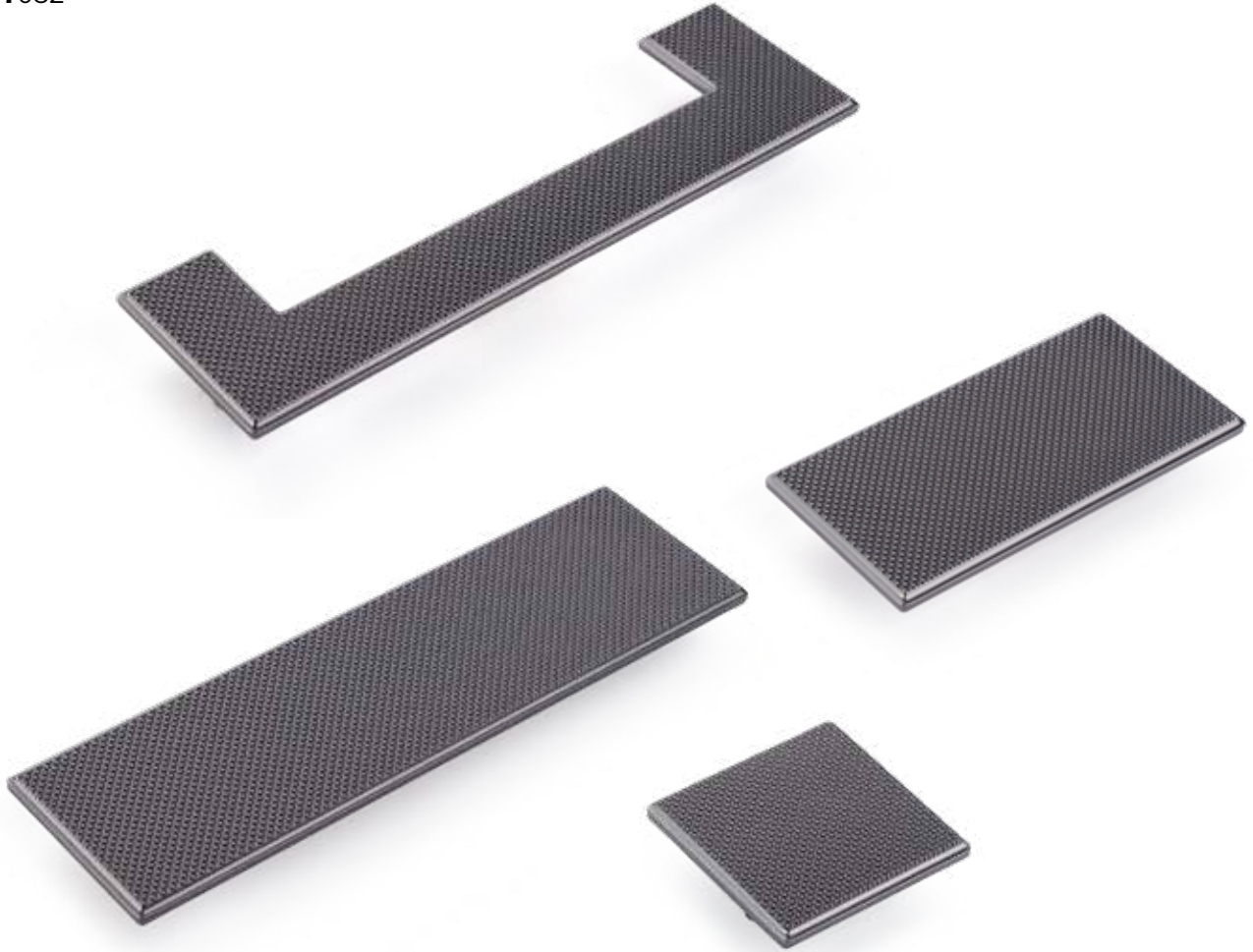
A 4207032Material
Zinc AlloyMateryal
Zamak

Kod	Uzunluk	Merkez	Genişlik	Yükseklik
Code	Length	Central	Width	Height
A1207192	224 mm	192 mm	64 mm	26 mm
A1207160	224 mm	160 mm	64 mm	26 mm
A1207064	128 mm	64 mm	64 mm	26 mm
A4207032	64 mm	32 mm	64 mm	26 mm

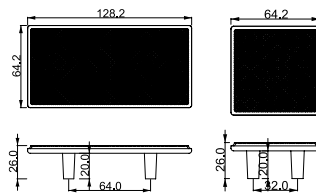
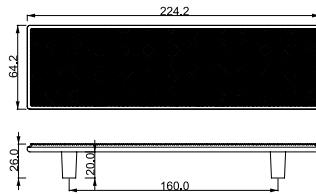
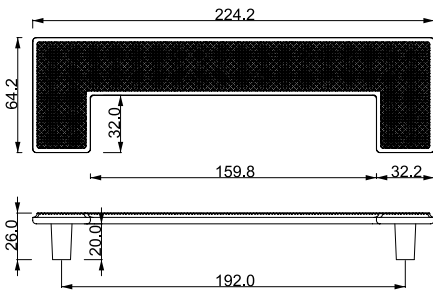
STANDARD FINISHES
STANDART RENKLERMP02
Chrome
KromPC24
Matt Black
Mat Siyah BoyaMP11
Gold
Altın RengiPC27
Matt Anthracite
Mat Antrasit BoyaMP30
Brushed Antique Brass
Firçalanmış Antik PirinçPC35
Brushed Brass
Mat Sarı Boya

A 1206192
160
064
A 4206032

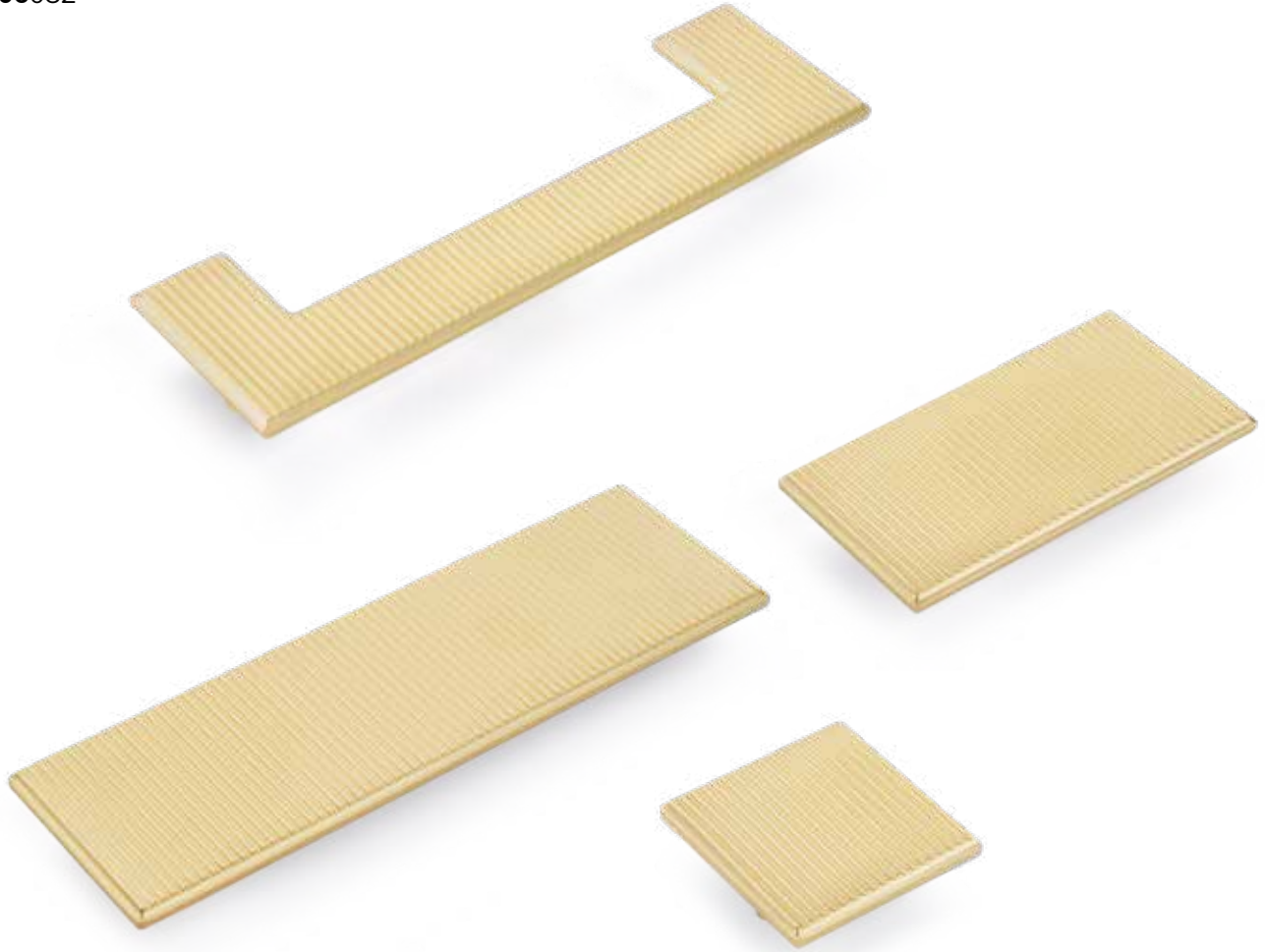

Material
Zinc Alloy

Materyal
Zamak

Kod	Uzunluk	Merkez	Genişlik	Yükseklik
Code	Length	Central	Width	Height
A1206192	224 mm	192 mm	64 mm	26 mm
A1206160	224 mm	160 mm	64 mm	26 mm
A1206064	128 mm	64 mm	64 mm	26 mm
A4206032	64 mm	32 mm	64 mm	26 mm

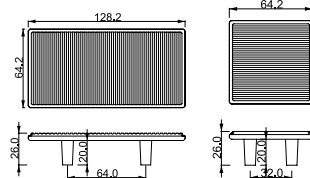
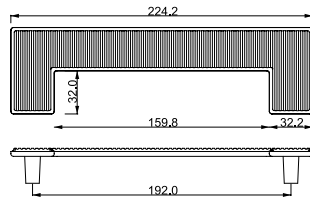
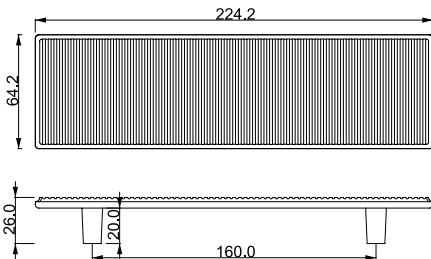

STANDARD FINISHES STANDART RENKLER



MP02
Chrome
Krom



PC24
Matt Black
Mat Siyah Boya



MP11
Gold
Altın Rengi



PC27
Matt Anthracite
Mat Antrasit Boya



MP30
Brushed Antique Brass
Fırçalanmış Antik Pirinç



PC35
Brushed Brass
Mat Sarı Boya

A 1205192

160

064

A 4205032

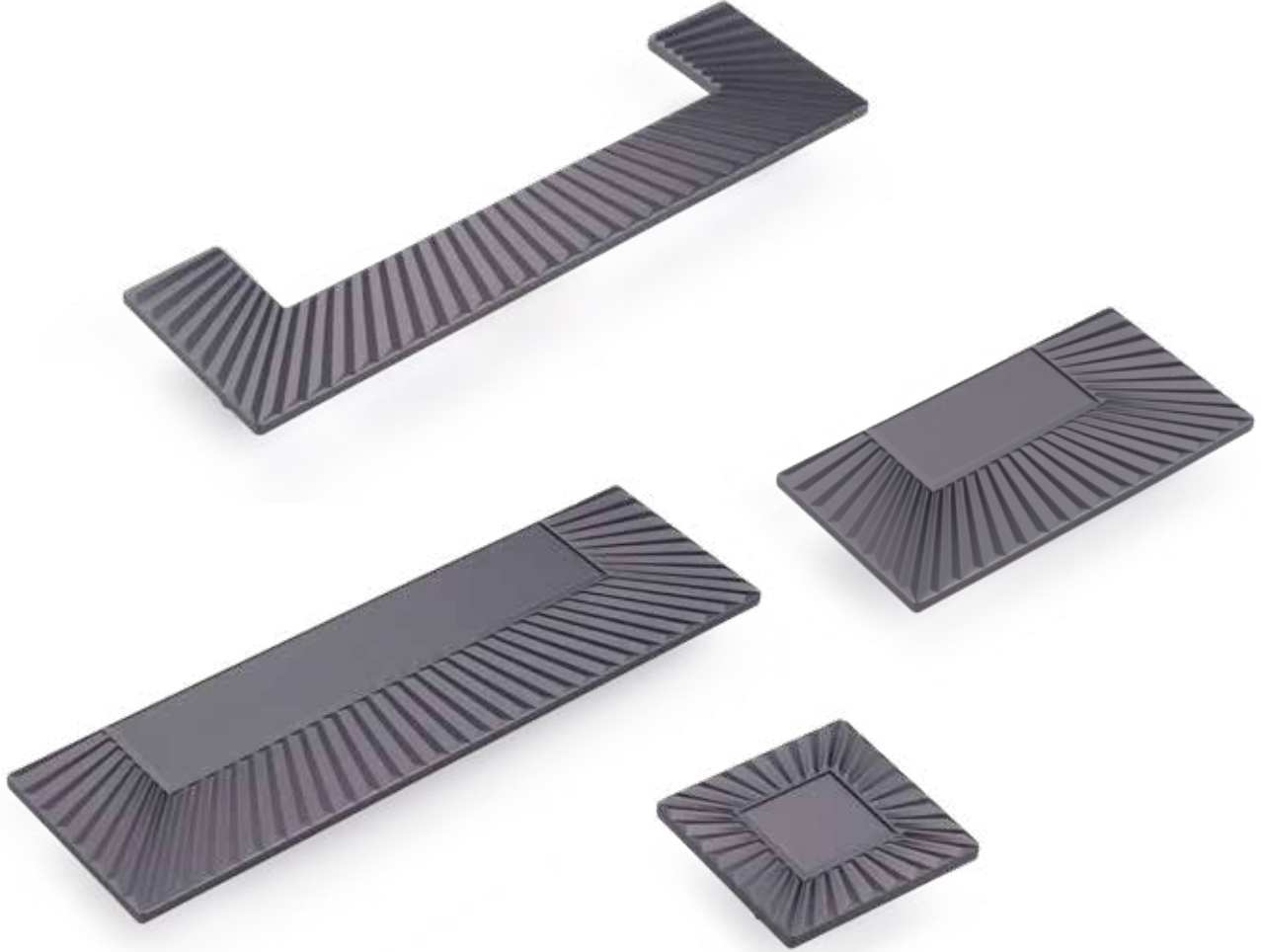

Material
Zinc Alloy

Materyal
Zamak

Kod	Uzunluk	Merkez	Genişlik	Yükseklik
Code	Length	Central	Width	Height
A1205192	224 mm	192 mm	64 mm	26 mm
A1205160	224 mm	160 mm	64 mm	26 mm
A1205064	128 mm	64 mm	64 mm	26 mm
A4205032	64 mm	32 mm	64 mm	26 mm

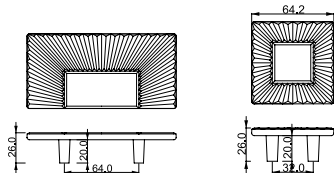
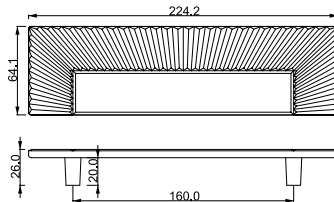
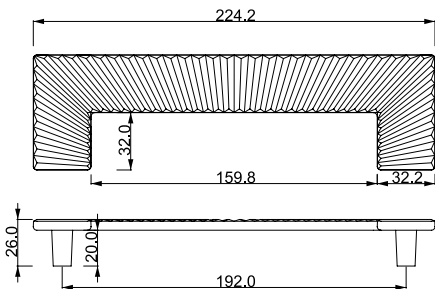

STANDARD FINISHES
STANDART RENKLER



MP02
Chrome
Krom



PC24
Matt Black
Mat Siyah Boya



MP11
Gold
Altın Rengi



PC27
Matt Anthracite
Mat Antrasit Boya



MP30
Brushed Antique Brass
Fırçalanmış Antik Pirinç



PC35
Brushed Brass
Mat Sarı Boya

A 1204192
160
064
A 4204032

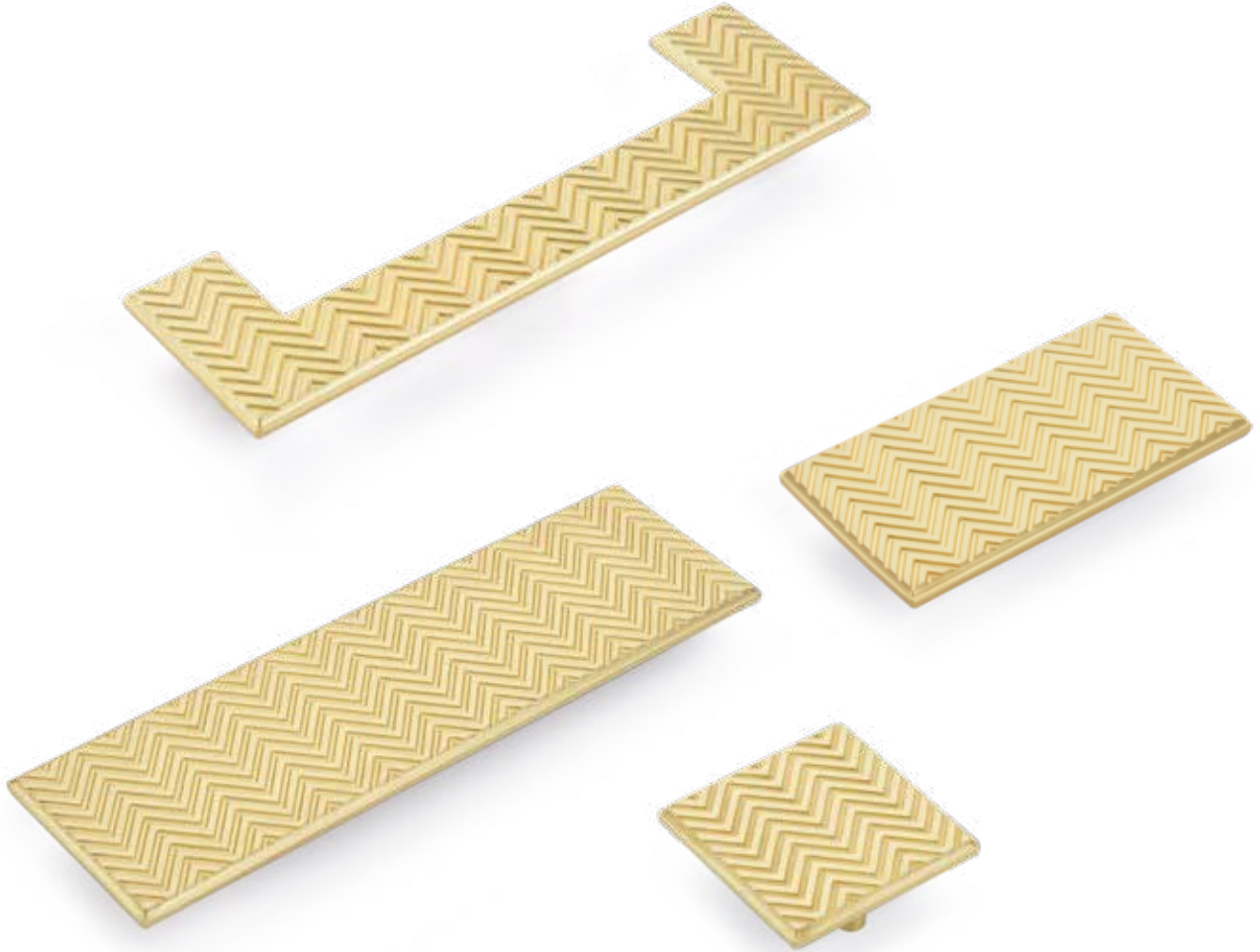

Material
Zinc Alloy

Materyal
Zamak

Kod	Uzunluk	Merkez	Genişlik	Yükseklik
Code	Length	Central	Width	Height
A1204192	224 mm	192 mm	64 mm	26 mm
A1204160	224 mm	160 mm	64 mm	26 mm
A1204064	128 mm	64 mm	64 mm	26 mm
A4204032	64 mm	32 mm	64 mm	26 mm

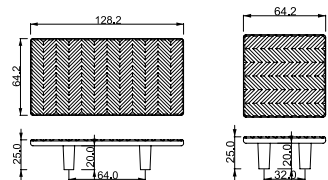
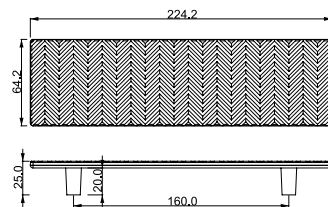
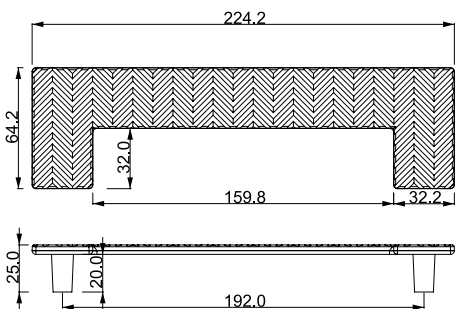

STANDARD FINISHES STANDART RENKLER



MP02
Chrome
Krom



PC24
Matt Black
Mat Siyah Boya



MP11
Gold
Altın Rengi



PC27
Matt Anthracite
Mat Antrasit Boya



MP30
Brushed Antique Brass
Fırçalanmış Antik Pirinç



PC35
Brushed Brass
Mat Sarı Boya

A 1203544
192
160
064
A 4203032



Material
Zinc Alloy

Materyal
Zamak

Kod	Uzunluk	Merkez	Genişlik	Yükseklik
Code	Length	Central	Width	Height
A1203544	512 mm	544 mm	64 mm	29 mm
A1203192	224 mm	192 mm	64 mm	26 mm
A1203160	224 mm	160 mm	64 mm	26 mm
A1203064	128 mm	64 mm	64 mm	26 mm
A4203032	64 mm	32 mm	64 mm	26 mm

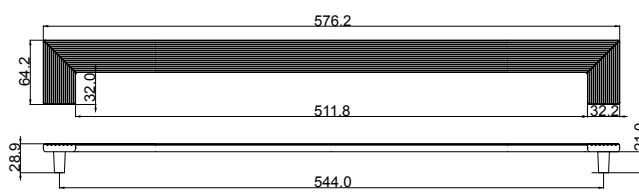
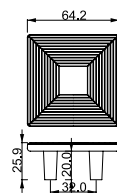
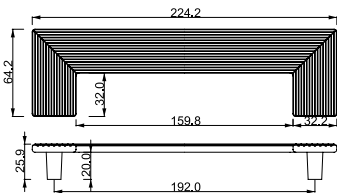
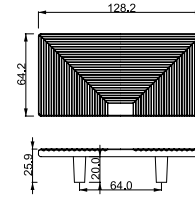
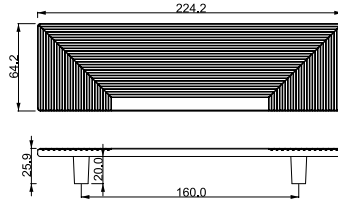

STANDARD FINISHES
STANDART RENKLER



MP02
Chrome
Krom



PC24
Matt Black
Mat Siyah Boya



MP11
Gold
Altın Rengi



PC27
Matt Anthracite
Mat Antrasit Boya



MP30
Brushed Antique Brass
Fırçalanmış Antik Pirinç



PC35
Brushed Brass
Mat Sarı Boya

A 1202192
160
064
A 4202032

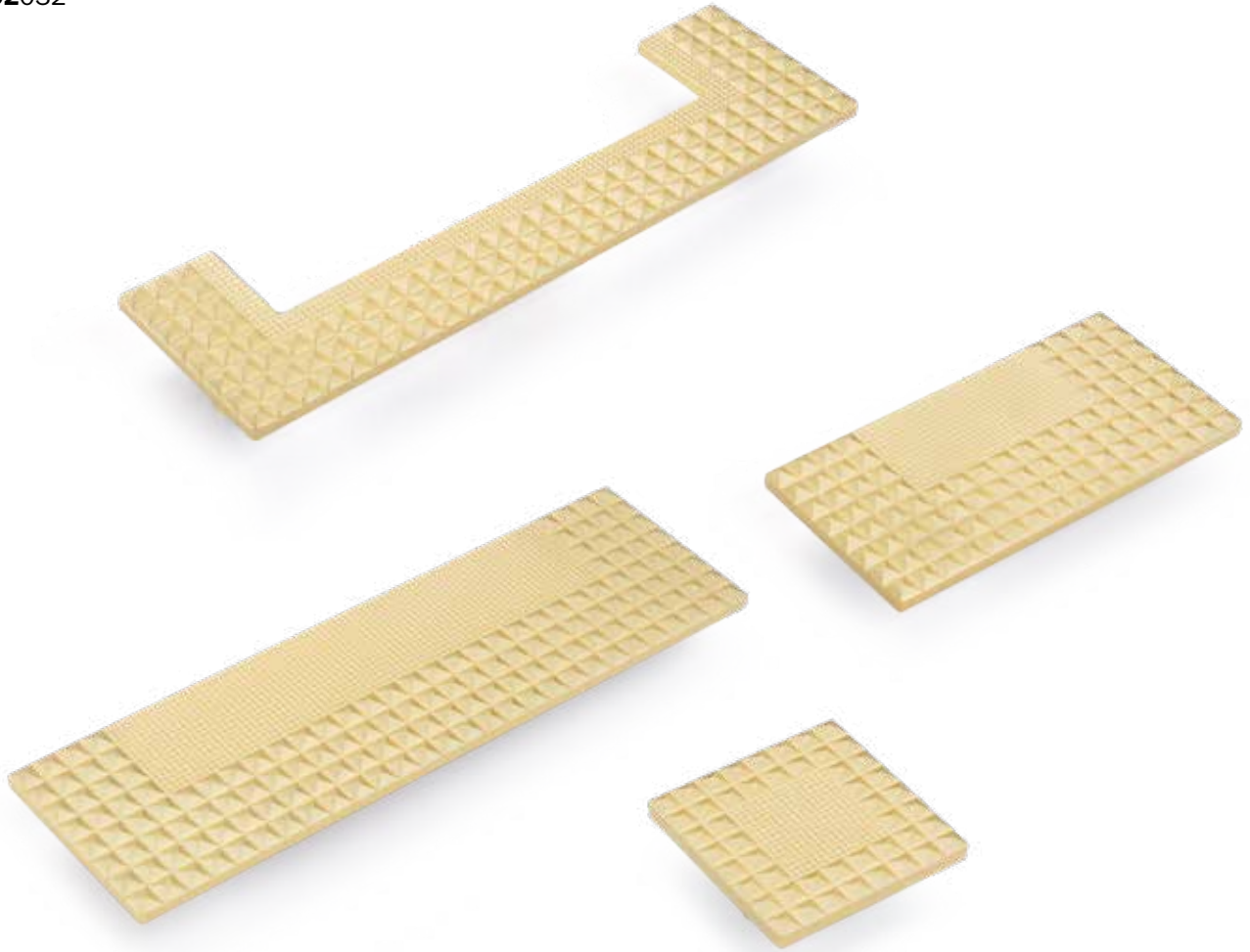

Material
Zinc Alloy

Materyal
Zamak

Kod	Uzunluk	Merkez	Genişlik	Yükseklik
Code	Length	Central	Width	Height
A1202192	224 mm	192 mm	64 mm	26 mm
A1202160	224 mm	160 mm	64 mm	26 mm
A1202064	128 mm	64 mm	64 mm	26 mm
A4202032	64 mm	32 mm	64 mm	26 mm

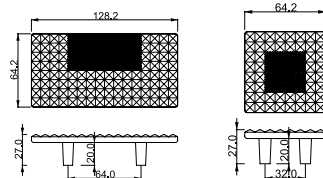
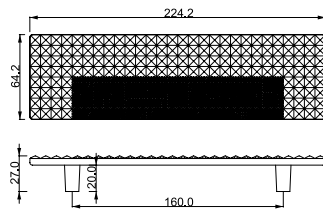
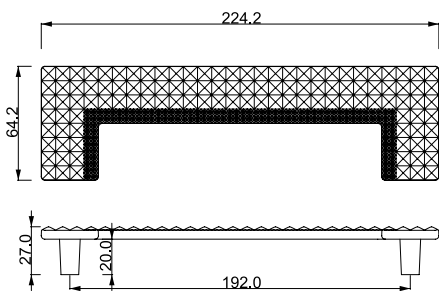

STANDARD FINISHES
STANDART RENKLER



MP02
Chrome
Krom



PC24
Matt Black
Mat Siyah Boya



MP11
Gold
Altın Rengi



PC27
Matt Anthracite
Mat Antrasit Boya



MP30
Brushed Antique Brass
Fırçalanmış Antik Pirinç



PC35
Brushed Brass
Mat Sarı Boya

A 1201192

160

064

A 4201032Material
Zinc AlloyMateryal
Zamak

Kod	Uzunluk	Merkez	Genişlik	Yükseklik
Code	Length	Central	Width	Height
A1201192	224 mm	192 mm	64 mm	26 mm
A1201160	224 mm	160 mm	64 mm	26 mm
A1201064	128 mm	64 mm	64 mm	26 mm
A4201032	64 mm	32 mm	64 mm	26 mm

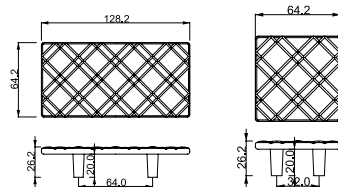
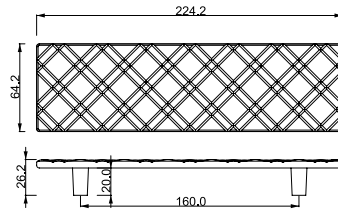
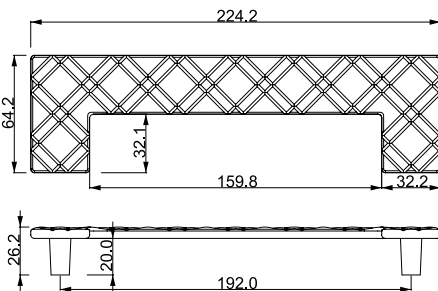
STANDARD FINISHES
STANDART RENKLERMP02
Chrome
KromPC24
Matt Black
Mat Siyah BoyaMP11
Gold
Altın RengiPC27
Matt Anthracite
Mat Antrasit BoyaMP30
Brushed Antique Brass
Firçalanmış Antik PırnçPC35
Brushed Brass
Mat Sarı Boya

A 1198128

096

064

A 4198016Material
Zinc AlloyMateryal
Zamak

Kod	Uzunluk	Merkez	Genişlik	Yükseklik
Code	Length	Central	Width	Height
A1198128	160 mm	128 mm	80 mm	25 mm
A1198096	160 mm	96 mm	80 mm	25 mm
A1198064	100 mm	64 mm	50 mm	26 mm
A4198016	60 mm	16 mm	60 mm	26 mm

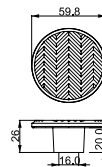
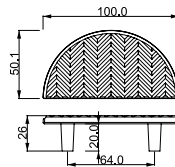
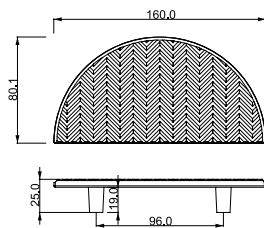
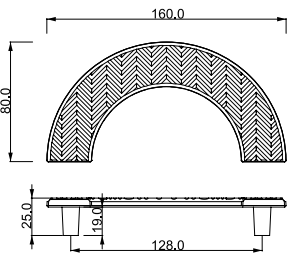
STANDARD FINISHES
STANDART RENKLERMP02
Chrome
KromPC24
Matt Black
Mat Siyah BoyaMP11
Gold
Altın RengiPC27
Matt Anthracite
Mat Antrasit BoyaMP30
Brushed Antique Brass
Fırçalanmış Antik PırnçPC35
Brushed Brass
Mat Sarı Boya

A 1197192
128
096
064
A 4197016



Material
Zinc Alloy

Materyal
Zamak

Kod	Uzunluk	Merkez	Genişlik	Yükseklik
Code	Length	Central	Width	Height
A1197192	224 mm	192 mm	112 mm	25 mm
A1197128	160 mm	128 mm	80 mm	25 mm
A1197096	160 mm	96 mm	80 mm	25 mm
A1197064	100 mm	64 mm	50 mm	26 mm
A4197016	60 mm	16 mm	60 mm	26 mm

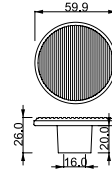
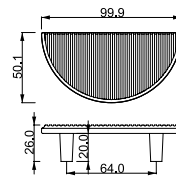
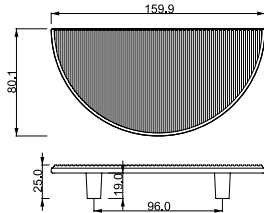
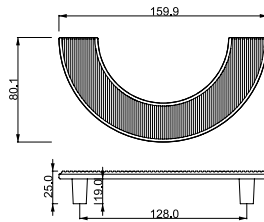
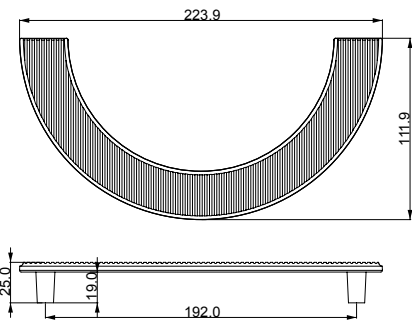

STANDARD FINISHES
STANDART RENKLER



MP02
Chrome
Krom



PC24
Matt Black
Mat Siyah Boya



MP11
Gold
Altın Rengi



PC27
Matt Anthracite
Mat Antrasit Boya



MP30
Brushed Antique Brass
Firçalanmış Antik Pirinç



PC35
Brushed Brass
Mat Sarı Boya

A 1196192
128
096
064
A 4196016

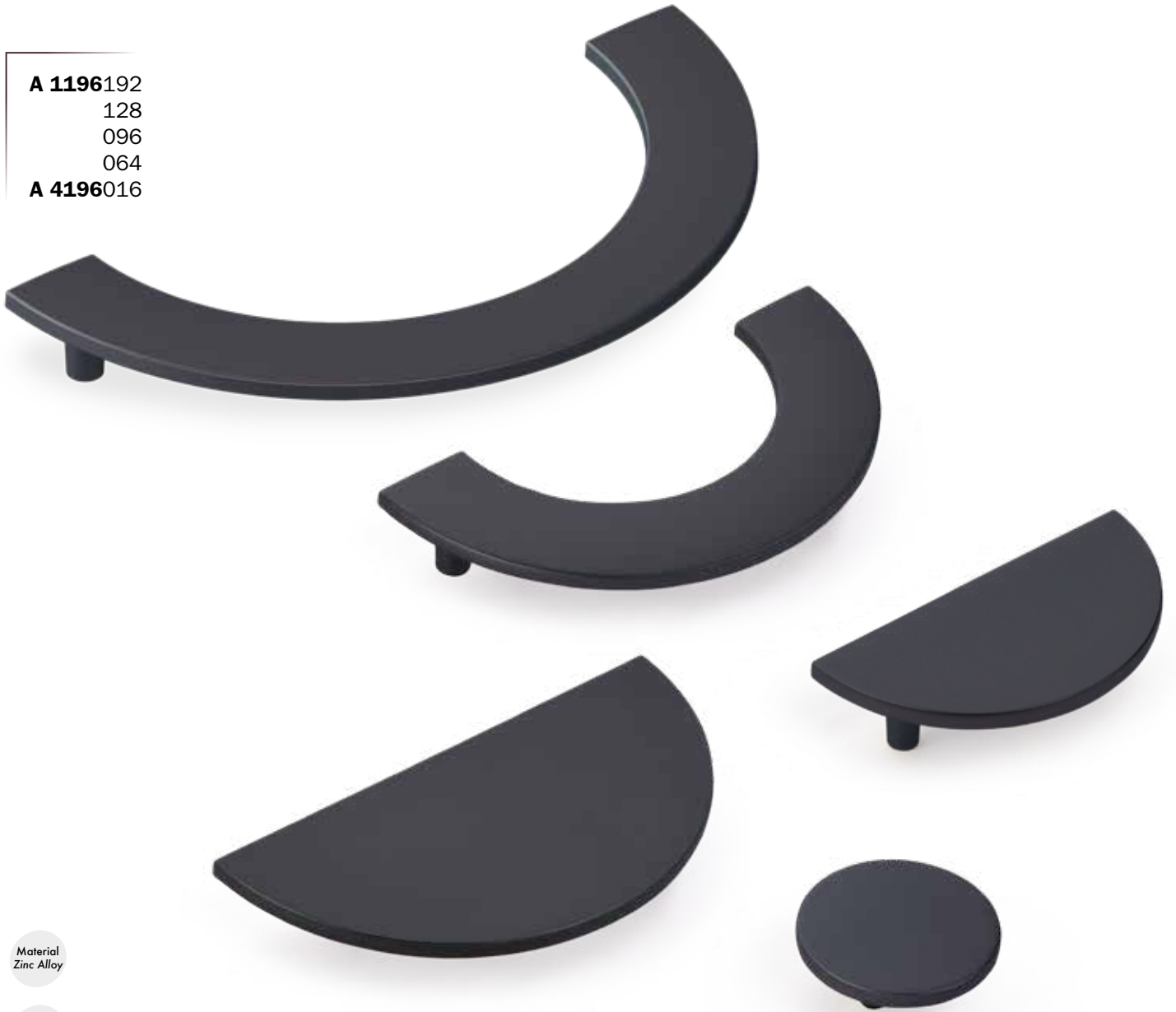

Material
Zinc Alloy

Materyal
Zamak

Kod	Uzunluk	Merkez	Genişlik	Yükseklik
Code	Length	Central	Width	Height
A1196192	224 mm	192 mm	112 mm	25 mm
A1196128	160 mm	128 mm	80 mm	25 mm
A1196096	160 mm	96 mm	80 mm	25 mm
A1196064	100 mm	64 mm	50 mm	26 mm
A4196016	60 mm	16 mm	60 mm	26 mm

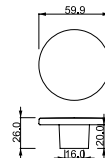
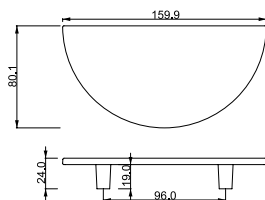
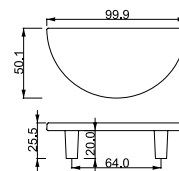
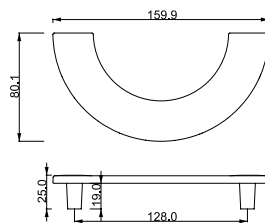
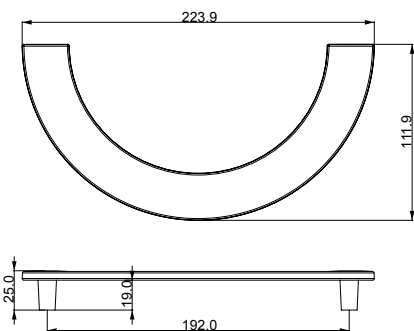

STANDARD FINISHES
STANDART RENKLER



A 1195128

096

064

A 4195016



Material
Zinc Alloy

Material
Zamak

Kod	Uzunluk	Merkez	Genişlik	Yükseklik
Code	Length	Central	Width	Height
A1195128	160 mm	128 mm	80 mm	25 mm
A1195096	160 mm	96 mm	80 mm	25 mm
A1195064	100 mm	64 mm	50 mm	26 mm
A4195016	60 mm	16 mm	60 mm	26 mm

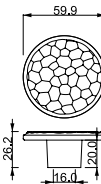
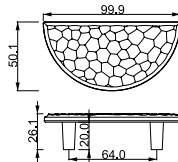
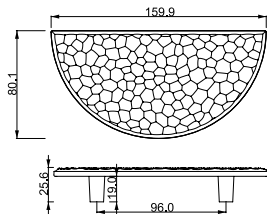
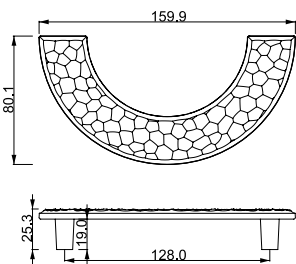

STANDARD FINISHES
STANDART RENKLER



MP02
Chrome
Krom



PC24
Matt Black
Mat Siyah Boya



MP11
Gold
Altın Rengi



PC27
Matt Anthracite
Mat Antrasit Boya



MP30
Brushed Antique Brass
Firçalanmış Antik Pirinç



PC35
Brushed Brass
Mat Sarı Boya

A 1194192
128
096
064
A 4194016

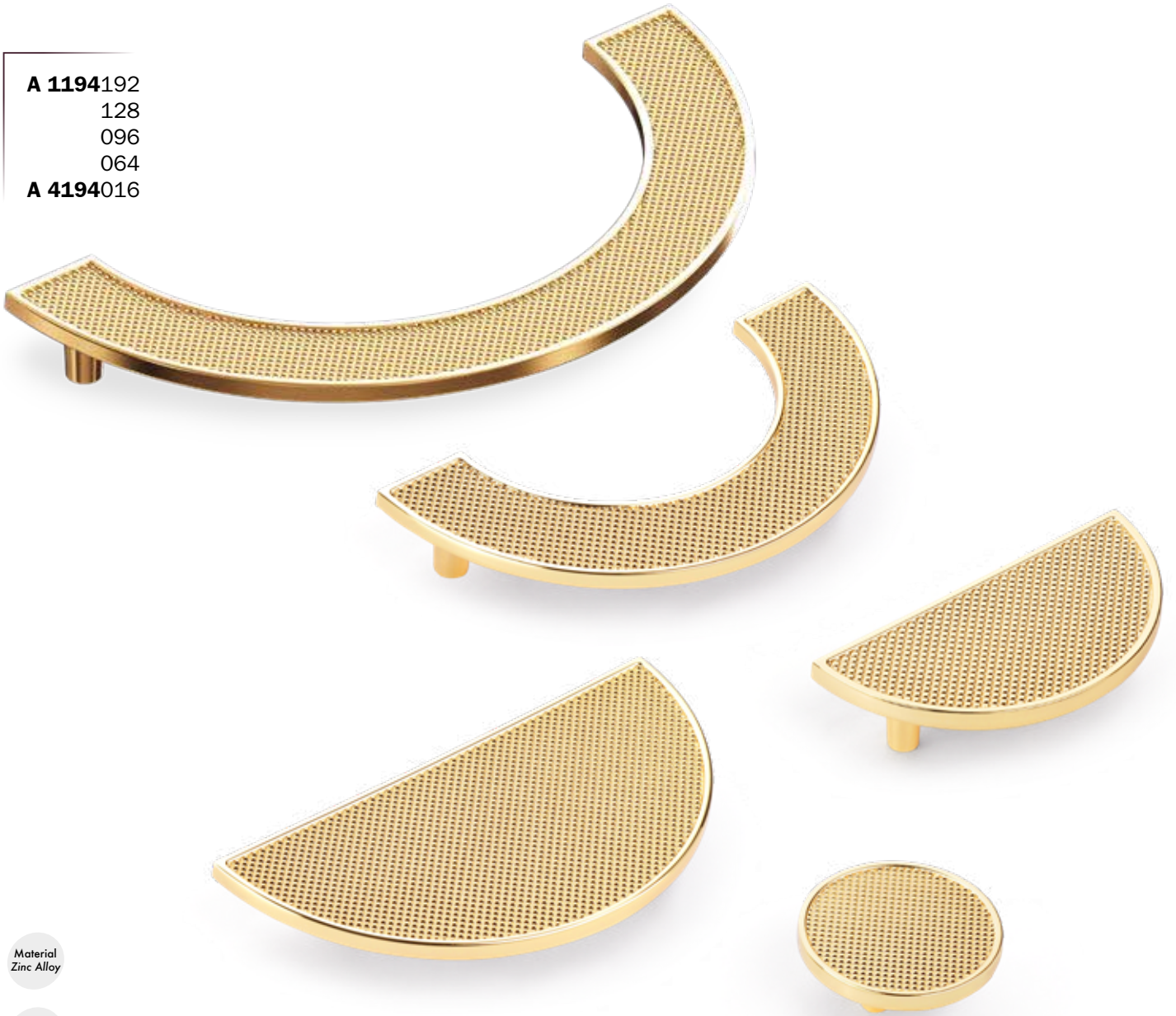

Material
Zinc Alloy

Materyal
Zamak

Kod	Uzunluk	Merkez	Genişlik	Yükseklik
Code	Length	Central	Width	Height
A1194192	224 mm	192 mm	112 mm	25 mm
A1194128	128 mm	128 mm	80 mm	25 mm
A1194096	160 mm	96 mm	80 mm	25 mm
A1194064	100 mm	64 mm	50 mm	26 mm
A4194016	60 mm	16 mm	60 mm	26 mm

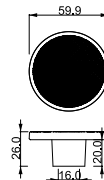
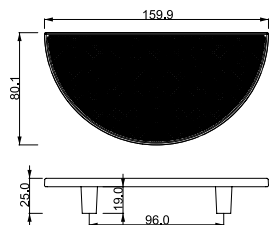
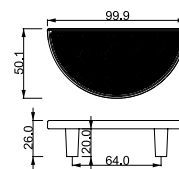
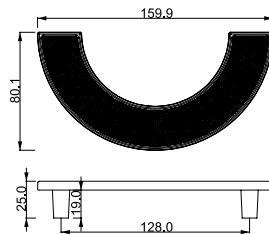
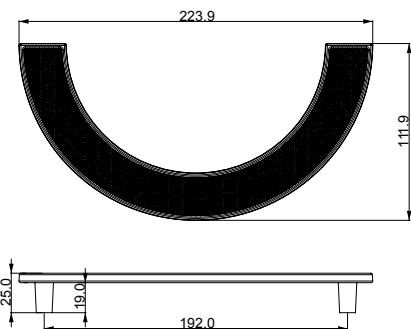

STANDARD FINISHES
STANDART RENKLER



MP02
Chrome
Krom



PC24
Matt Black
Mat Siyah Boya



MP11
Gold
Altın Rengi



PC27
Matt Anthracite
Mat Antrasit Boya



MP30
Brushed Antique Brass
Fırçalanmış Antik Pirinç



PC35
Brushed Brass
Mat Sarı Boya

A 1193128

096

064

A 4193016



Material
Zinc Alloy

Materyal
Zamak

Kod	Uzunluk	Merkez	Genişlik	Yükseklik
Code	Length	Central	Width	Height
A1193128	160 mm	128 mm	80 mm	25 mm
A1193096	160 mm	96 mm	80 mm	25 mm
A1193064	100 mm	64 mm	50 mm	26 mm
A4193016	60 mm	16 mm	60 mm	26 mm

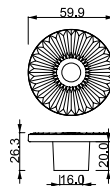
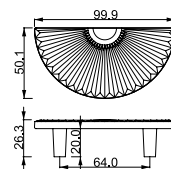
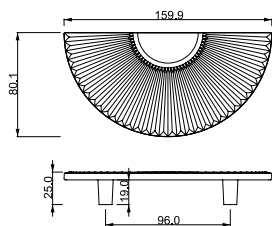
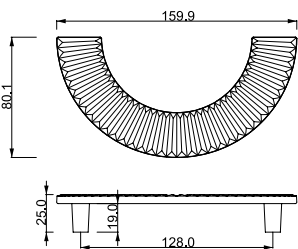

STANDARD FINISHES
STANDART RENKLER



MP02
Chrome
Krom



PC24
Matt Black
Mat Siyah Boya



MP11
Gold
Altın Rengi



PC27
Matt Anthracite
Mat Antrasit Boya



MP30
Brushed Antique Brass
Fırçalanmış Antik Pirinç



PC35
Brushed Brass
Mat Sarı Boya

A 1215224
128
064



Material
Zinc Alloy

Materyal
Zamak

Kod	Uzunluk	Merkez	Genişlik	Yükseklik
Code	Length	Central	Width	Height
A1215224	248 mm	224 mm	57 mm	33 mm
A1215128	160 mm	128 mm	80 mm	33 mm
A1215064	88 mm	64 mm	88 mm	33 mm

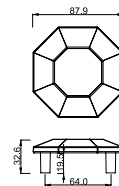
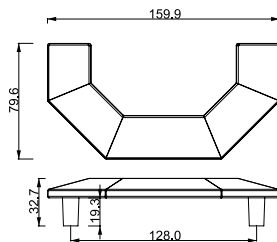
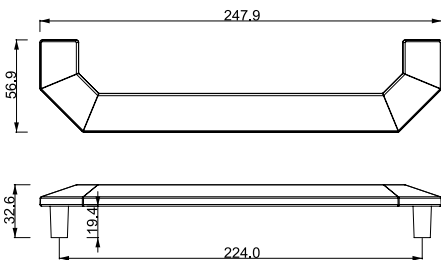

STANDARD FINISHES
STANDART RENKLER



MP02
Chrome
Krom



PC24
Matt Black
Mat Siyah Boya



MP11
Gold
Altın Rengi



PC27
Matt Anthracite
Mat Antrasit Boya



MP30
Brushed Antique Brass
Fırçalanmış Antik Pirinç



PC35
Brushed Brass
Mat Sarı Boya

A 1213224

128

064



Material
Zinc Alloy

Materyal
Zamak

Kod	Uzunluk	Merkez	Genişlik	Yükseklik
Code	Length	Central	Width	Height
A1213224	248 mm	224 mm	57 mm	33 mm
A1213128	160 mm	128 mm	80 mm	33 mm
A1213064	88 mm	64 mm	88 mm	33 mm

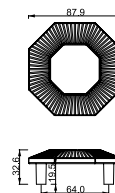
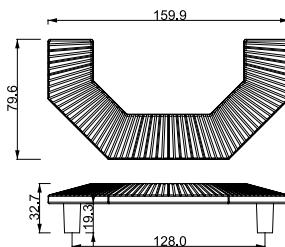
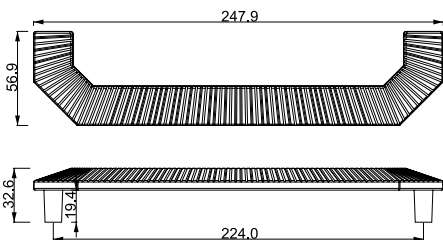

STANDARD FINISHES
STANDART RENKLER



MP02
Chrome
Krom



PC24
Matt Black
Mat Siyah Boya



MP11
Gold
Altın Rengi



PC27
Matt Anthracite
Mat Antrasit Boya



MP30
Brushed Antique Brass
Fırçalanmış Antik Pirinç



PC35
Brushed Brass
Mat Sarı Boya

A 1200224
A 4200032



Material
Zinc Alloy

Material
Zamak

Kod	Uzunluk	Merkez	Genişlik	Yükseklik
Code	Length	Central	Width	Height
A1200224	280 mm	224 mm	28 mm	26 mm
A4200032	99 mm	32 mm	46 mm	26 mm

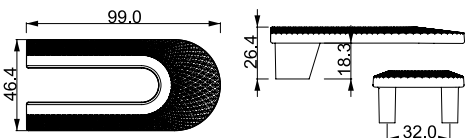
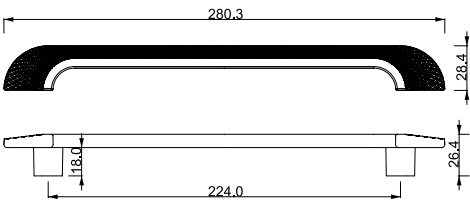

STANDARD FINISHES
STANDART RENKLER



MP02
Chrome
Krom



PC24
Matt Black
Mat Siyah Boya



MP11
Gold
Altın Rengi



PC27
Matt Anthracite
Mat Antrasit Boya



MP30
Brushed Antique Brass
Firçalanmış Antik Pırnç



PC35
Brushed Brass
Mat Sarı Boya

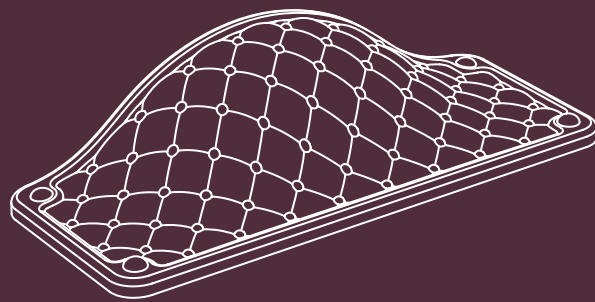

GROVE FURNITURE
HANDLES
TAS KULPLAR

Discover new passions



A 1180160

Material
Zinc AlloyMateryal
Zamak

Kod	Uzunluk	Merkez	Genişlik	Yükseklik
Code	Length	Central	Width	Height
A1180160	170 mm	160 mm	36 mm	21 mm

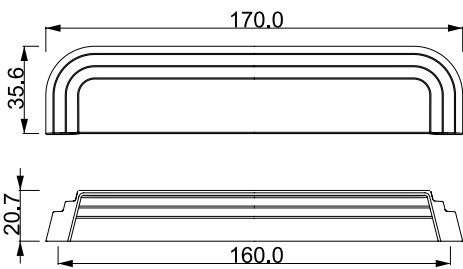
STANDARD FINISHES
STANDART RENKLERMP10
Antique Bronze
Antik BronzPC24
Matt Black
Mat Siyah BoyaPC27
Matt Anthracite
Mat Antrasit BoyaPC35
Brushed Brass
Mat Sarı Boya

A 344064



A 344032



Material
Zinc Alloy

Material
Zamak

Kod	Uzunluk	Merkez	Genişlik	Yükseklik
Code	Length	Central	Width	Height
A344064	94 mm	64 mm	38 mm	17 mm
A344032	78 mm	32 mm	31 mm	16 mm

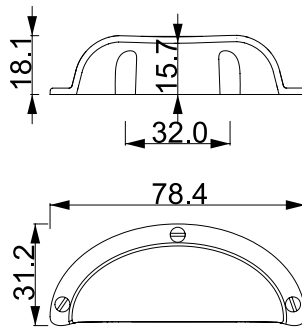
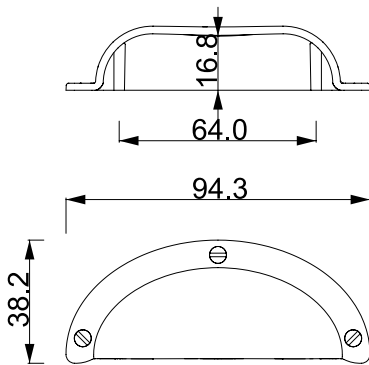

STANDARD FINISHES
STANDART RENKLER



A 4179032

Material
Zinc AlloyMaterial
Zamak

Kod	Uzunluk	Merkez	Genişlik	Yükseklik
Code	Length	Central	Width	Height
A4179032	100 mm	32 mm	41 mm	23 mm

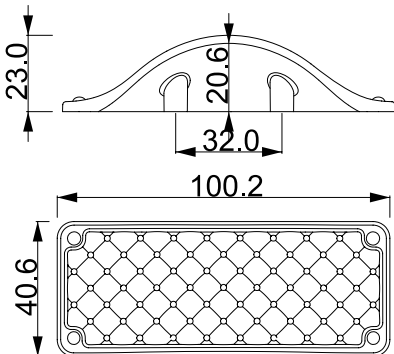
STANDARD FINISHES
STANDART RENKLERMP02
Chrome
KromPC24
Matt Black
Mat Siyah BoyaMP10
Anthique Bronze
Antik BronzPC27
Matt Anthracite
Mat Antrasit BoyaPC35
Brushed Brass
Mat Sarı Boya

A 4178032

Material
Zinc AlloyMaterial
Zamak

Kod	Uzunluk	Merkez	Genişlik	Yükseklik
Code	Length	Central	Width	Height
A4178032	100 mm	32 mm	41 mm	23 mm

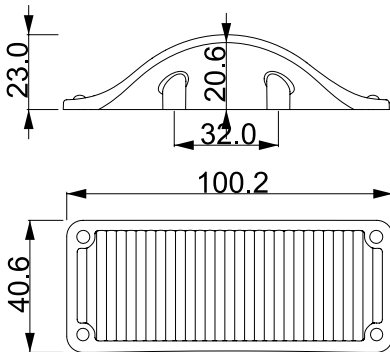
STANDARD FINISHES
STANDART RENKLERMP02
Chrome
KromPC24
Matt Black
Mat Siyah BoyaMP10
Antique Bronze
Antik BronzPC27
Matt Anthracite
Mat Antrasit BoyaMP14
Antique Silver
Antik GümüşPC35
Brushed Brass
Mat Sarı Boya

A 1177064



A 4177032

Material
Zinc AlloyMateryal
Zamak

Kod	Uzunluk	Merkez	Genişlik	Yükseklik
Code	Length	Central	Width	Height
A1177064	100 mm	64 mm	40 mm	22 mm
A4177032	80 mm	32 mm	35 mm	22 mm

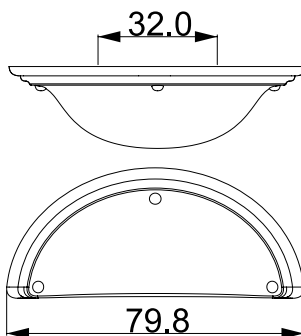
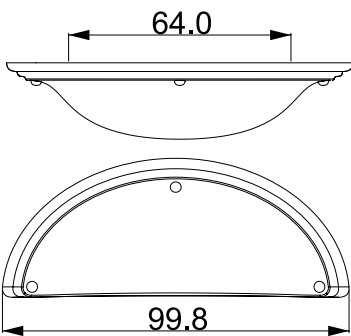
STANDARD FINISHES
STANDART RENKLERMP10
Antique Bronze
Antik BronzPC24
Matt Black
Mat Siyah BoyaPC27
Matt Anthracite
Mat Antrasit BoyaPC35
Brushed Brass
Mat Sarı Boya

A 1172064



A 4172032

Material
Zinc AlloyMateryal
Zamak

Kod	Uzunluk	Merkez	Genişlik	Yükseklik
Code	Length	Central	Width	Height
A1172064	132 mm	64 mm	40 mm	22 mm
A4172032	100 mm	32 mm	40 mm	22 mm

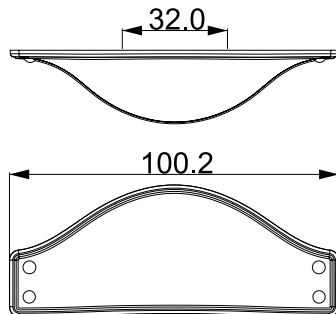
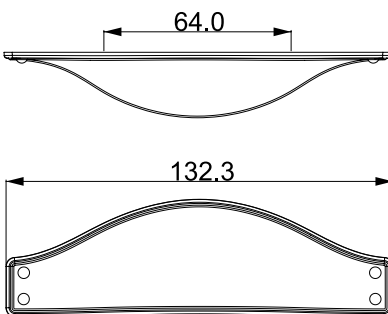
STANDARD FINISHES
STANDART RENKLERMP10
Antique Bronze
Antik BronzPC24
Matt Black
Mat Siyah BoyaPC27
Matt Anthracite
Mat Antrasit BoyaPC35
Brushed Brass
Mat Sarı Boya

A 1170096



A 1170064

Material
Zinc AlloyMateryal
Zamak

Kod	Uzunluk	Merkez	Genişlik	Yükseklik
Code	Length	Central	Width	Height
A1170096	134 mm	96 mm	35 mm	22 mm
A1170064	102 mm	64 mm	35 mm	22 mm

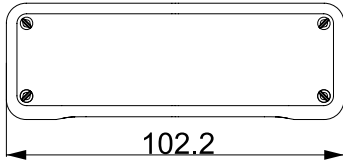
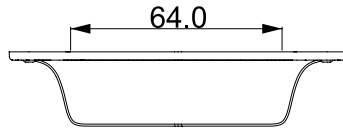
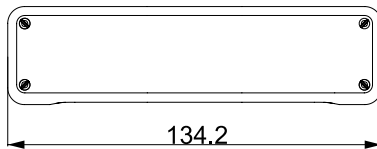
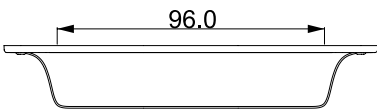
STANDARD FINISHES
STANDART RENKLERMP10
Antique Bronze
Antik BronzPC24
Matt Black
Mat Siyah BoyaMP11
Gold
Altın RengiPC27
Matt Anthracite
Mat Antrasit BoyaPC35
Brushed Brass
Mat Sarı Boya

A 1168096



A 1168064

Material
Zinc AlloyMaterial
Zamak

Kod	Uzunluk	Merkez	Genişlik	Yükseklik
Code	Length	Central	Width	Height
A1168096	142 mm	96 mm	40 mm	22 mm
A1168064	110 mm	64 mm	40 mm	22 mm

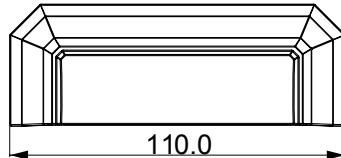
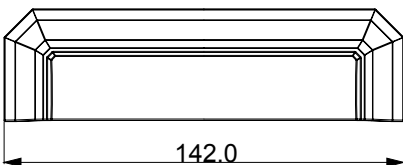
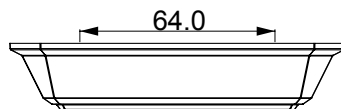
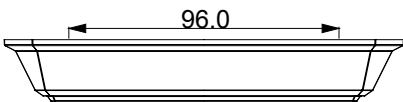
STANDARD FINISHES
STANDART RENKLERMP10
Antique Bronze
Antik BronzPC24
Matt Black
Mat Siyah BoyaPC27
Matt Anthracite
Mat Antrasit BoyaPC35
Brushed Brass
Mat Sarı Boya

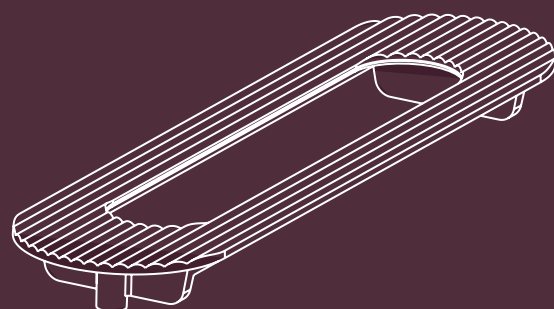

FLUSH HANDLES GÖMME KULPLAR

Discover new passions

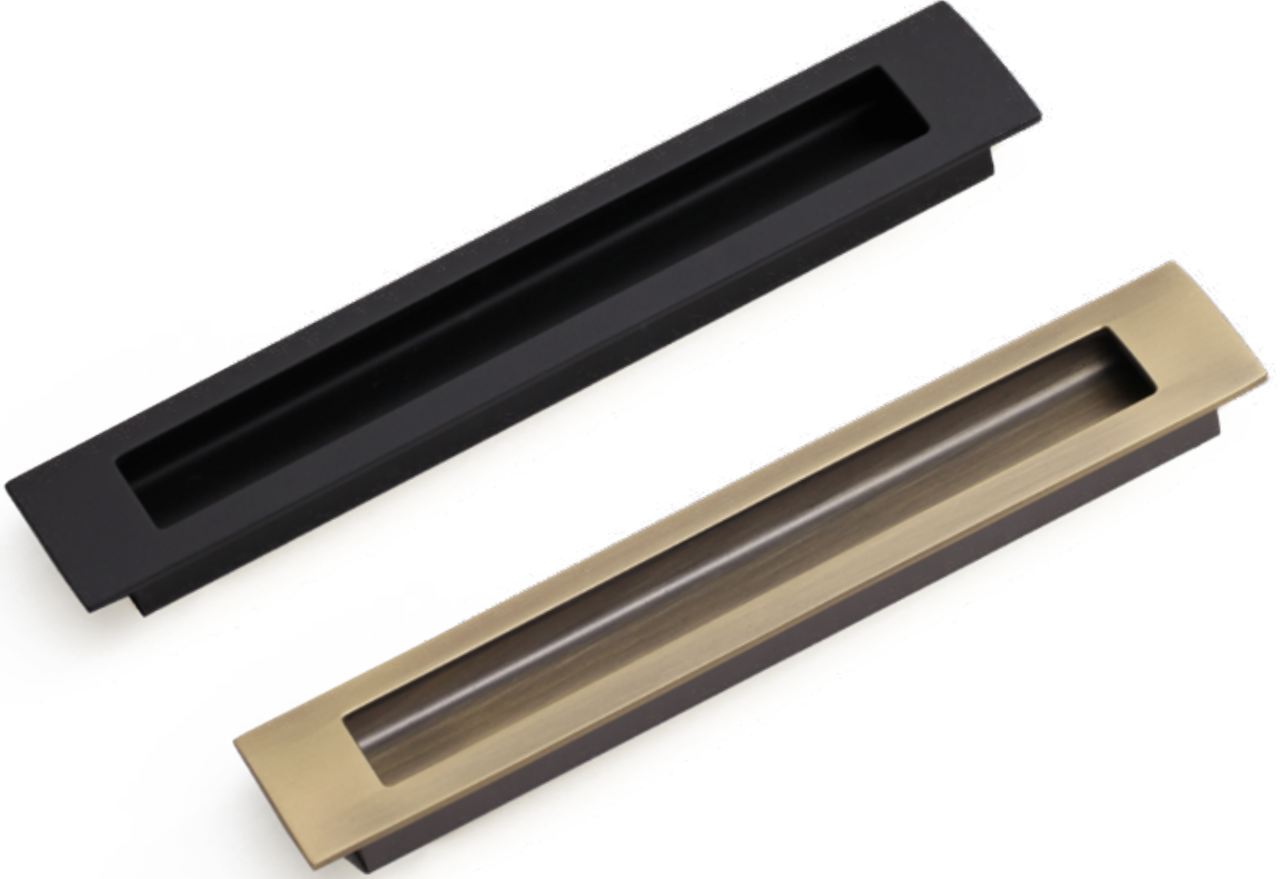

A 1229160

Material
Zinc AlloyMateryal
Zamak

Kod	Uzunluk	Merkez	Genişlik	Yükseklik
Code	Length	Central	Width	Height
A1229160	179 mm	160 mm	33 mm	14,5 mm

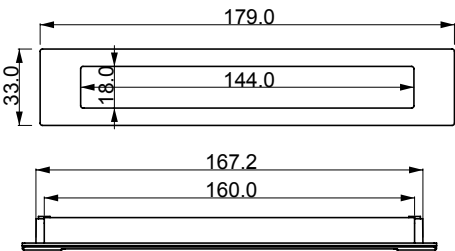
STANDARD FINISHES
STANDART RENKLERMP02
Chrome
KromPC24
Matt Black
Mat Siyah BoyaMP08
Bright Brushed Inox
Nikel SatinePC27
Matt Anthracite
Mat Antrasit BoyaMP30
Brushed Antique Brass
Fırçalanmış Antik PirinçPC35
Brushed Brass
Mat Sarı Boya

A 1181160

Material
Zinc AlloyMaterial
Zamak

Kod	Uzunluk	Merkez	Genişlik	Yükseklik
Code	Length	Central	Width	Height
A1181160	200 mm	160 mm	52 mm	18 mm

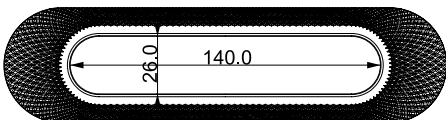
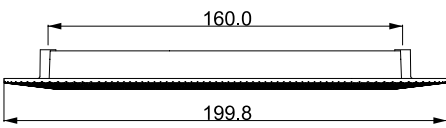
STANDARD FINISHES
STANDART RENKLERMP02
Chrome
KromPC24
Matt Black
Mat Siyah BoyaMP11
Gold
Altın RengiPC27
Matt Anthracite
Mat Antrasit BoyaMP30
Brushed Antique Brass
Fırçalanmış Antik PirinçPC35
Brushed Brass
Mat Sarı Boya

A 1174160

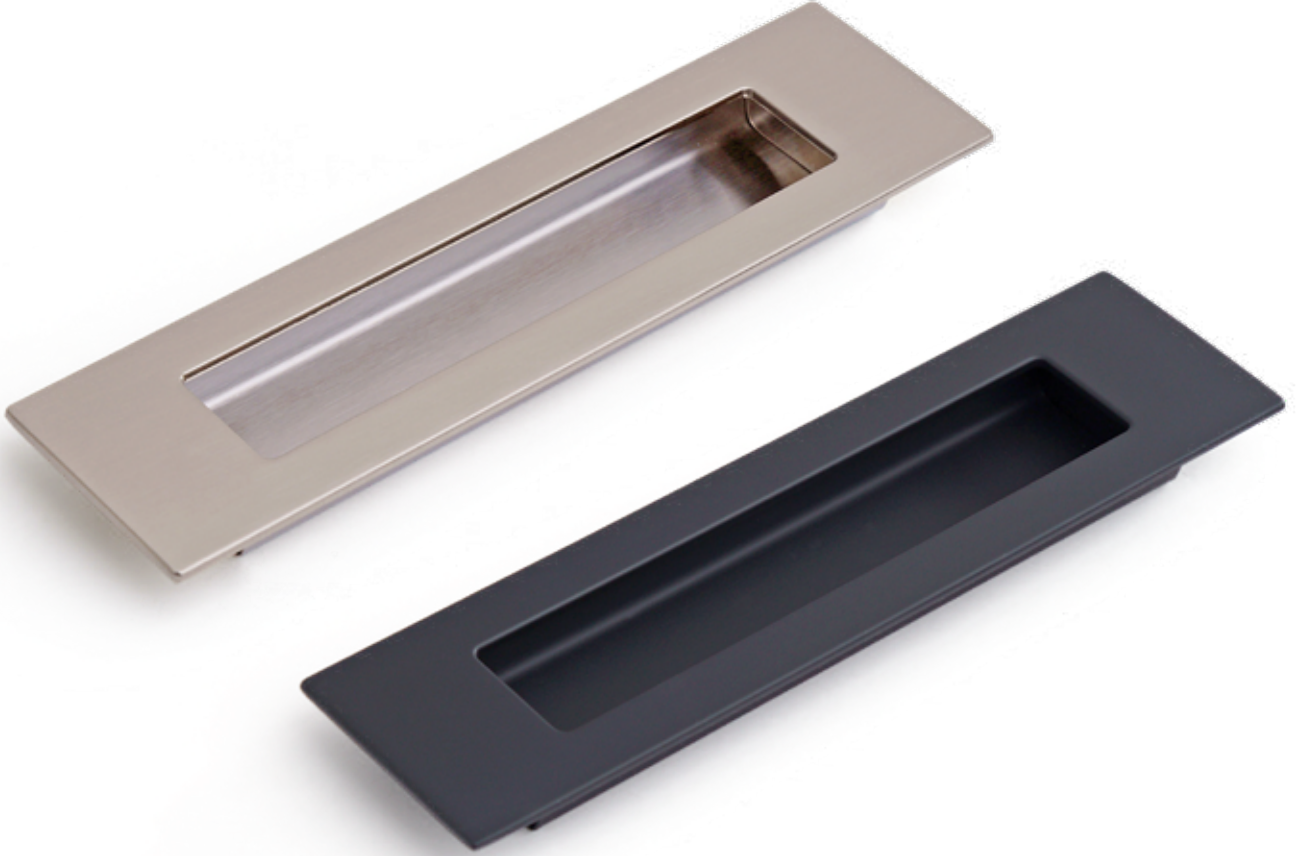
Material
Zinc AlloyMateryal
Zamak

Kod	Uzunluk	Merkez	Genişlik	Yükseklik
Code	Length	Central	Width	Height
A1174160	200 mm	160 mm	52 mm	17 mm

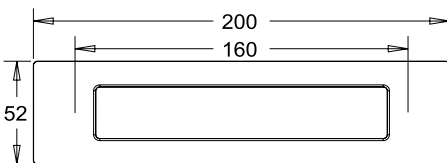
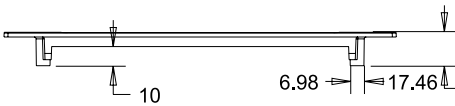
STANDARD FINISHES
STANDART RENKLERMP02
Chrome
KromPC24
Matt Black
Mat Siyah BoyaMP08
Bright Brushed Inox
Nikel SatinePC27
Matt Anthracite
Mat Antrasit BoyaMP30
Brushed Antique Brass
Fırçalanmış Antik PirinçPC35
Brushed Brass
Mat Sarı Boya

A 1173160

Material
Zinc AlloyMateryal
Zamak

Kod	Uzunluk	Merkez	Genişlik	Yükseklik
Code	Length	Central	Width	Height
A1173160	200 mm	160 mm	52 mm	17 mm

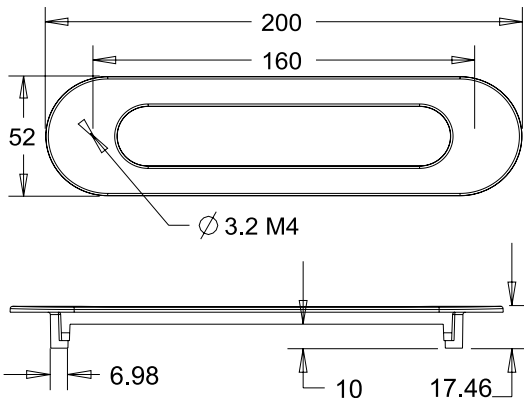
STANDARD FINISHES
STANDART RENKLERMP02
Chrome
KromPC24
Matt Black
Mat Siyah BoyaMP08
Bright Brushed Inox
Nikel SatinePC27
Matt Anthracite
Mat Antrasit BoyaMP30
Brushed Antique Brass
Firçalanmış Antik PirinçPC35
Brushed Brass
Mat Sarı Boya

A 1106128

Material
Zinc AlloyMaterial
Zamak

Kod	Uzunluk	Merkez	Genişlik	Yükseklik
Kod	Uzunluk	Merkez	Genişlik	Yükseklik
A1106128	144 mm	128 mm	52 mm	17 mm

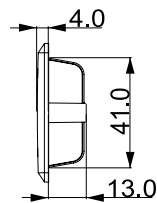
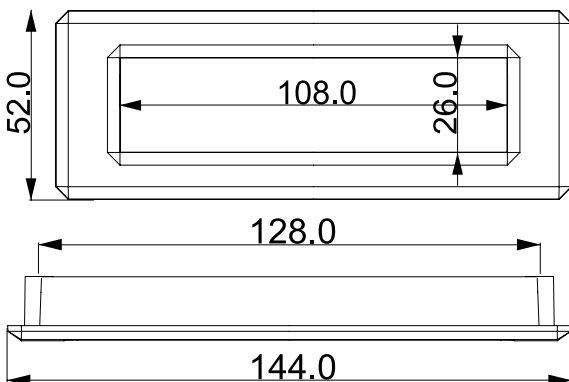
STANDARD FINISHES
STANDART RENKLERMP02
Chrome
KromPC24
Matt Black
Mat Siyah BoyaMP08
Bright Brushed Inox
Nikel SatinePC27
Matt Anthracite
Mat Antrasit BoyaMP11
Gold
Altın RengiPC35
Brushed Brass
Mat Sarı Boya

A 1101128

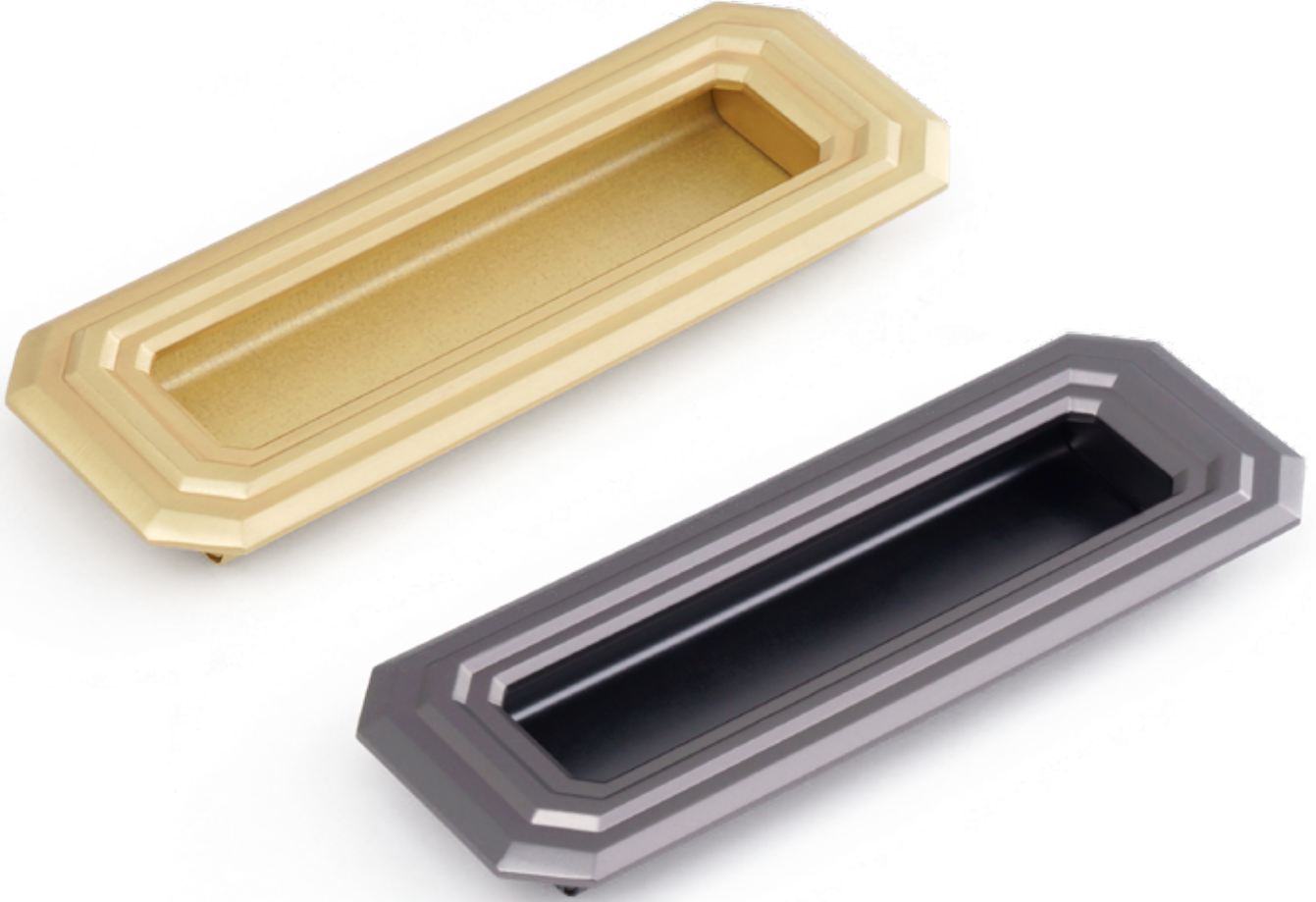
Material
Zinc AlloyMateriyal
Zamak

Kod	Uzunluk	Merkez	Genişlik	Yükseklik
Kod	Uzunluk	Merkez	Genişlik	Yükseklik
A1101128	154 mm	128 mm	54 mm	18 mm

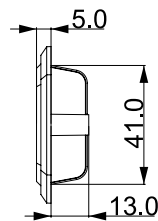
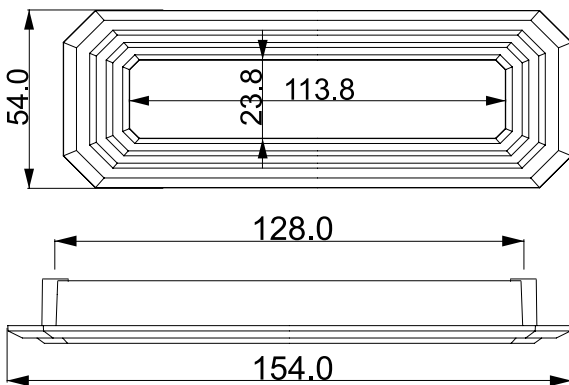
STANDARD FINISHES
STANDART RENKLERMP02
Chrome
KromMP30
Brushed Antique Brass
Fırçalanmış Antik PirinçPC24
Matt Black
Mat Siyah BoyaMP11
Gold
Altın RengiPC27
Matt Anthracite
Mat Antrasit BoyaMP14
Antique Silver
Antik GümüşPC35
Brushed Brass
Mat Sarı Boya

A 200160

Material
Zinc AlloyMateryal
Zamak

Kod	Uzunluk	Merkez	Genişlik	Yükseklik
Code	Length	Central	Width	Height
A200160	172 mm	160 mm	48 mm	15 mm

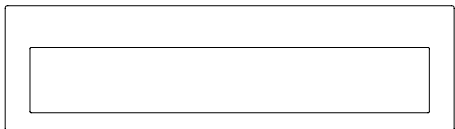
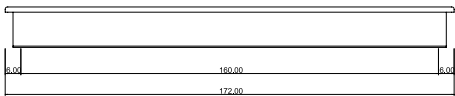
STANDARD FINISHES
STANDART RENKLERMP02
Chrome
KromPC24
Matt Black
Mat Siyah BoyaPC35
Brushed Brass
Mat Sarı BoyaMP08
Bright Brushed Inox
Nikel SatinePC27
Matt Anthracite
Mat Antrasit BoyaPC36
Metallic Brown
Metalik KahvePC29
Metallic Bronze
Metalik Bronz

A 193128

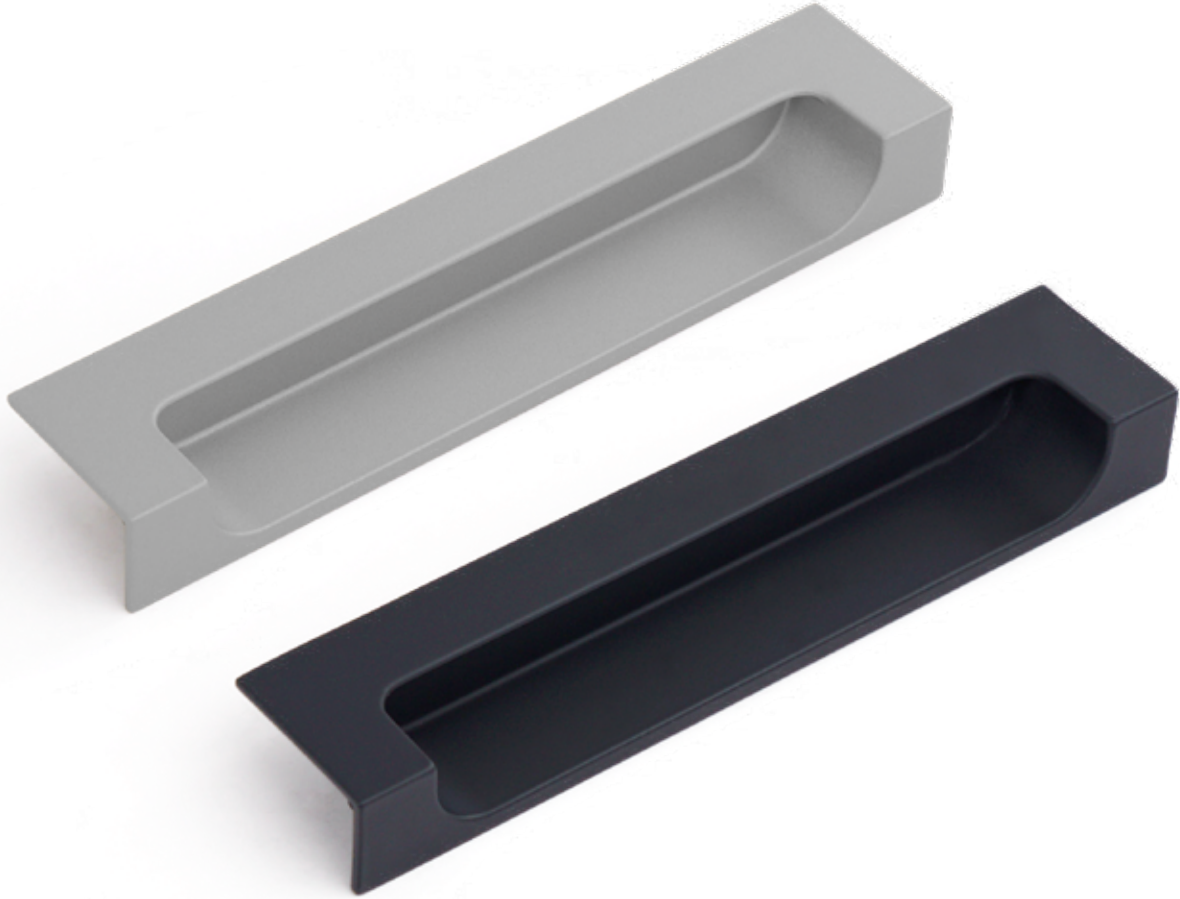
Material
Zinc AlloyMateriyal
Zamak

Kod	Uzunluk	Merkez	Genişlik	Yükseklik
Code	Length	Central	Width	Height
A193128	150 mm	128 mm	30 mm	18 mm

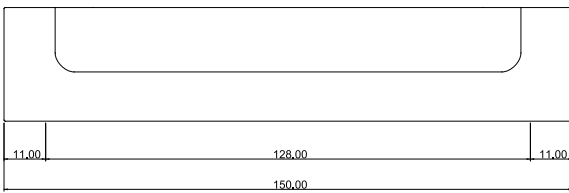
STANDARD FINISHES
STANDART RENKLERPC05
Matt Chrome
Mat Krom BoyaPC24
Matt Black
Mat Siyah BoyaPC27
Matt Anthracite
Mat Antrasit BoyaPC35
Brushed Brass
Mat Sarı Boya

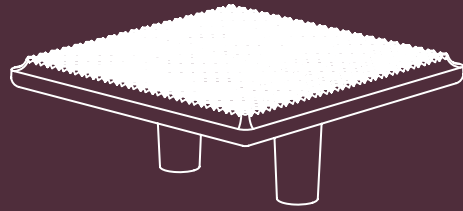
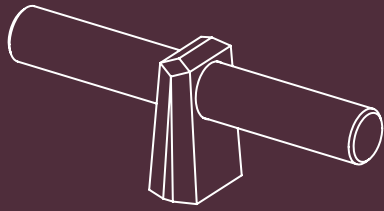

MODERN FURNITURE KNOBS MODERN MOBİLYA DÜĞMELERİ

Discover new passions



A 4281016



A 4280016



A 4279016



Material
Zinc Alloy

Material
Zamak

A1281320	347 mm	320 mm	9 mm	33 mm
A1281160	187 mm	160 mm	9 mm	33 mm
A4281016	34 mm	16 mm	34 mm	28 mm

Kod	Uzunluk	Merkez	Genişlik	Yükseklik	Renk
Code	Length	Central	Width	Height	Colour
A4281016	34 mm	16 mm	34 mm	28 mm	PC24/PC27/PC35
A4280016	35 mm	16 mm	35 mm	33 mm	PC24/PC27/PC35
A4279016	60 mm	16 mm	24 mm	39 mm	MP02/MP11/MP30/PC24/PC27/PC35

STANDARD FINISHES
STANDART RENKLER



MP02
Chrome
Krom



PC24
Matt Black
Mat Siyah Boya



MP11
Gold
Altın Rengi



PC27
Matt Anthracite
Mat Antrasit Boya



MP30
Brushed Antique Brass
Fırçalanmış Antik Pirinç



PC35
Brushed Brass
Mat Sarı Boya

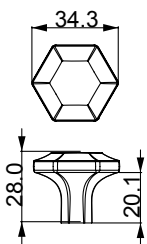

A 4281016

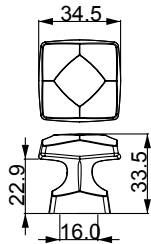

A 4280016

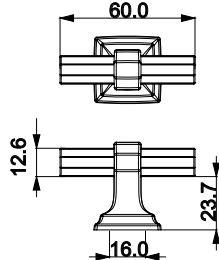

A 4279016

A 4278016



A 4275016



A 4274016



Material
Zinc Alloy

Materyal
Zamak

Kod	Uzunluk	Merkez	Genişlik	Yükseklik	Renk
Code	Length	Central	Width	Height	Colour
A4278016	34 mm	16 mm	34 mm	28 mm	MP02/ MP08/MP11/MP30/PC24/PC27/PC35
A4275016	64 mm	16 mm	16 mm	26 mm	MP02/MP11/MP30/PC24/PC27/PC35
A4274016	64 mm	16 mm	16 mm	26 mm	MP02/MP11/MP30/PC24/PC27/PC35

STANDARD FINISHES
STANDART RENKLER



MP02
Chrome
Krom



PC24
Matt Black
Mat Siyah Boya



MP11
Gold
Altın Rengi



PC27
Matt Anthracite
Mat Antrasit Boya



MP30
Brushed Antique Brass
Fırçalanmış Antik Pirinç



PC35
Brushed Brass
Mat Sarı Boya

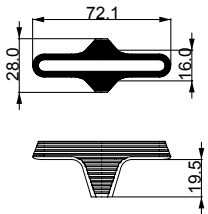

A 4278016

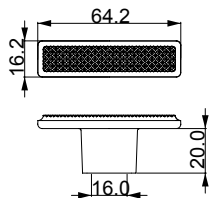

A 4275016

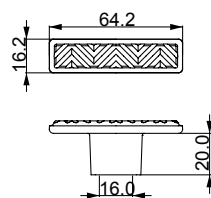

A 4274016

A 4273016



A 4272016

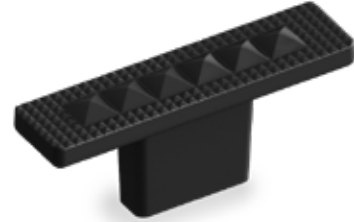

4271016



4270016



Material
Zinc Alloy

Material
Zamak

Kod	Uzunluk	Merkez	Genişlik	Yükseklik	Renk
Code	Length	Central	Width	Height	Colour
A4273016	64 mm	16 mm	16 mm	26 mm	MP02/MP11/MP30/PC24/MP27/PC35
A4272016	64 mm	16 mm	16 mm	27 mm	MP02/MP11/MP30/PC24/MP27/PC35
A4271016	64 mm	16 mm	16 mm	26 mm	MP02/MP11/MP30/PC24/MP27/PC35
A4270016	64 mm	16 mm	16 mm	26 mm	MP02/MP11/MP30/PC24/MP27/PC35

STANDARD FINISHES
STANDART RENKLER



MP02
Chrome
Krom



PC24
Matt Black
Mat Siyah Boya



MP11
Gold
Altın Rengi



PC27
Matt Anthracite
Mat Antrasit Boya



MP30
Brushed Antique Brass
Firçalanmış Antik Pırnç



PC35
Brushed Brass
Mat Sarı Boya

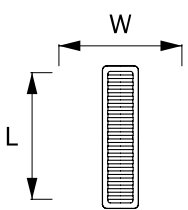

A 4273016

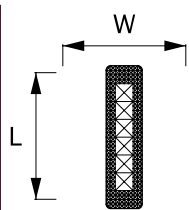

A 4272016

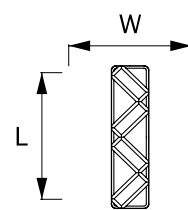

A 4271016

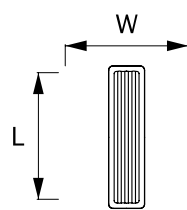

A 4270016

A 424130016

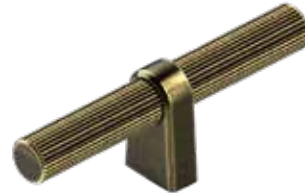

A 424120016



A 424110016

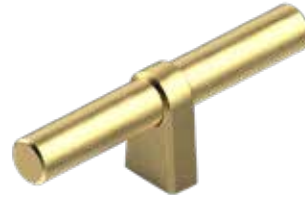

Material
Zinc Alloy
AL

Material
Zağnak
&
Alüminyum

Kod	Uzunluk	Merkez	Genişlik	Yükseklik
Code	Length	Central	Width	Height
A424130016	116 mm	16 mm	16 mm	40 mm
A424120016	116 mm	16 mm	16 mm	40 mm
A424110016	116 mm	16 mm	16 mm	40 mm

STANDARD FINISHES
STANDART RENKLER



MP30
Brushed Antique Brass
Fırçalanmış Antik Pirinç



PC24
Matt Black
Mat Siyah Boya



PC27
Matt Anthracite
Mat Antrasit Boya



PC35
Brushed Brass
Mat Sarı Boya

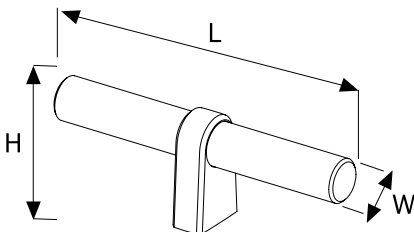

A 424230016



A 424010016

Material
Zinc Alloy
ZnMaterial
Zağnak
&
Alüminyum

Kod	Uzunluk	Merkez	Genişlik	Yükseklik
Code	Length	Central	Width	Height
A424230016	116 mm	16 mm	16 mm	38 mm
A424010016	116 mm	16 mm	16 mm	38 mm

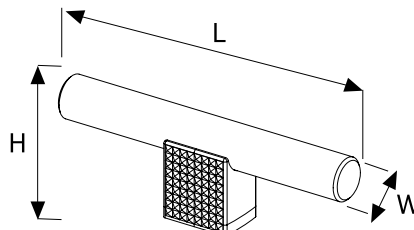
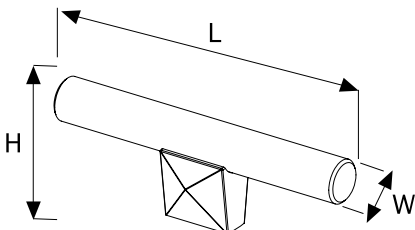
STANDARD FINISHES
STANDART RENKLERMP30
Brushed Antique Brass
Fırçalanmış Antik PirinçPC24
Matt Black
Mat Siyah BoyaPC27
Matt Anthracite
Mat Antrasit BoyaPC35
Brushed Brass
Mat Sarı Boya

A 4236002



A 4236001

Material
Zinc AlloyMateriyal
Zamak

Kod	Uzunluk	Merkez	Genişlik	Yükseklik
Code	Length	Central	Width	Height
A4236002	40 mm	-	40 mm	29 mm
A4236001	30 mm	-	30 mm	28 mm

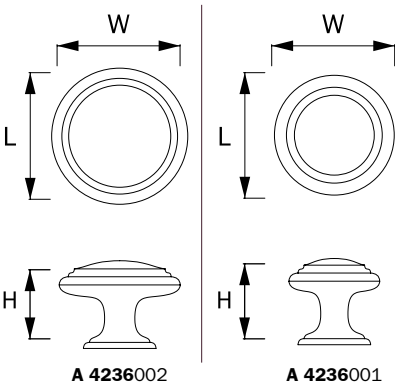
STANDARD FINISHES
STANDART RENKLER

A 4207032

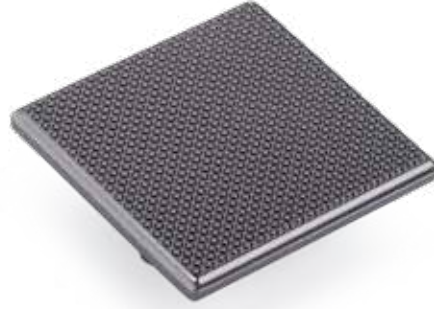
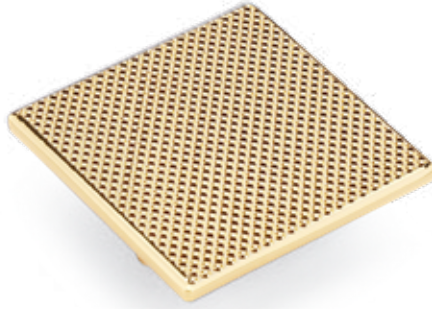
Material
Zinc AlloyMateryal
Zamak

Kod	Uzunluk	Merkez	Genişlik	Yükseklik
Code	Length	Central	Width	Height
A4207032	64 mm	32 mm	64 mm	26 mm

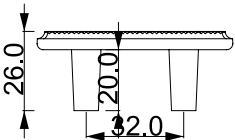
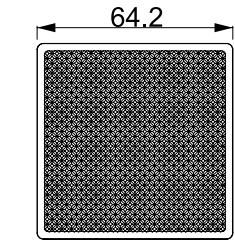
STANDARD FINISHES
STANDART RENKLERMP02
Chrome
KromPC24
Matt Black
Mat Siyah BoyaMP11
Gold
Altın RengiPC27
Matt Anthracite
Mat Antrasit BoyaMP30
Brushed Antique Brass
Fırçalanmış Antik PirinçPC35
Brushed Brass
Mat Sarı Boya

A 4206032

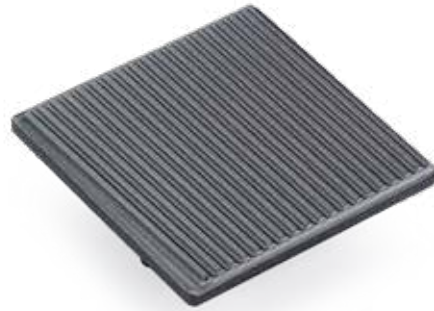
Material
Zinc AlloyMateryal
Zamak

Kod	Uzunluk	Merkez	Genişlik	Yükseklik
Code	Length	Central	Width	Height
A4206032	64 mm	32 mm	64 mm	26 mm

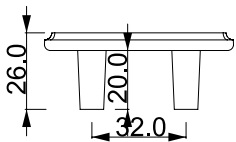
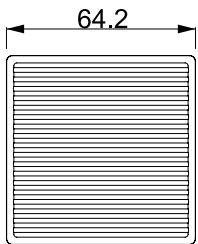
STANDARD FINISHES
STANDART RENKLERMP02
Chrome
KromPC24
Matt Black
Mat Siyah BoyaMP11
Gold
Altın RengiPC27
Matt Anthracite
Mat Antrasit BoyaMP30
Brushed Antique Brass
Fırçalanmış Antik PirinçPC35
Brushed Brass
Mat Sarı Boya

A 4205032

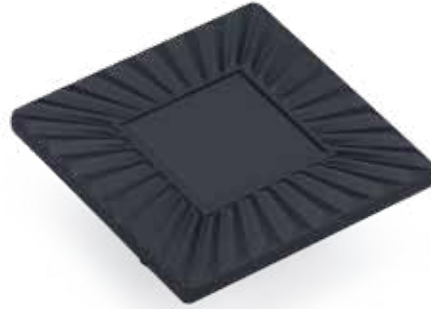
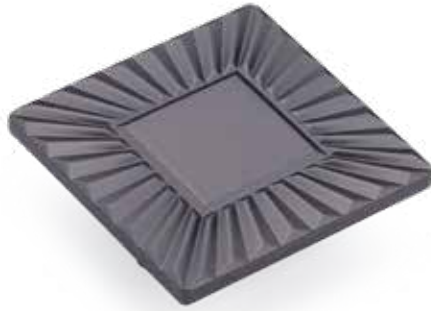
Material
Zinc AlloyMateryal
Zamak

Kod	Uzunluk	Merkez	Genişlik	Yükseklik
Code	Length	Central	Width	Height
A4205032	64 mm	32 mm	64 mm	26 mm

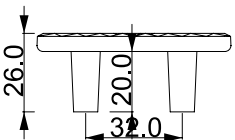
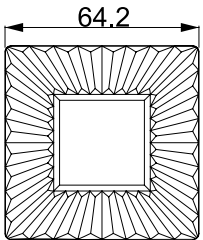
STANDARD FINISHES
STANDART RENKLERMP02
Chrome
KromPC24
Matt Black
Mat Siyah BoyaMP11
Gold
Altın RengiPC27
Matt Anthracite
Mat Antrasit BoyaMP30
Brushed Antique Brass
Fırçalanmış Antik PirinçPC35
Brushed Brass
Mat Sarı Boya

A 4204032

Material
Zinc AlloyMateryal
Zamak

Kod	Uzunluk	Merkez	Genişlik	Yükseklik
Code	Length	Central	Width	Height
A4204032	64 mm	32 mm	64 mm	26 mm

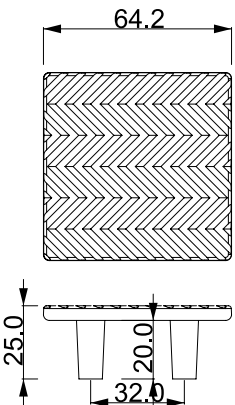
STANDARD FINISHES
STANDART RENKLERMP02
Chrome
KromPC24
Matt Black
Mat Siyah BoyaMP11
Gold
Altın RengiPC27
Matt Anthracite
Mat Antrasit BoyaMP30
Brushed Antique Brass
Fırçalanmış Antik PirinçPC35
Brushed Brass
Mat Sarı Boya

A 4203032

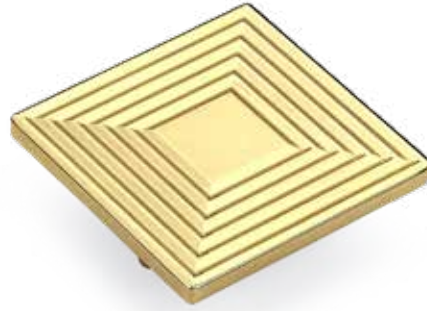
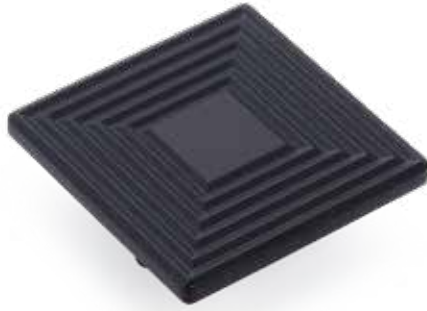
Material
Zinc AlloyMateryal
Zamak

Kod	Uzunluk	Merkez	Genişlik	Yükseklik
Code	Length	Central	Width	Height
A4203032	64 mm	32 mm	64 mm	26 mm

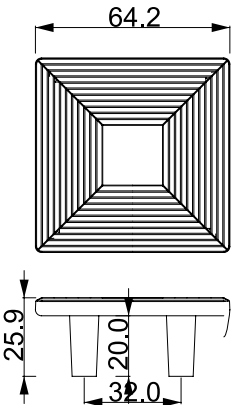
STANDARD FINISHES
STANDART RENKLERMP02
Chrome
KromPC24
Matt Black
Mat Siyah BoyaMP11
Gold
Altın RengiPC27
Matt Anthracite
Mat Antrasit BoyaMP30
Brushed Antique Brass
Fırçalanmış Antik PirinçPC35
Brushed Brass
Mat Sarı Boya

A 4202032

Material
Zinc AlloyMateriyal
Zamak

Kod	Uzunluk	Merkez	Genişlik	Yükseklik
Code	Length	Central	Width	Height
A4202032	64 mm	32 mm	64 mm	26 mm

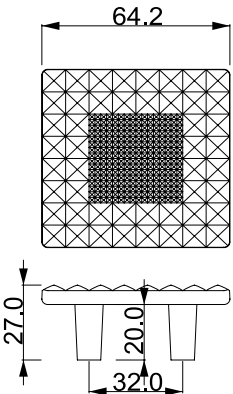
STANDARD FINISHES
STANDART RENKLERMP02
Chrome
KromPC24
Matt Black
Mat Siyah BoyaMP11
Gold
Altın RengiPC27
Matt Anthracite
Mat Antrasit BoyaMP30
Brushed Antique Brass
Fırçalanmış Antik PirinçPC35
Brushed Brass
Mat Sarı Boya

A 4201032

Material
Zinc AlloyMaterial
Zamak

Kod	Uzunluk	Merkez	Genişlik	Yükseklik
Code	Length	Central	Width	Height
A4201032	64 mm	32 mm	64 mm	26 mm

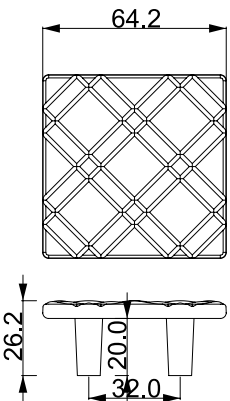
STANDARD FINISHES
STANDART RENKLERMP02
Chrome
KromPC24
Matt Black
Mat Siyah BoyaMP11
Gold
Altın RengiPC27
Matt Anthracite
Mat Antrasit BoyaMP30
Brushed Antique Brass
Fırçalanmış Antik PirinçPC35
Brushed Brass
Mat Sarı Boya

A 4200032

Material
Zinc AlloyMateriyal
Zamak

Kod	Uzunluk	Merkez	Genişlik	Yükseklik
Code	Length	Central	Width	Height
A4200032	99 mm	32 mm	46 mm	26 mm

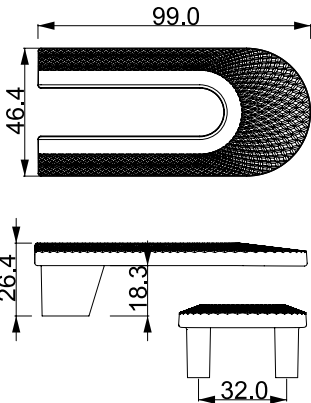
STANDARD FINISHES
STANDART RENKLERMP02
Chrome
KromPC24
Matt Black
Mat Siyah BoyaMP11
Gold
Altın RengiPC27
Matt Anthracite
Mat Antrasit BoyaMP30
Brushed Antique Brass
Fırçalanmış Antik PirinçPC35
Brushed Brass
Mat Sarı Boya

A 4198016

Material
Zinc AlloyMateryal
Zamak

Kod	Uzunluk	Merkez	Genişlik	Yükseklik
Code	Length	Central	Width	Height
A4198016	60 mm	16 mm	60 mm	26 mm

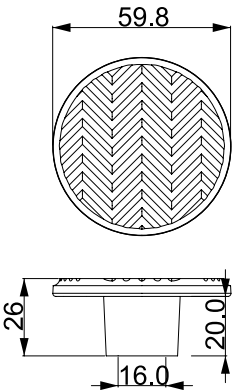
STANDARD FINISHES
STANDART RENKLERMP02
Chrome
KromPC24
Matt Black
Mat Siyah BoyaMP11
Gold
Altın RengiPC27
Matt Anthracite
Mat Antrasit BoyaMP30
Brushed Antique Brass
Fırçalanmış Antik PirinçPC35
Brushed Brass
Mat Sarı Boya

A 4197016

Material
Zinc AlloyMateryal
Zamak

Kod	Uzunluk	Merkez	Genişlik	Yükseklik
Code	Length	Central	Width	Height
A4197016	60 mm	16 mm	60 mm	26 mm

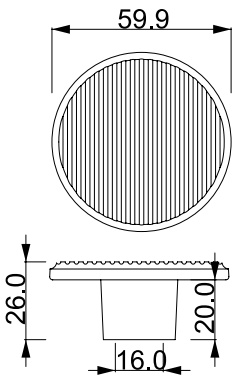
STANDARD FINISHES
STANDART RENKLERMP02
Chrome
KromPC24
Matt Black
Mat Siyah BoyaMP11
Gold
Altın RengiPC27
Matt Anthracite
Mat Antrasit BoyaMP30
Brushed Antique Brass
Fırçalanmış Antik PirinçPC35
Brushed Brass
Mat Sarı Boya

A 4196016

Material
Zinc AlloyMateryal
Zamak

Kod	Uzunluk	Merkez	Genişlik	Yükseklik
Code	Length	Central	Width	Height
A4196016	60 mm	16 mm	60 mm	26 mm

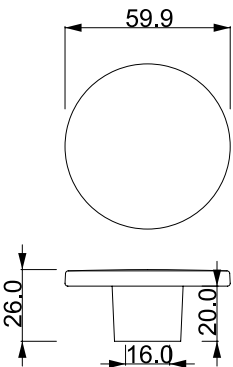
STANDARD FINISHES
STANDART RENKLERMP02
Chrome
KromPC24
Matt Black
Mat Siyah BoyaMP30
Brushed Antique Brass
Fırçalanmış Antik PirinçPC27
Matt Anthracite
Mat Antrasit BoyaPC35
Brushed Brass
Mat Sarı Boya

A 4195016

Material
Zinc AlloyMateriyal
Zamak

Kod	Uzunluk	Merkez	Genişlik	Yükseklik
Code	Length	Central	Width	Height
A4195016	60 mm	16 mm	60 mm	26 mm

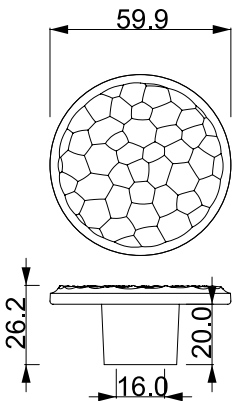
STANDARD FINISHES
STANDART RENKLERMP02
Chrome
KromPC24
Matt Black
Mat Siyah BoyaMP11
Gold
Altın RengiPC27
Matt Anthracite
Mat Antrasit BoyaMP30
Brushed Antique Brass
Fırçalanmış Antik PirinçPC35
Brushed Brass
Mat Sarı Boya

A 4194016

Material
Zinc AlloyMateryal
Zamak

Kod	Uzunluk	Merkez	Genişlik	Yükseklik
Code	Length	Central	Width	Height
A4194016	60 mm	16 mm	60 mm	26 mm

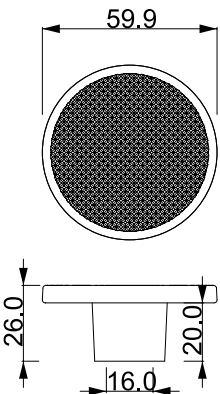
STANDARD FINISHES
STANDART RENKLERMP02
Chrome
KromPC24
Matt Black
Mat Siyah BoyaMP11
Gold
Altın RengiPC27
Matt Anthracite
Mat Antrasit BoyaMP30
Brushed Antique Brass
Fırçalanmış Antik PirinçPC35
Brushed Brass
Mat Sarı Boya

A 4193016

Material
Zinc AlloyMateriyal
Zamak

Kod	Uzunluk	Merkez	Genişlik	Yükseklik
Code	Length	Central	Width	Height
A4193016	60 mm	16 mm	60 mm	26 mm

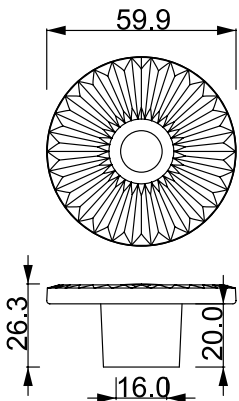
STANDARD FINISHES
STANDART RENKLERMP02
Chrome
KromPC24
Matt Black
Mat Siyah BoyaMP11
Gold
Altın RengiPC27
Matt Anthracite
Mat Antrasit BoyaMP30
Brushed Antique Brass
Fırçalanmış Antik PirinçPC35
Brushed Brass
Mat Sarı Boya

A 4180016

Material
Zinc AlloyMateryal
Zamak

Kod	Uzunluk	Merkez	Genişlik	Yükseklik
Code	Length	Central	Width	Height
A4180016	34 mm	16 mm	34 mm	30 mm

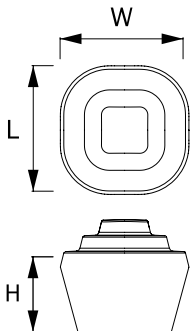

A 4180016

STANDARD FINISHES
STANDART RENKLERPC24
Matt Black
Mat Siyah BoyaPC27
Matt Anthracite
Mat Antrasit BoyaPC35
Brushed Brass
Mat Sarı Boya

A 4140016



A 4126002



A 4126001



Material
Zinc Alloy

Materyal
Zamak

Kod	Uzunluk	Merkez	Genişlik	Yükseklik	Renk
Code	Length	Central	Width	Height	Colour
A4140016	32 mm	16mm	16 mm	27 mm	MP10/PC24
A4126002	40 mm	-	40 mm	30 mm	MP08/PC24/PC27/PC35
A4126001	20 mm	-	20 mm	30 mm	MP08/PC24/PC27/PC35

STANDARD FINISHES
STANDART RENKLER



MP10
Antique Bronze
Antik Bronz



PC24
Matt Black
Mat Siyah Boya



MP08
Bright Brushed Inox
Nikel Satine



PC27
Matt Anthracite
Mat Antrasit Boya



PC35
Brushed Brass
Mat Sarı Boya

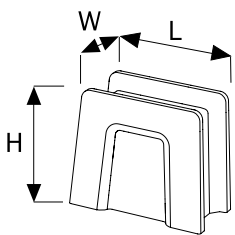

A 4140016

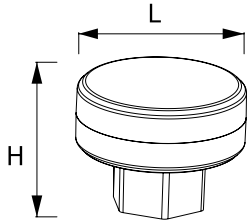

A 4126002

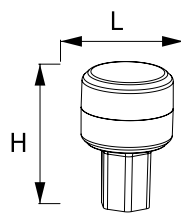

A 4126001

A 4130002
001Material
Zinc AlloyMateryal
Zamak

Kod	Uzunluk	Merkez	Genişlik	Yükseklik
Code	Length	Central	Width	Height
A4130002	41 mm	-	41 mm	27 mm
A4130001	25 mm	-	25 mm	27 mm

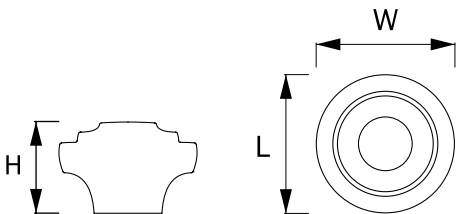
STANDARD FINISHES
STANDART RENKLERMP02
Chrome
KromPC24
Matt Black
Mat Siyah BoyaMP30
Brushed Antique Brass
Fırçalanmış Antik PiriñPC27
Matt Anthracite
Mat Antrasit BoyaPC35
Brushed Brass
Mat Sarı Boya

A 4128002
001



Material
Zinc Alloy

Materyal
Zamak

Kod	Uzunluk	Merkez	Genişlik	Yükseklik
Code	Length	Central	Width	Height
A4128002	30 mm	-	30 mm	27 mm
A4128001	20 mm	-	20 mm	27 mm

STANDARD FINISHES
STANDART RENKLER



MP02
Chrome
Krom



PC24
Matt Black
Mat Siyah Boya



MP08
Nikel Satine



PC35
Brushed Brass
Mat Sarı Boya

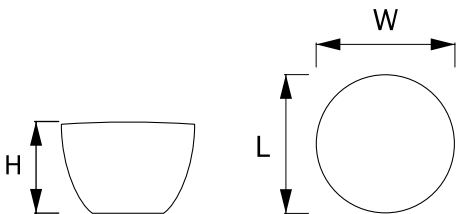

A 4124016



A 4121016



A 4119016



Material
Zinc Alloy

Materyal
Zamak

Kod	Uzunluk	Merkez	Genişlik	Yükseklik	Renk
Code	Length	Central	Width	Height	Colour
A4124016	60 mm	16 mm	22 mm	41 mm	MP11/MP30/PC24/PC27/PC35
A4121016	50 mm	16 mm	21 mm	38 mm	MP11/MP30/PC24/PC27/PC35
A4119016	50 mm	16 mm	20 mm	36 mm	MP02/MP11/MP30/PC24/PC27/

STANDARD FINISHES
STANDART RENKLER



MP02
Chrome
Krom



PC24
Matt Black
Mat Siyah Boya



MP11
Gold
Altın Rengi



PC27
Matt Anthracite
Mat Antrasit Boya



MP30
Brushed Antique Brass
Firçalanmış Antik Pirinç



PC35
Brushed Brass
Mat Sarı Boya

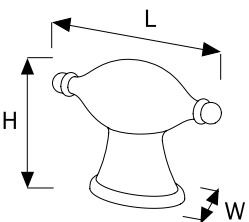

A 4124016

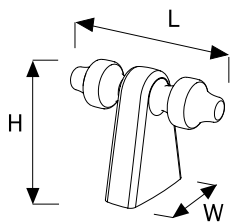

A 4121016

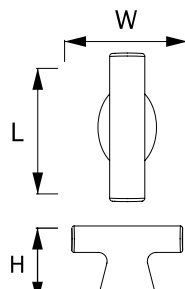

A 4119016

A 4117016



A 4113032



A 4111016



Material
Zinc Alloy

Materyal
Zamak

Kod	Uzunluk	Merkez	Genişlik	Yükseklik	Renk
Code	Length	Central	Width	Height	Colour
A4117016	56 mm	16 mm	22 mm	37 mm	MP02/MP08/MP11/MP30/PC24
A4113032	53 mm	32 mm	12 mm	30 mm	MP02/MP08/PC24/PC27/PC35
A4111016	40 mm	16 mm	17 mm	26 mm	MP08/MP11/PC24

STANDARD FINISHES
STANDART RENKLER



MP02
Chrome
Krom



MP30
Brushed Antique Brass
Fırçalanmış Antik Pirinç



PC24
Matt Black
Mat Siyah Boya



MP08
Bright Brushed Inox
Nikel Satine



PC27
Matt Anthracite
Mat Antrasit Boya



MP11
Gold
Altın Rengi



PC35
Brushed Brass
Mat Sarı Boya

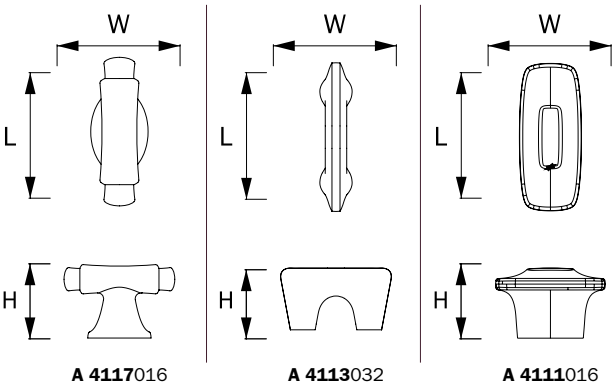

A 4108001



A 4110016



A 4107001

Material
Zinc AlloyMateryal
Zamak

Kod	Uzunluk	Merkez	Genişlik	Yükseklik	Renk
Code	Length	Central	Width	Height	Colour
A4110016	60 mm	16 mm	16 mm	36 mm	MP08/PC24/PC27/PC35
A4108001	50 mm	-	19 mm	32 mm	MP08/MP11/PC24/PC35
A4107001	54 mm	-	16 mm	30 mm	MP02/MP08/PC24/PC35

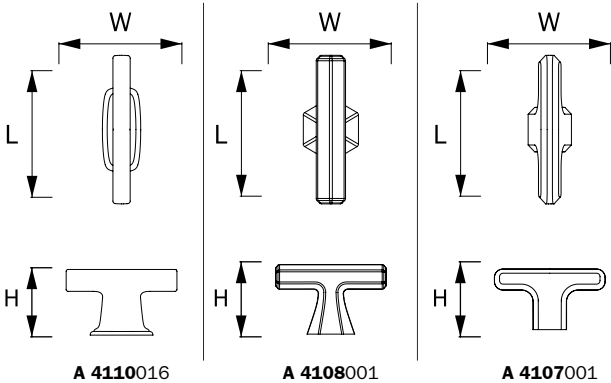
STANDARD FINISHES
STANDART RENKLERMP02
Chrome
KromPC24
Matt Black
Mat Siyah BoyaMP08
Bright Brushed Inox
Nikel SatinePC27
Matt Anthracite
Mat Antrasit BoyaMP11
Gold
Altın RengiPC35
Brushed Brass
Mat Sarı Boya

A 4106016

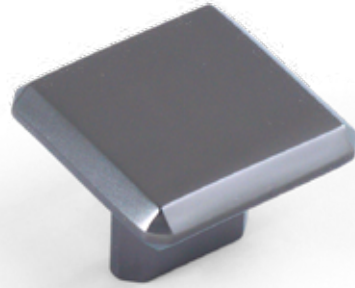

A 4105001



A 4104016



Material
Zinc Alloy

Materyal
Zamak

Kod	Uzunluk	Merkez	Genişlik	Yükseklik	Renk
Code	Length	Central	Width	Height	Colour
A4106016	40 mm	16 mm	40 mm	28 mm	MP02/MP08/PC24/PC27/PC35
A4105001	20 mm	-	20 mm	24 mm	MP08/MP30/PC24/PC35
A4104016	61 mm	16 mm	20 mm	28 mm	MP02/MP30/PC24/PC35

STANDARD FINISHES
STANDART RENKLER



MP02
Chrome
Krom



PC24
Matt Black
Mat Siyah Boya



MP08
Bright Brushed Inox
Nikel Satine



PC27
Matt Anthracite
Mat Antrasit Boya



MP30
Brushed Antique Brass
Fırçalanmış Antik Pirinç



PC35
Brushed Brass
Mat Sarı Boya

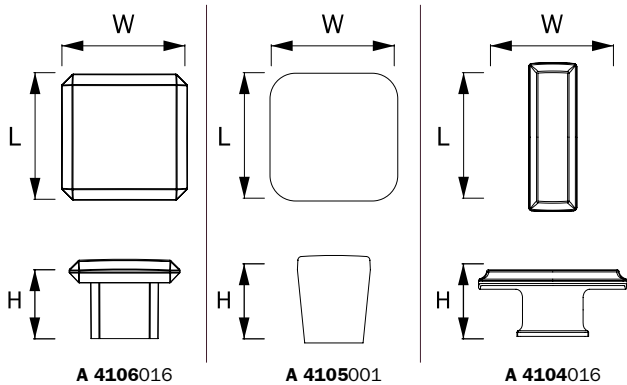

A 4102003



A 4102002

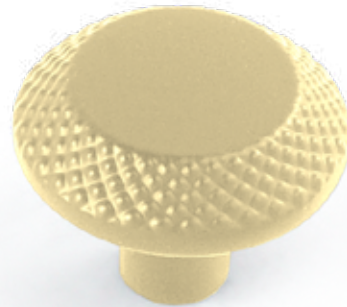

A 4102001

Material
Zinc AlloyMateryal
Zamak

Kod	Uzunluk	Merkez	Genişlik	Yükseklik	Renk
Code	Length	Central	Width	Height	Colour
A4102003	60 mm	-	60 mm	22 mm	MP11/MP30/PC24/PC27/PC35
A4102002	45 mm	-	45 mm	22 mm	MP11/MP30/PC24/PC27/PC35
A4102001	30 mm	-	30 mm	22 mm	MP11/MP30/PC24/PC27/PC35

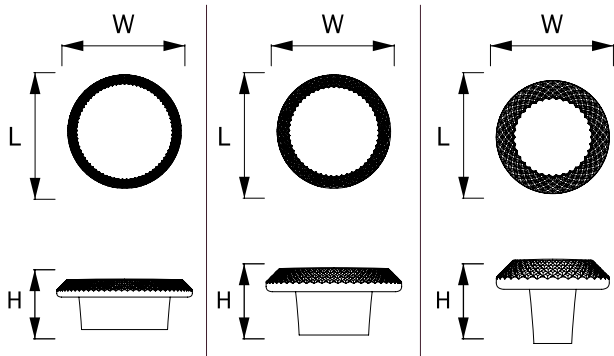
STANDARD FINISHES
STANDART RENKLERMP02
Chrome
KromPC24
Matt Black
Mat Siyah BoyaMP11
Gold
Altın RengiPC27
Matt Anthracite
Mat Antrasit BoyaMP30
Brushed Anthique Brass
Fırçalanmış Antik PiringPC35
Brushed Brass
Mat Sarı Boya

A 4103001



A 4101016



A 372016



Material
Zinc Alloy

Materyal
Zamak

Kod	Uzunluk	Merkez	Genişlik	Yükseklik	Renk
Code	Length	Central	Width	Height	Colour
A4103001	40 mm	-	8 mm	33 mm	MP08/PC24/PC27/PC35
A4101016	59 mm	16 mm	19 mm	27 mm	MP30/PC24/PC27/PC35
A372016	51 mm	16 mm	20 mm	25 mm	MP02/MP08/PC24/PC35

STANDARD FINISHES
STANDART RENKLER



MP02
Chrome
Krom



PC24
Matt Black
Mat Siyah Boya



MP08
Bright Brushed Inox
Nikel Satine



PC27
Matt Anthracite
Mat Antrasit Boya



MP30
Brushed Antique Brass
Fırçalanmış Antik Pirinç



PC35
Brushed Brass
Mat Sarı Boya

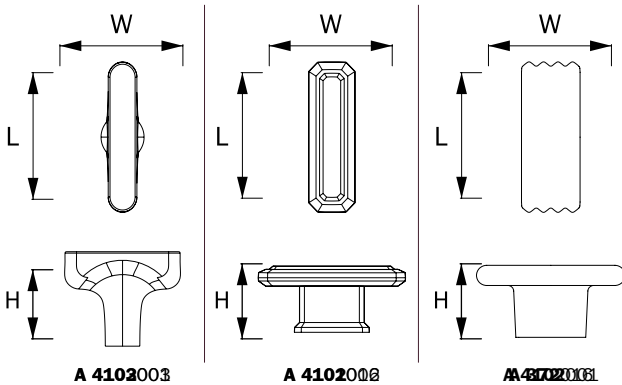

B 4253001**B 4237001****B 4234001****B 4253001****B 4237001****B 4234001**Material
Zinc Alloy
ALMaterial
Zağnak
&
Alüminyum

Kod	Uzunluk	Merkez
Code	Width	Height
B4234001	22 mm	30 mm
B4237001	22 mm	30 mm
B4253001	22 mm	30 mm

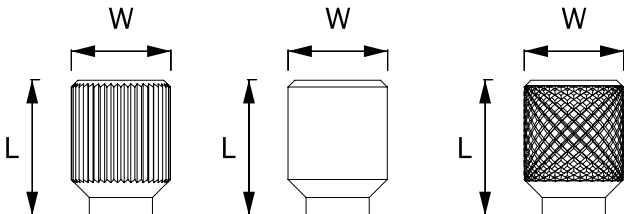
STANDARD FINISHES
STANDART RENKLERMP30
Brushed Antique Brass
Fırçalanmış Antik PiringPC24
Matt Black
Mat Siyah BoyaPC27
Matt Anthracite
Mat Antrasit BoyaPC35
Brushed Brass
Mat Sarı Boya

B 4253002
B 4237002
B 4234002



B 4237002



B 4253002



B 4234002

Material
Zinc Alloy
AL

Material
Zağnak
&
Alüminyum

Kod	Uzunluk	Merkez
Code	Width	Height
B4234002	35 mm	30 mm
B4237002	35 mm	30 mm
B4253002	35 mm	30 mm

STANDARD FINISHES
STANDART RENKLER



MP30
Brushed Antique Brass
Fırçalanmış Antik Piring



PC24
Matt Black
Mat Siyah Boya



PC27
Matt Anthracite
Mat Antrasit Boya



PC35
Brushed Brass
Mat Sarı Boya

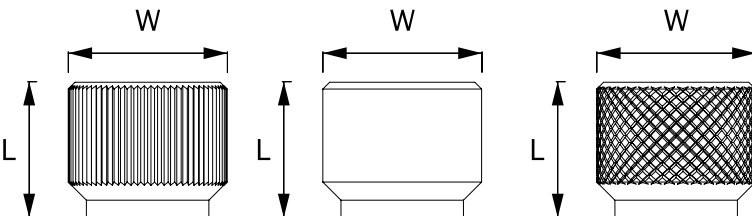

B 4254001**B 4238001****B 4235001****B 4238001****B 4254001****B 4235001**Material
Zinc Alloy
ALMaterial
Zağnak
&
Alüminyum

Kod	Uzunluk	Merkez
Code	Width	Height
B4235001	22 mm	30 mm
B4238001	22 mm	30 mm
B4254001	22 mm	30 mm

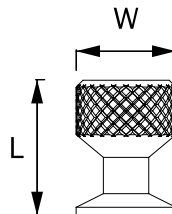
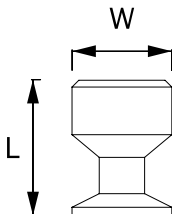
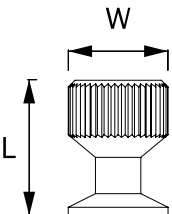
STANDARD FINISHES
STANDART RENKLERMP30
Brushed Antique Brass
Fırçalanmış Antik PiringPC24
Matt Black
Mat Siyah BoyaPC27
Matt Anthracite
Mat Antrasit BoyaPC35
Brushed Brass
Mat Sarı Boya

B 4254002**B 4238002****B 4235002****B 4238002****B 4254002****B 4235002**Material
Zinc Alloy
ALMaterial
Zağnak
&
Alüminyum

Kod	Uzunluk	Merkez
Code	Width	Height
B4235002	35 mm	30 mm
B4238002	35 mm	30 mm
B4254002	35 mm	30 mm

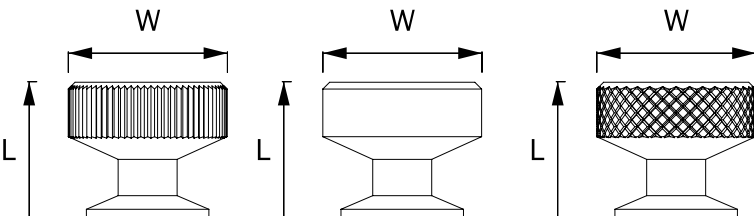
STANDARD FINISHES
STANDART RENKLERMP30
Brushed Antique Brass
Fırçalanmış Antik PiringPC24
Matt Black
Mat Siyah BoyaPC27
Matt Anthracite
Mat Antrasit BoyaPC35
Brushed Brass
Mat Sarı Boya

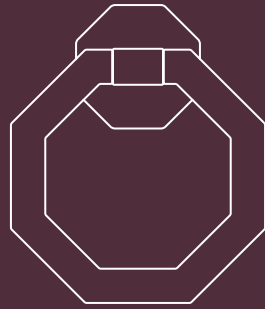

FURNITURE
PENDANTS
SARKAÇLAR

Discover new passions



A 496-9155

Material
Zinc AlloyMateriyal
Zamak

Kod	Uzunluk	Genişlik
Code	Length	Width
A496-9155	85 mm	74 mm

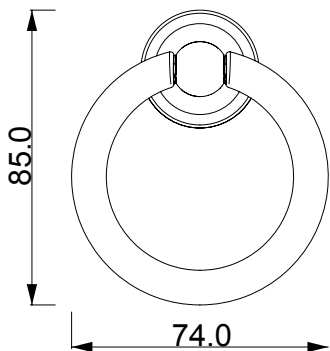
STANDARD FINISHES
STANDART RENKLERMP02
Chrome
KromMP10
Antique Bronze
Antik BronzPC24
Matt Black
Mat Siyah BoyaMP11
Gold
Altın RengiPC27
Matt Anthracite
Mat Antrasit BoyaMP14
Antique Silver
Antik GümüşPC35
Brushed Brass
Mat Sarı Boya

A 496-9154

Material
Zinc AlloyMateryal
Zamak

Kod	Uzunluk	Genişlik
Code	Length	Width
A496-9154	85 mm	74 mm

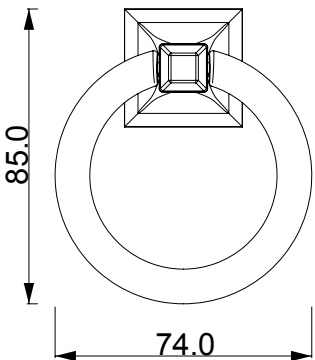
STANDARD FINISHES
STANDART RENKLERMP02
Chrome
KromMP10
Antique Bronze
Antik BronzPC24
Matt Black
Mat Siyah BoyaMP11
Gold
Altın RengiPC27
Matt Anthracite
Mat Antrasit BoyaMP14
Antique Silver
Antik GümüşPC35
Brushed Brass
Mat Sarı Boya

A 492-9155

Material
Zinc AlloyMateriyal
Zamak

Kod	Uzunluk	Genişlik
Code	Length	Width
A492-9155	86 mm	35 mm

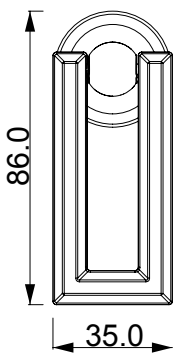
STANDARD FINISHES
STANDART RENKLERMP02
Chrome
KromMP10
Antique Bronze
Antik BronzPC24
Matt Black
Mat Siyah BoyaMP11
Gold
Altın RengiPC27
Matt Anthracite
Mat Antrasit BoyaMP14
Antique Silver
Antik GümüşPC35
Brushed Brass
Mat Sarı Boya

A 492-9154

Material
Zinc AlloyMateryal
Zamak

Kod	Uzunluk	Genişlik
Code	Length	Width
A492-9154	86 mm	35 mm

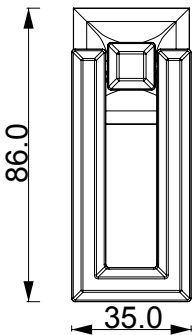
STANDARD FINISHES
STANDART RENKLERMP02
Chrome
KromMP10
Antique Bronze
Antik BronzPC24
Matt Black
Mat Siyah BoyaMP11
Gold
Altın RengiPC27
Matt Anthracite
Mat Antrasit BoyaMP14
Antique Silver
Antik GümüşPC35
Brushed Brass
Mat Sarı Boya

A 492-9152

Material
Zinc AlloyMaterial
Zinc Alloy
Zamak

Kod	Uzunluk	Genişlik
Code	Length	Width
A492-9152	80 mm	35 mm

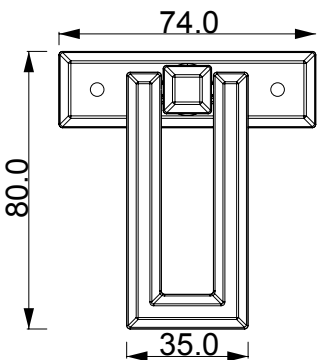
STANDARD FINISHES
STANDART RENKLERMP02
Chrome
KromMP10
Antique Bronze
Antik BronzPC24
Matt Black
Mat Siyah BoyaMP11
Gold
Altın RengiPC27
Matt Anthracite
Mat Antrasit BoyaMP14
Antique Silver
Antik GümüşPC35
Brushed Brass
Mat Sarı Boya

A 492-9150

Material
Zinc AlloyMaterial
Zinc Alloy
Zamak

Kod	Uzunluk	Genişlik
Code	Length	Width
A492-9150	94 mm	35 mm

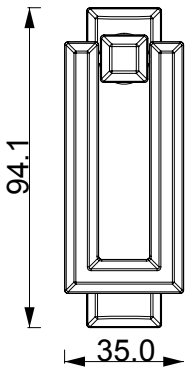
STANDARD FINISHES
STANDART RENKLERMP02
Chrome
KromMP10
Antique Bronze
Antik BronzPC24
Matt Black
Mat Siyah BoyaMP11
Gold
Altın RengiPC27
Matt Anthracite
Mat Antrasit BoyaMP14
Antique Silver
Antik GümüşPC35
Brushed Brass
Mat Sarı Boya

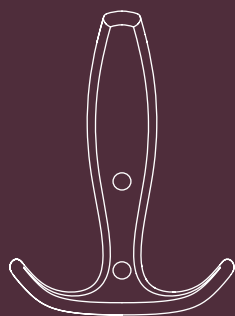

COAT HOOKS
MODERN ASKILAR

Discover new passions



A 7113020
010Material
Zinc AlloyMateryal
Zamak

Kod	Uzunluk	Merkez	Genişlik
Code	Length	Width	Height
A7113020	110 mm	92 mm	49 mm
A7113010	116 mm	22 mm	48 mm

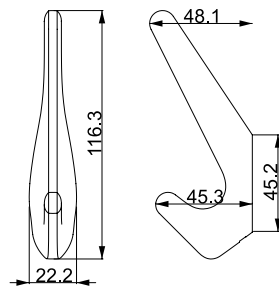
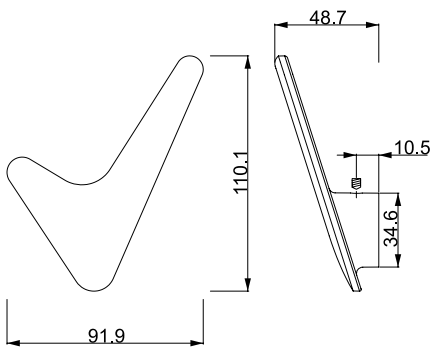
STANDARD FINISHES
STANDART RENKLERMP02
Chrome
KromPC24
Matt Black
Mat Siyah BoyaMP08
Bright Brushed Inox
Nikel SatinePC27
Matt Anthracite
Mat Antrasit BoyaMP11
Gold
Altın RengiPC35
Brushed Brass
Mat Sarı Boya

A 7106020
010

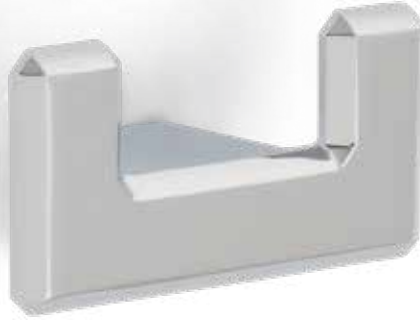

Material
Zinc Alloy

Materyal
Zamak

Kod	Uzunluk	Merkez	Genişlik
Code	Length	Width	Height
A7106020	40 mm	79 mm	34 mm
A7106010	61 mm	20 mm	34 mm

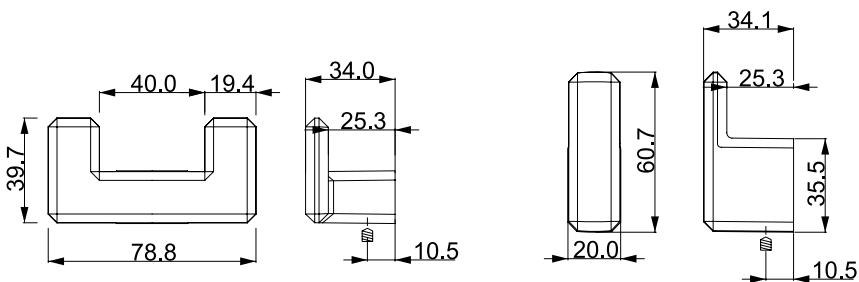

STANDARD FINISHES
STANDART RENKLER



MP02
Chrome
Krom



PC24
Matt Black
Mat Siyah Boya



MP08
Bright Brushed Inox
Nikel Satine



PC27
Matt Anthracite
Mat Antrasit Boya



MP11
Gold
Altun Rengi

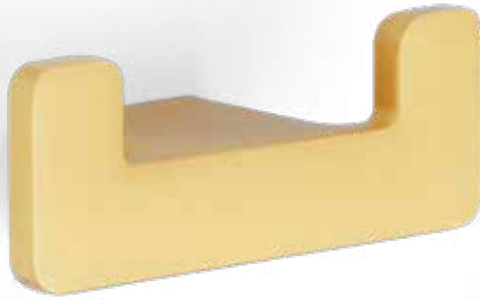

PC35
Brushed Brass
Mat Sarı Boya

A 7105020
010Material
Zinc AlloyMateryal
Zamak

Kod	Uzunluk	Merkez	Genişlik
Code	Length	Width	Height
A7105020	31 mm	79 mm	34 mm
A7105010	58 mm	17 mm	34 mm

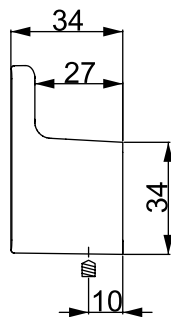
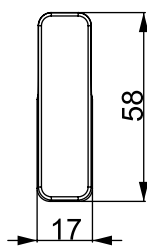
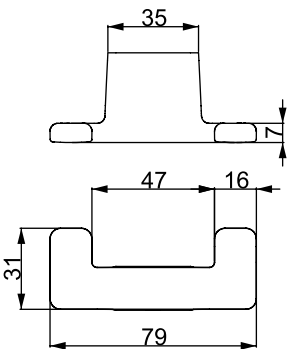
STANDARD FINISHES
STANDART RENKLERMP02
Chrome
KromPC24
Matt Black
Mat Siyah BoyaMP08
Bright Brushed Inox
Nikel SatinePC27
Matt Anthracite
Mat Antrasit BoyaMP30
Brushed Antique Brass
Fırçalanmış Antik PirinçPC35
Brushed Brass
Mat Sarı Boya

A 7104010

Material
Zinc AlloyMateryal
Zamak

Kod	Uzunluk	Merkez	Genişlik
Code	Length	Width	Height
A7104010	70 mm	25 mm	35 mm

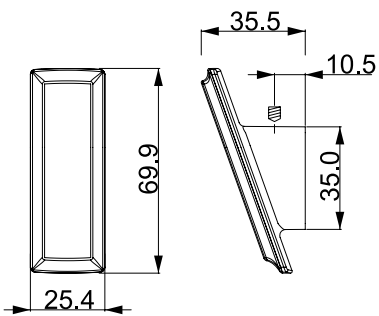
STANDARD FINISHES
STANDART RENKLERMP02
Chrome
KromMP14
Antique Silver
Antik GümüşPC24
Matt Black
Mat Siyah BoyaMP08
Bright Brushed Inox
Nikel SatinePC27
Matt Anthracite
Mat Antrasit BoyaPC35
Brushed Brass
Mat Sarı BoyaMP11
Gold
Altın RengiMP30
Brushed Antique Brass
Fırçalanmış Antik Pirinç

A 7101020

Material
Zinc AlloyMateryal
Zamak

Kod	Uzunluk	Merkez	Genişlik
Code	Length	Width	Height
A7101020	100 mm	60 mm	55 mm

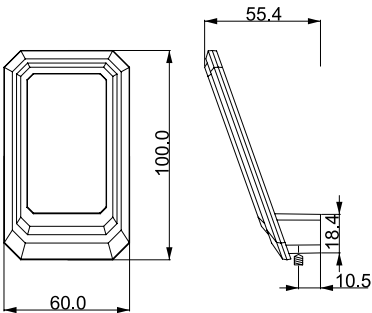
STANDARD FINISHES
STANDART RENKLERMP02
Chrome
KromMP11
Gold
Altın RengiPC24
Matt Black
Mat Siyah BoyaMP14
Antique Silver
Antik GümüşPC27
Matt Anthracite
Mat Antrasit BoyaMP30
Brushed Antique Brass
Fırçalanmış Antik PirinçPC35
Brushed Brass
Mat Sarı Boya

A 7101010

Material
Zinc AlloyMateryal
Zamak

Kod	Uzunluk	Merkez	Genişlik
Code	Length	Width	Height
A7101010	70 mm	25 mm	38 mm

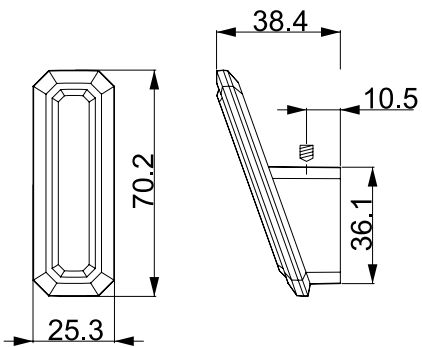
STANDARD FINISHES
STANDART RENKLERMP02
Chrome
KromMP11
Gold
Altın RengiPC24
Matt Black
Mat Siyah BoyaMP14
Antique Silver
Antik GümüşPC27
Matt Anthracite
Mat Antrasit BoyaMP30
Brushed Antique Brass
Fırçalanmış Antik PirinçPC35
Brushed Brass
Mat Sarı Boya

A 750

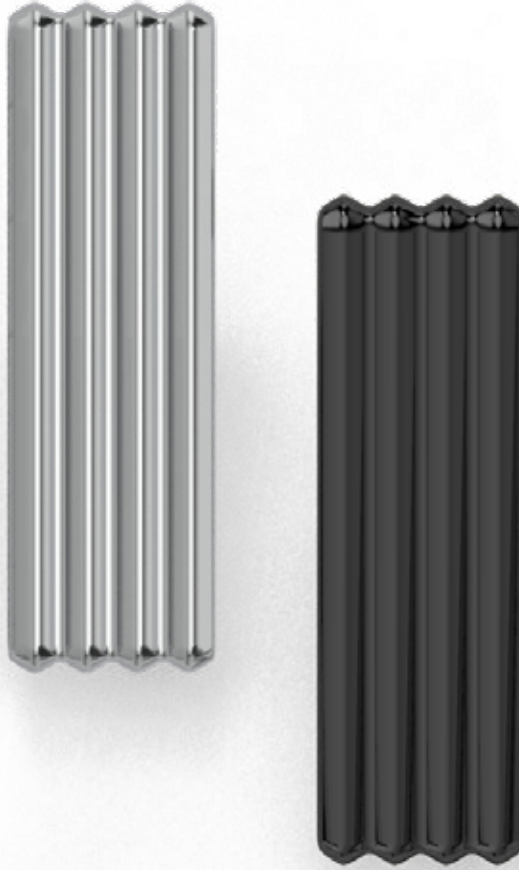
Material
Zinc AlloyMateryal
Zamak

Kod	Uzunluk	Merkez	Genişlik
Code	Length	Width	Height
A750000	85 mm	26 mm	39 mm

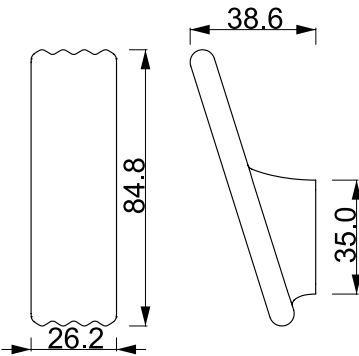
STANDARD FINISHES
STANDART RENKLERMP02
Chrome
KromPC24
Matt Black
Mat Siyah BoyaMP08
Bright Brushed Inox
Nikel SatinePC27
Matt Anthracite
Mat Antrasit BoyaPC35
Brushed Brass
Mat Sarı Boya

A 720



A 713



Material
Zinc Alloy

Materyal
Zamak

Kod	Uzunluk	Merkez	Genişlik	Renk
Code	Length	Width	Height	Colour
A720000	110 mm	74 mm	43 mm	MP02/PC05/MP08/PC24
A713000	109 mm	80 mm	30 mm	MP02/PC04/PC05/MP08/MP11/MP19/PC24

STANDARD FINISHES
STANDART RENKLER

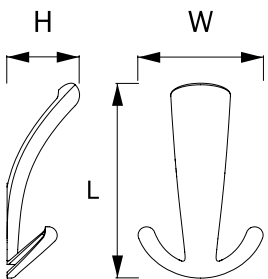
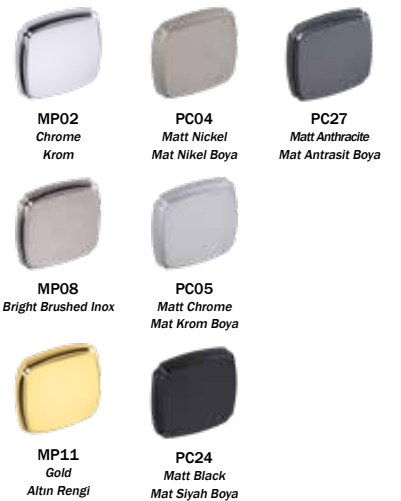

A 720

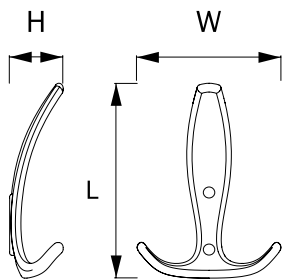

A 713



EMPIRE
COLLECTION



CLASSIC FURNITURE
HANDLES & KNOBS
KLASİK MOBİLYA
KULPLARI VE DÜĞMELERİ

Discover new passions



A 364128
096
016



Material
Zinc Alloy

Materyal
Zamak

Kod	Uzunluk	Merkez	Genişlik	Yükseklik
Code	Length	Central	Width	Height
A364128	152 mm	128 mm	22 mm	27 mm
A364096	120 mm	96 mm	22 mm	27 mm
A364016	38 mm	16 mm	22 mm	21 mm

STANDARD FINISHES
STANDART RENKLER



MP10
Antique Bronze
Antik Bronz



PC24
Matt Black
Mat Siyah Boya



PC27
Matt Anthracite
Mat Antrasit Boya



PC35
Brushed Brass
Mat Sarı Boya

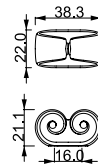
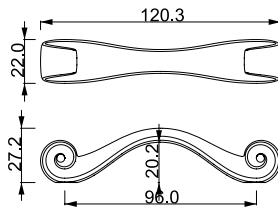
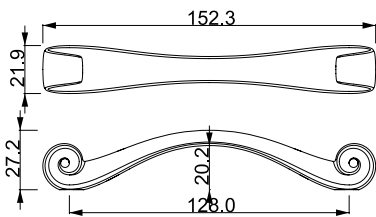

A 361128
096
025



Material
Zinc Alloy
AAS

Material
Zamak
AAS

Kod	Uzunluk	Merkez	Genişlik	Yükseklik
Code	Length	Central	Width	Height
A361128	150 mm	128 mm	22 mm	26 mm
A361096	118 mm	96 mm	22 mm	26 mm
A361025	22 mm	1 mm	22 mm	26 mm

STANDARD FINISHES
STANDART RENKLER



MP10
Antique Bronze
Antik Bronz



PC24
Matt Black
Mat Siyah Boya



PC27
Matt Anthracite
Mat Antrasit Boya



PC35
Brushed Brass
Mat Sarı Boya

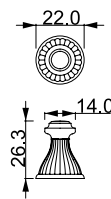
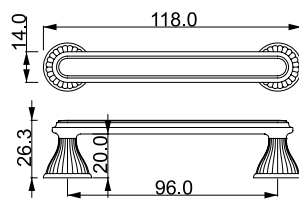
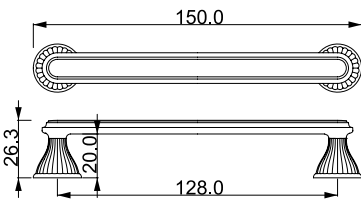

A 354320
160
096
032



Material
Zinc Alloy
AAS

Materyal
Zamak
AAS

Kod	Uzunluk	Merkez	Genişlik	Yükseklik
Code	Length	Central	Width	Height
A354320	346 mm	320 mm	26 mm	27 mm
A354160	186 mm	160 mm	26 mm	27 mm
A354096	122 mm	96 mm	26 mm	27 mm
A354032	58 mm	32 mm	26 mm	27 mm

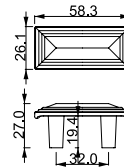
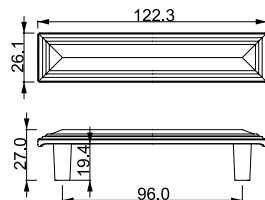
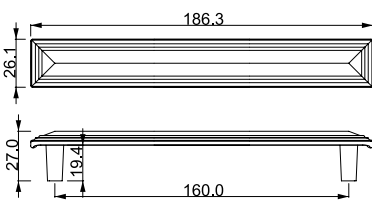
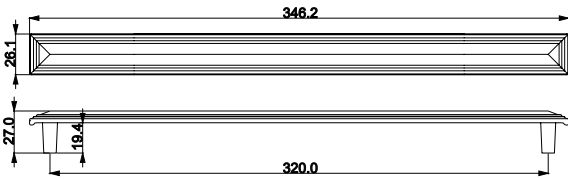

STANDARD FINISHES
STANDART RENKLER



MP10
Antique Bronze
Antik Bronz



PC24
Matt Black
Mat Siyah Boya



PC27
Matt Anthracite
Mat Antrasit Boya



PC35
Brushed Brass
Mat Sarı Boya

A 351160
096
025



Material
Zinc Alloy
ABS

Material
Zamak
ABS

Kod	Uzunluk	Merkez	Genişlik	Yükseklik
Code	Length	Central	Width	Height
A351160	184 mm	160 mm	23 mm	27 mm
A351096	120 mm	96 mm	23 mm	27 mm
A351025	34 mm	-	34 mm	26 mm

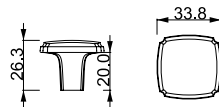
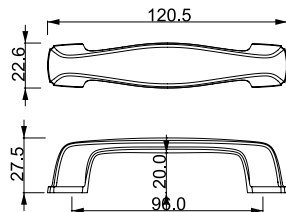
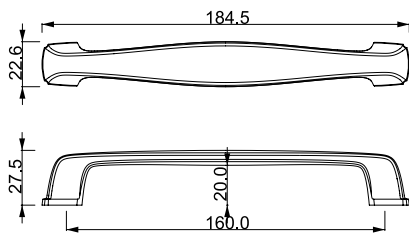

STANDARD FINISHES
STANDART RENKLER



MP08
Bright Brushed Inox
Nikel Satine



PC24
Matt Black
Mat Siyah Boya



MP10
Antique Bronze
Antik Bronz



PC27
Matt Anthracite
Mat Antrasit Boya



MP30
Brushed Antique Brass
Fırçalanmış Antik Pırnç



PC35
Brushed Brass
Mat Sarı Boya







EMPIRE
COLLECTION



CLASSIC FURNITURE KNOBS
KLASİK MOBİLYA DÜĞMELERİ

Discover new passions



A 364016



A 361025



A 354032



A 351025



Material
Zinc Alloy

Materyal
Zamak

Kod	Uzunluk	Merkez	Genişlik	Yükseklik	Renk
Code	Length	Central	Width	Height	Colour
A364016	38 mm	16 mm	22 mm	21 mm	MP10/PC24
A361025	22 mm	1 mm	22 mm	26 mm	MP10/PC24/PC27/PC35
A354032	58 mm	32 mm	26 mm	27 mm	MP10/PC24/MP27/PC35
A351025	34 mm	-	34 mm	26 mm	MP08/MP10/MP30/PC24/MP27

STANDARD FINISHES
STANDART RENKLER

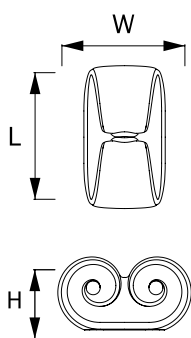

A 364016

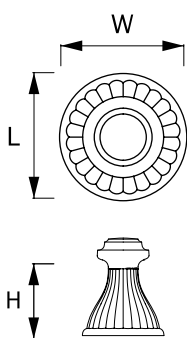

A 361025

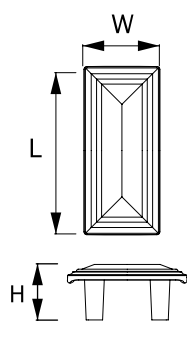

A 354032

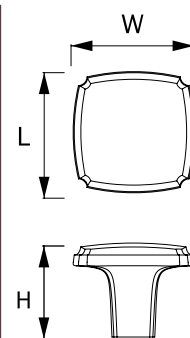

A 351025



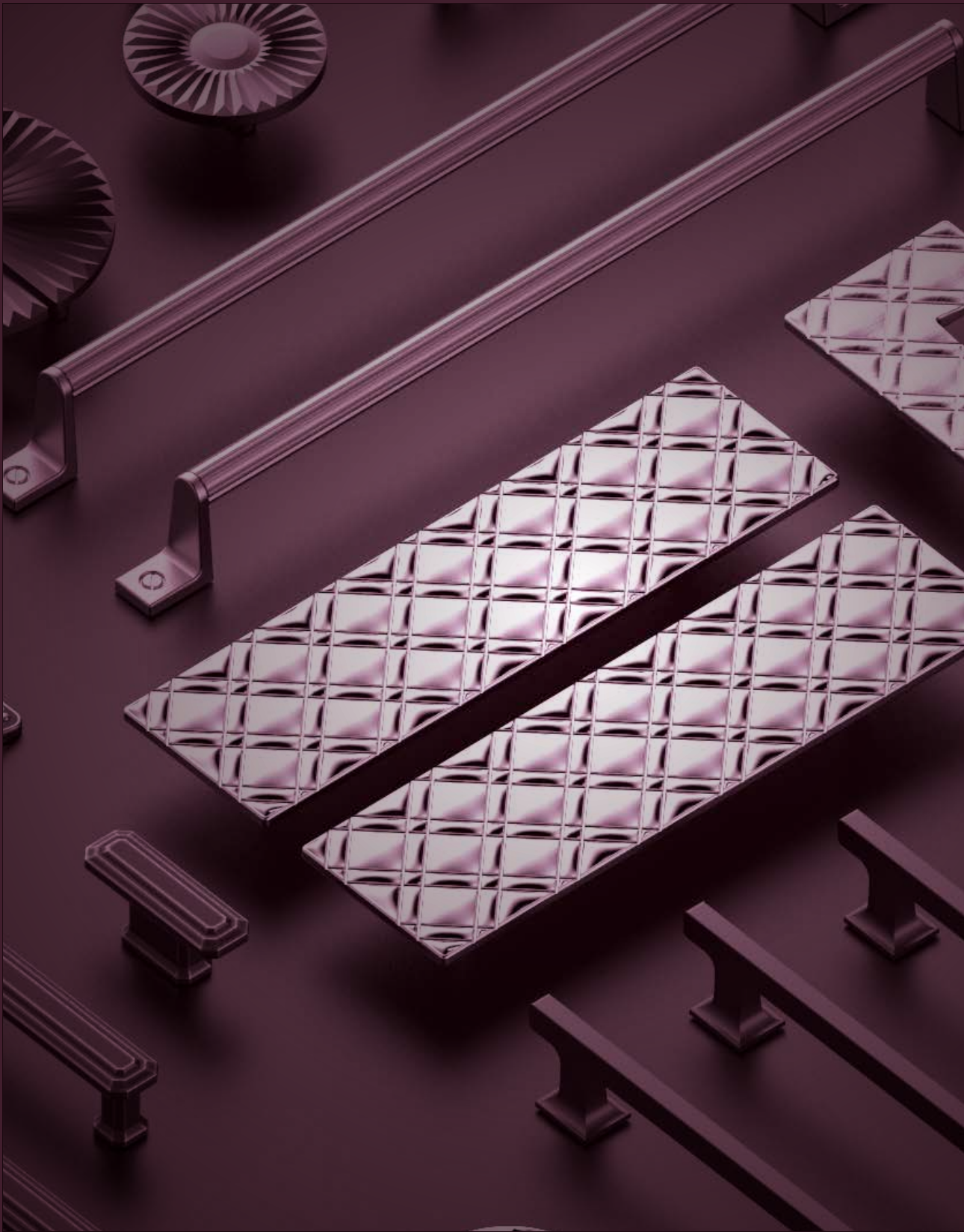

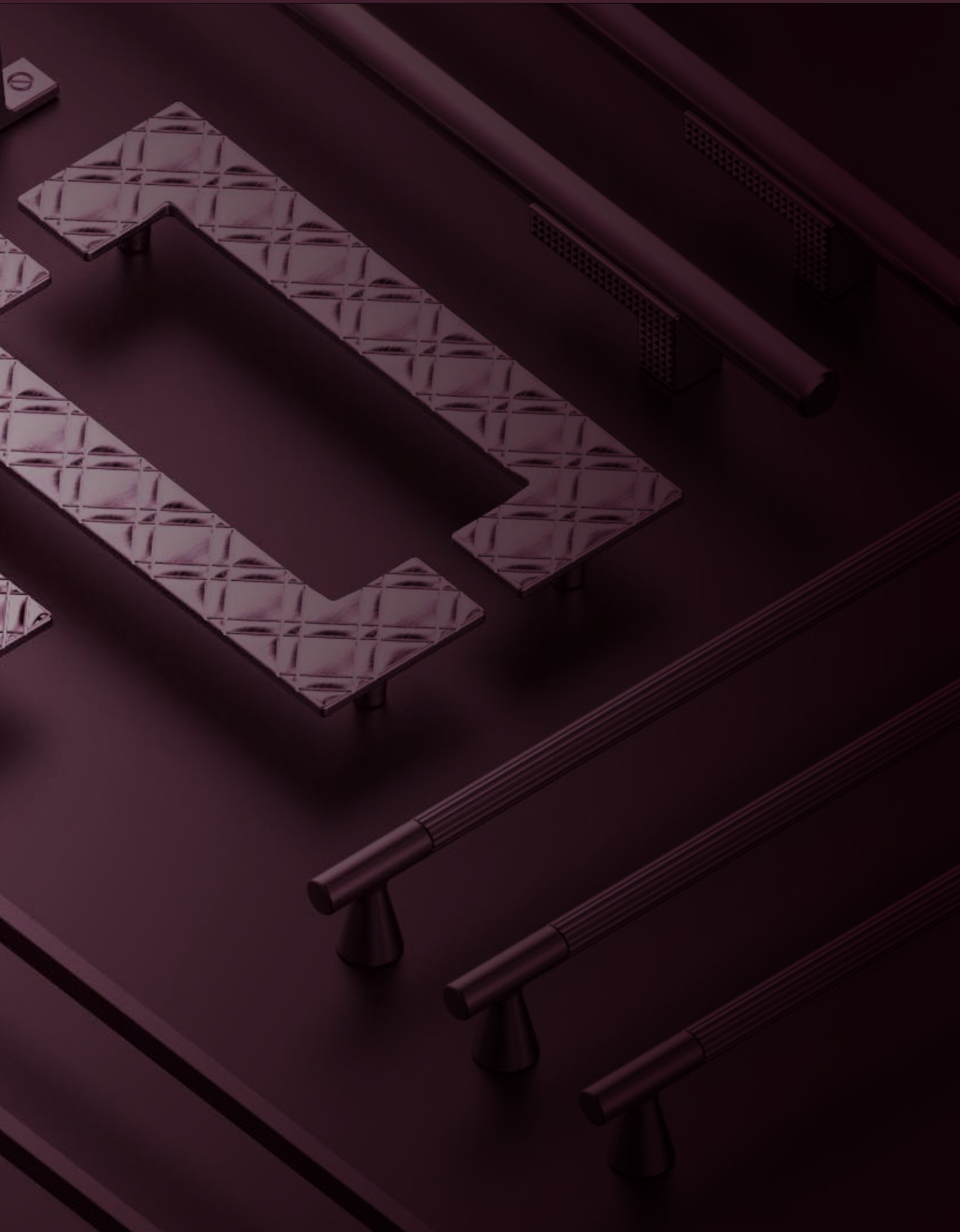



ART DEKORATİF ÜRÜNLER TASARIM A.Ş.
Organize Sanayi Bölgesi 1. Cd.
No : 17 Merkez Çanakkale
Tel: 4445857
mail:destek@cebidesign.com

