

4 ADET



6 ADET



9 ADET



40 ADET

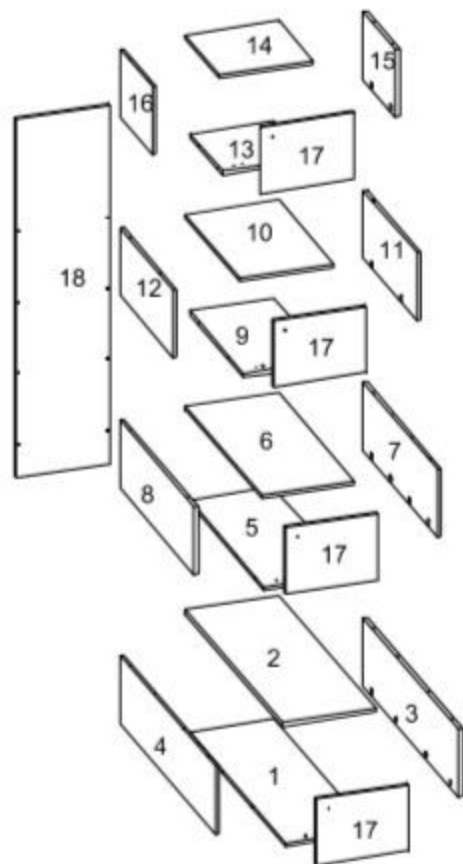
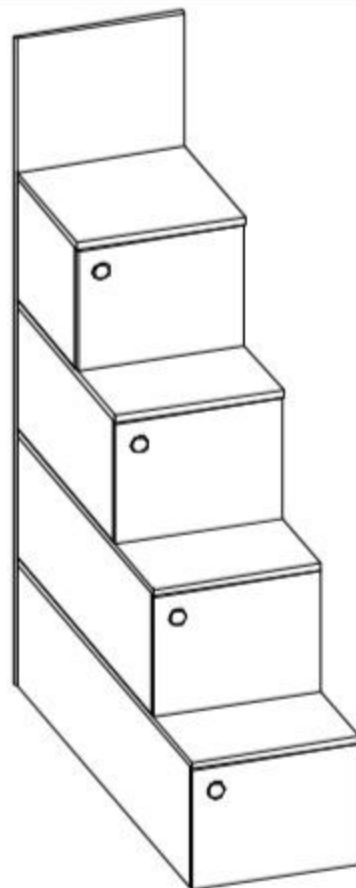

8 ADET

4.  
BLOK3.  
BLOK2.  
BLOK1.  
BLOK

KULP	M4*22 KULP VİDASI	KABİN VİDASI	3,5*18 VİDA	DÜZ MENTEŞE	MENTEŞE ALTLIK
4 AD	4 AD	8 AD	32 AD	8 AD	8 AD

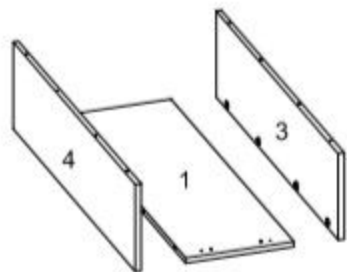

DİĞER BLOKLARI BU  
BLOK GİBİ TOPLAYINIZ !!!

01

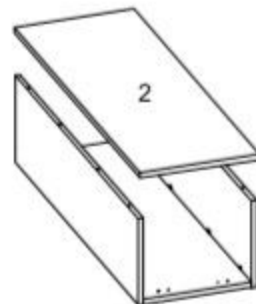

DİĞER BLOKLARI BU  
BLOK GİBİ TOPLAYINIZ !!!

02



03

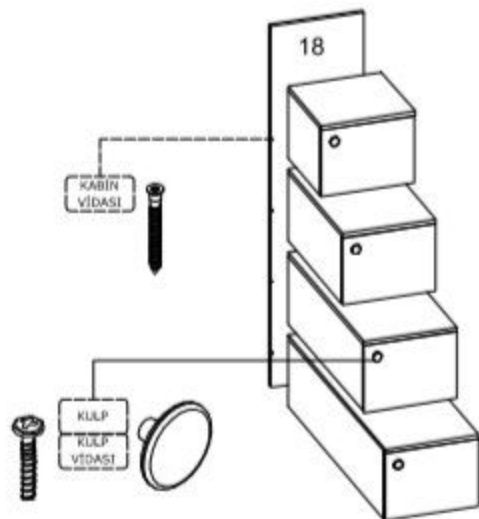

04

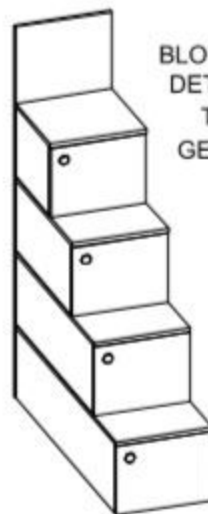

BLOKLARI TOPLARKEN  
DETAYA (UZUN OLAN  
TABLANIN ÜSTE  
GELDİĞİNE) DİKKAT  
EDİNİZ.

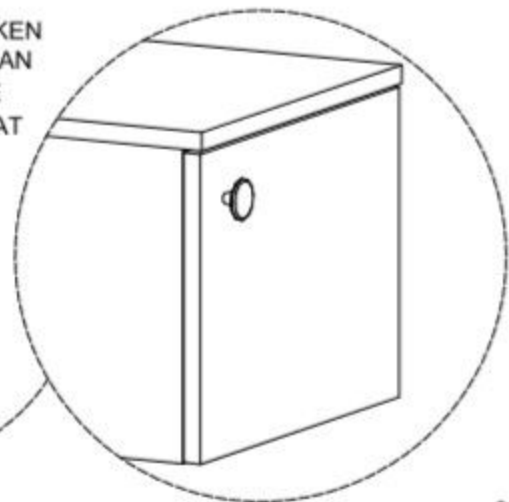

05

KABIN  
VİDASI

01

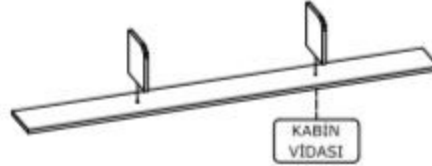

02

3,5\*18  
VİDA  
KARYOLA  
L DEMİR

03

KABIN  
VİDASIYILDIZ  
BAŞLI  
SOMUNLU  
KÜTÜPHANE  
BAĞLANTI  
(4 ADET)

04

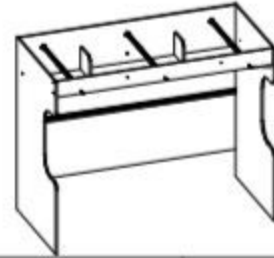

05

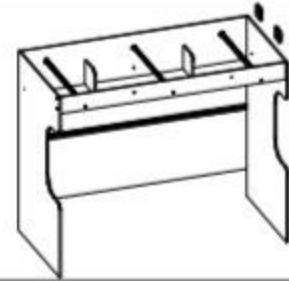

06

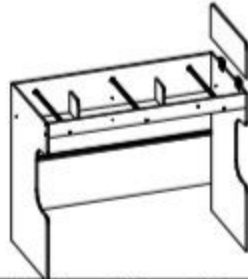

07

KÜTÜPHANE  
BAĞLANTI  
(6 ADET)

08

KÜTÜPHANE  
BAĞLANTI  
(6 ADET)



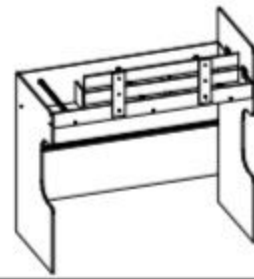

09

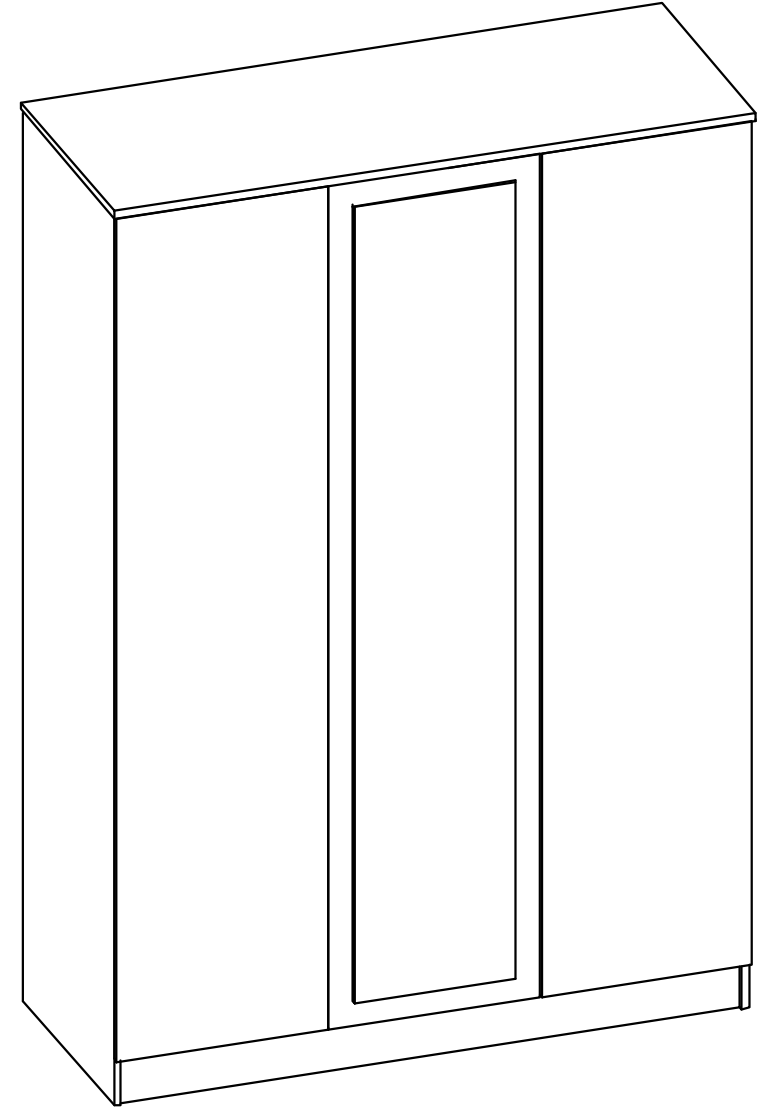
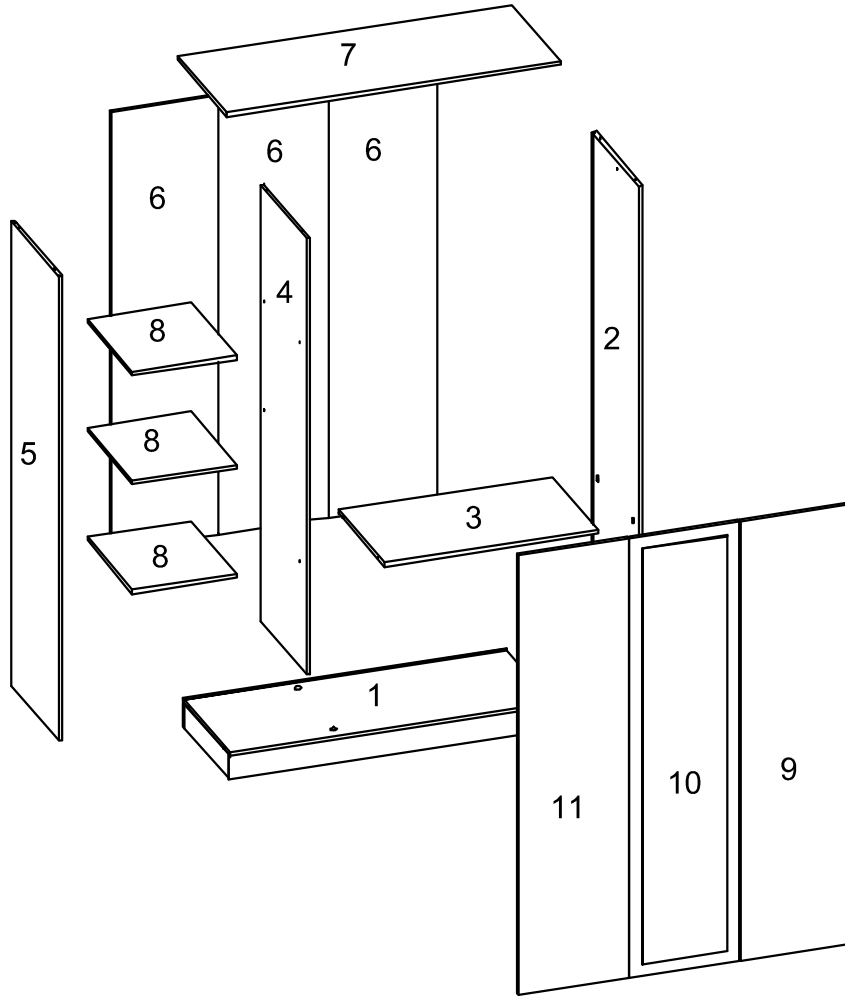

KARYOLA L DEMİR	KABIN VİDASI	3,5*18 VİDA	KULP	DÜZ MENTEŞE	MENTEŞE ALTIKLIK	M4*22 KULP VİDASI
2 AD	24 AD	32 AD	4 AD	8 AD	8 AD	4 AD

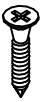
Yedek parçaya ihtiyaç duyduğunuz takdirde, lütfen montaj klavuzunda gösterilmiş olan "Malzeme Adını" belirtiniz

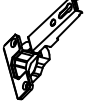

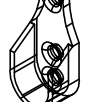
3,5*18 VİDA	ARKALIK KÖŞE	ARKALIK VİDASI	Y. DEVE MENTEŞE	DÜZ MENTEŞE	MENTEŞE ALTLIK	RAF PİMİ	ASKI FLANŞI
							
52 AD	10 AD	16 AD	4 AD	8 AD	12 AD	12 AD	2 AD

