









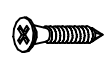

NOT: TAÇ'I 3,5*50
VİDA İLE BAĞLAYINIZ.

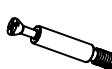
NOT: AYAKLARI 3,5*25 PULLU
VİDA İLE BAĞLAYINIZ.

KULP		1 AD	M4*22 KULP VİDASI		1 AD	3,5*18 VİDA		8 AD	35 LİK RAY		1 TAKIM	MINİFİX MİL		20 AD	MINİFİX GÖVDE		20 AD	KAVALE		20 AD	AYAK		4 AD	KABİN VİDASI		14 AD	3,5*50 VİDA		4 AD	3,5*25 ARKALIK VİDASI(PULLU)		14 AD
------	---	------	-------------------------	---	------	----------------	---	------	---------------	---	---------	----------------	---	-------	------------------	---	-------	--------	---	-------	------	---	------	-----------------	---	-------	----------------	---	------	------------------------------------	--	-------

3,5*25
VIDA

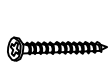
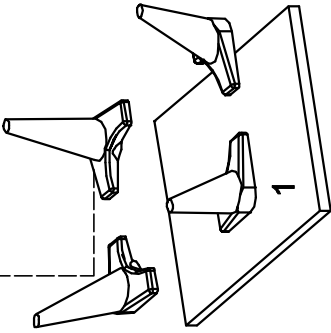
01

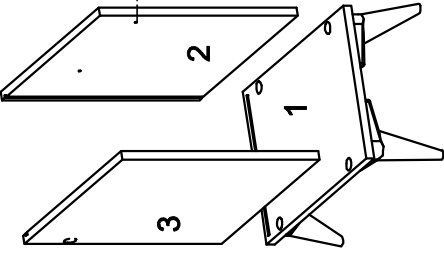

02

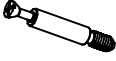
3,5*18
VIDAMINİFIX
MİL VE
GÖVDESİNİ
BAĞLAYINIZ

03

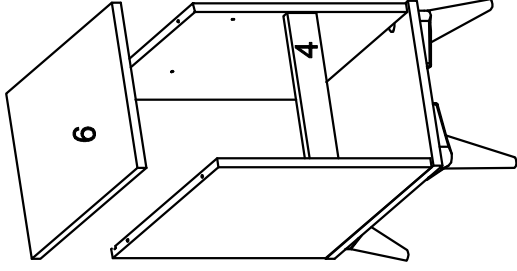

04

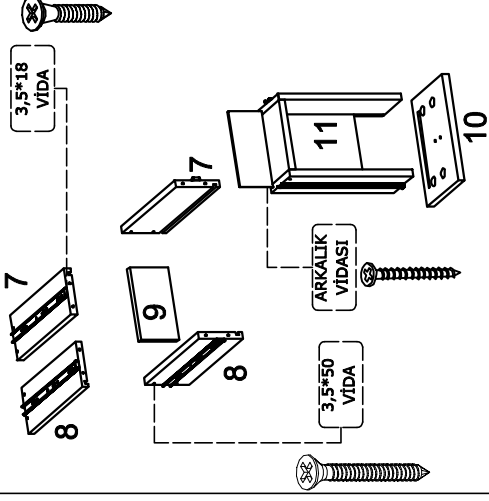
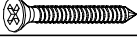
3,5*50
VIDAARKALIK
VIDASI

05

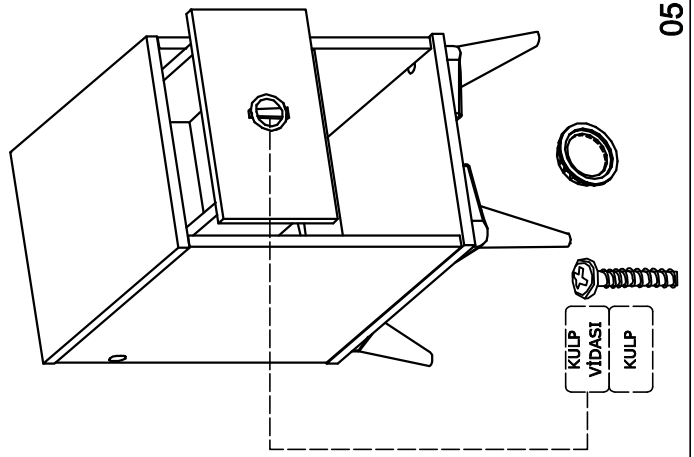

06

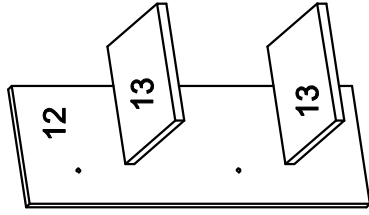
KULP
VIDASI
KULP

07

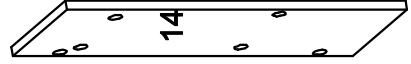

08

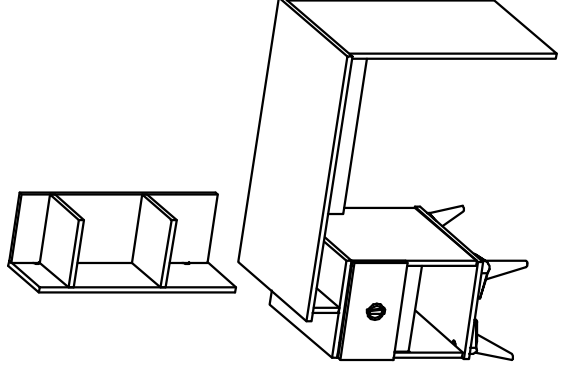

09