

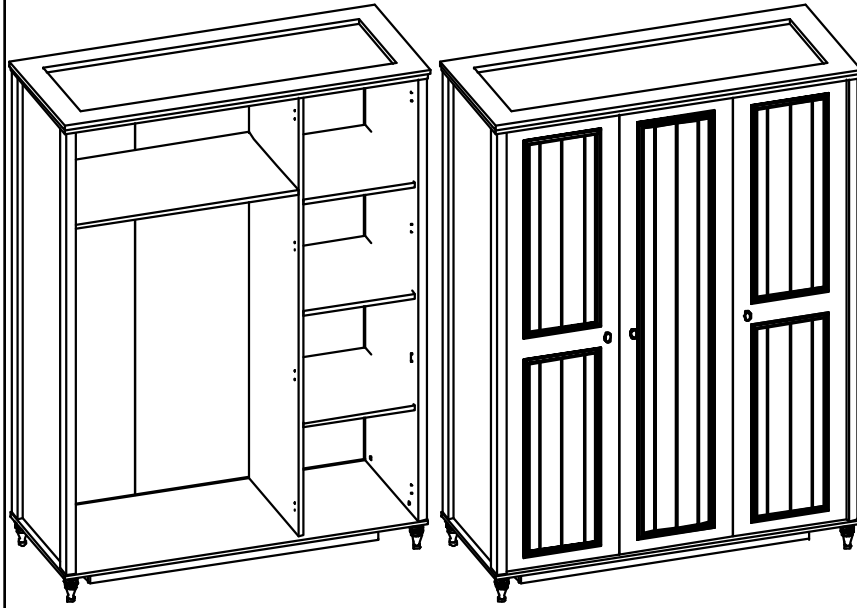

# EZGİ 3 KAPAKLI DOLAP (EZGİ WERDROBE)

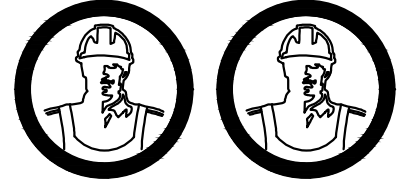







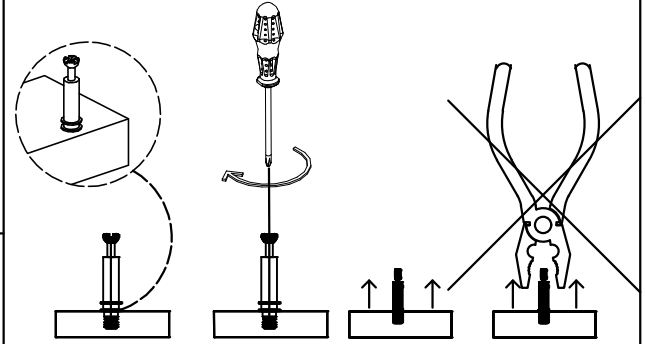

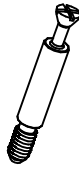
KURULUM 2 KİŞİ İLE  
YAPILMALIDIR.

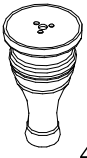
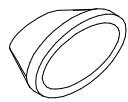
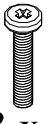
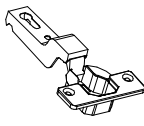
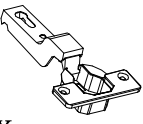
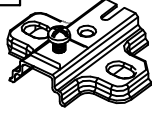

GEREKLİ ARAÇLAR

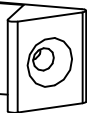
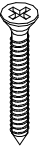

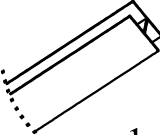
X-01  26 x	X-02  26 x	X-03  12 x	X-04  12 x
X-05  4 x	X-06  4 x	X-07  3 x	X-08  3 x (M4*22)
X-09  8 x	X-10  4 x	X-11  12 x	X-12  16 x
X-13  2 x	X-14  10 x	X-15  28 x (3,5*25)	X-16  66 x (3,5x18)
X-17  1 x	X-18	X-19	X-20

Temizlik ve Bakım Rehberi  
AŞAĞIDA BELİRTİLEN KONULARI DİKKATE  
ALMANIZ ÜRÜNLERİ DAHA UZUN SÜRE  
KULLANMANIZA İMKAN VERECEKTİR.

Mobilyalarınızı herhangi bir sıvıya maruz bırakmayınız.  
Dökülen sıvıları derhal yumuşak ve hafif nemli bir bezle  
siliniz.

Yüzeyde biriken sıvının üzerine kağıt havlu koyunuz ve  
kurumaya bırakınız.

Herhangi bir lekelenmeyi önleyin. Ürünü temizlerken  
kimyasal cam temizleyiciler ve sprey cilaları kullanmaktan  
kaçın.

Mobilyalarınızı doğrudan güneş ışığına maruz  
bırakmayın,

Kalorifer peteği veya klimaya yakın olan mobilyalarınızın  
bulunduğu odayı zaman zaman havalandırınız.

Yoğun güneş ışığı veya aşırı ısıya maruz kalma mobilya  
yüzeyinde solma meydana gelebilir.

Aşırı sıcaklıklar ve nem mobilya yüzeyinin kırılmasına  
veya çatlamasına neden olabilir.

Ahşap kaplamanın üzerine kauçuk veya plastik  
malzemeler koymayın. Uzun süre ürün üzerinde bekleyen  
plastik veya kauçuk içerisindeki kimyasallar, zamanla  
reaksiyon gösterebilir.

Mobilya yüzeyine sıcak nesnelere koymaktan kaçınınız.

Mobilya yüzeyinde biriken tozları nemli ve kuru olmak  
üzere iki ayrı bez ile temizleyiniz.

Mobilya yüzeyine bırakılan zararlı nesnelere uzun süre  
beklediğinde ürüne hasar verebilir.

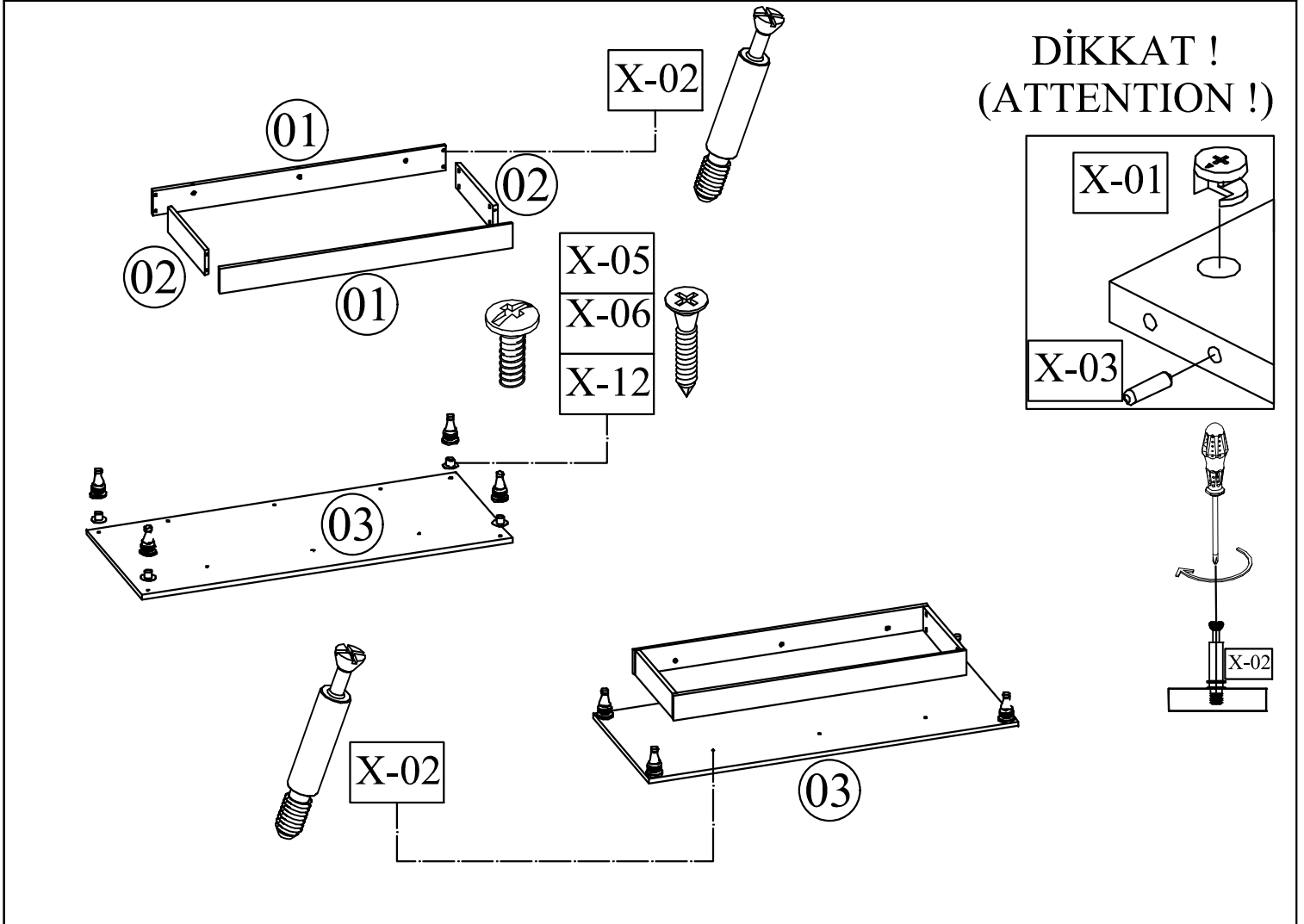
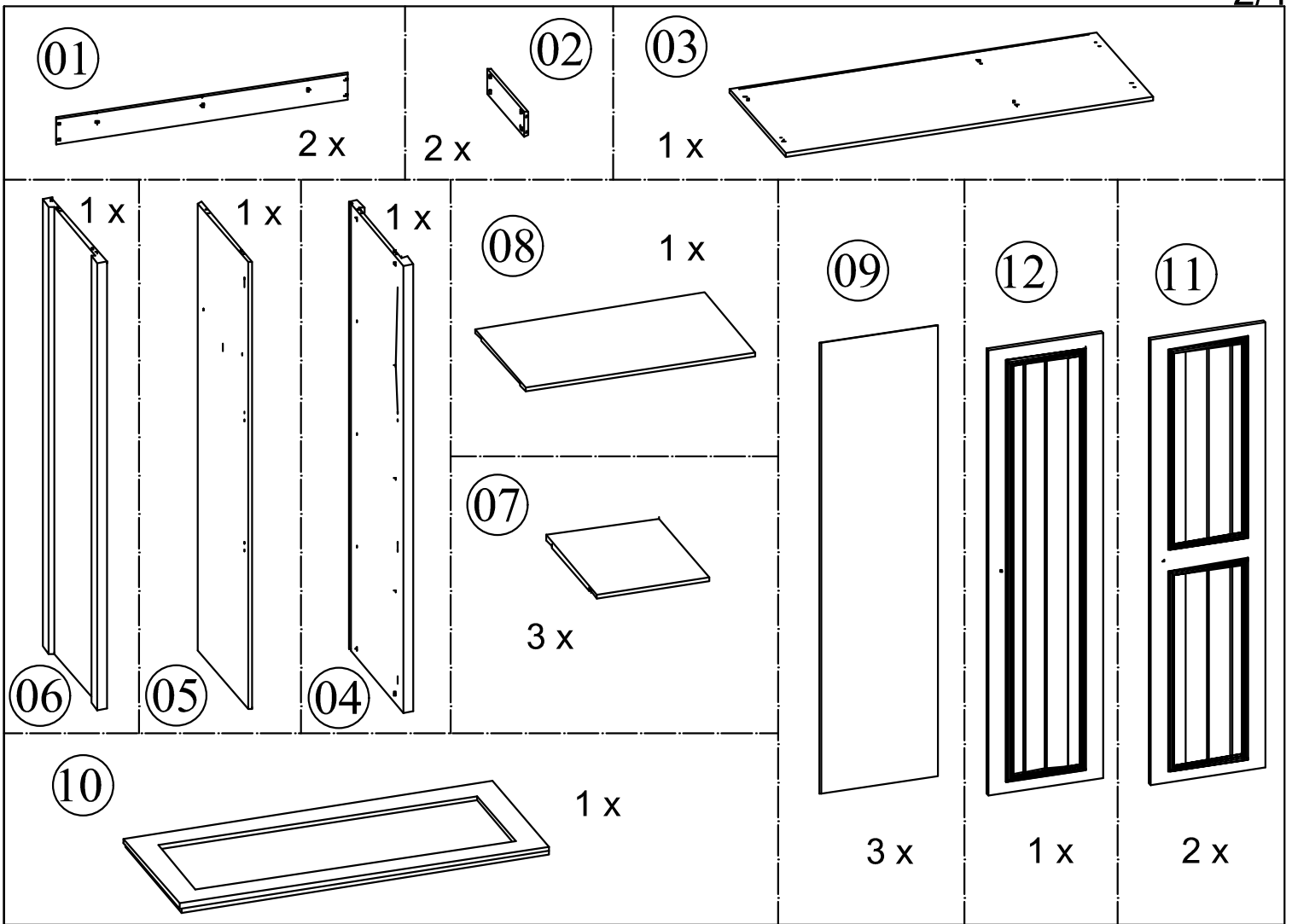

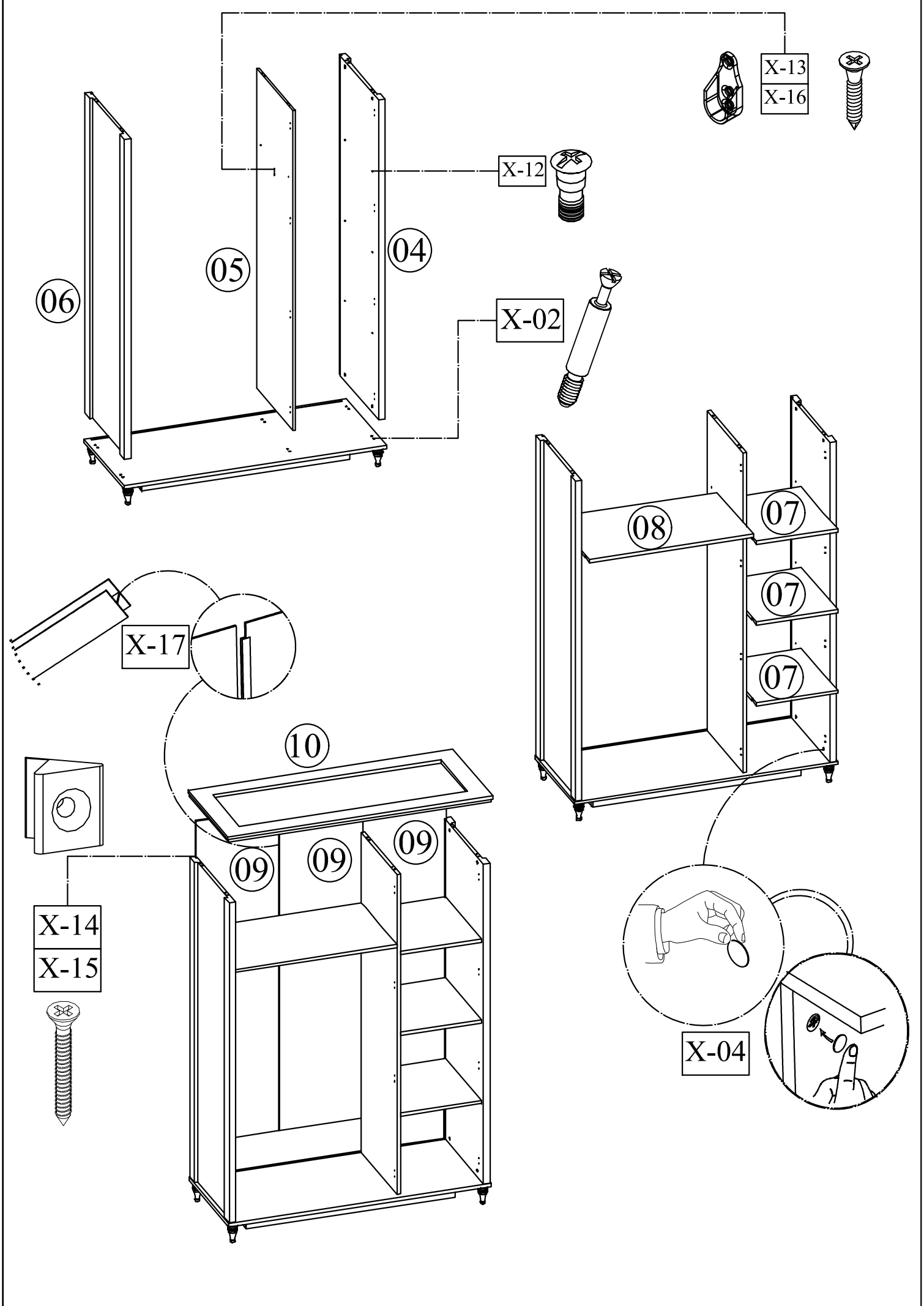

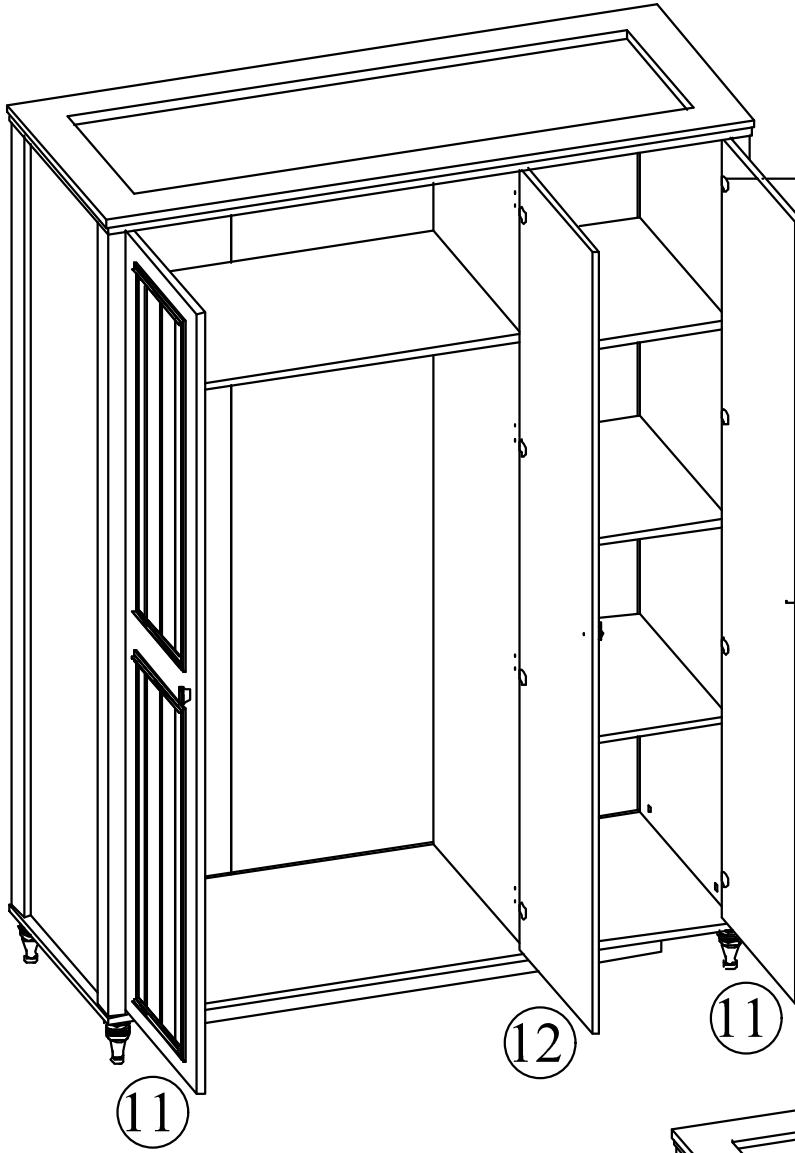

X-09

X-11

X-15

X-16

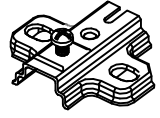
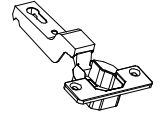
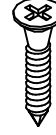

NOT: 3,5\*25 ARKALIK VİDASINI SADECE MENTEŞE TABAN ORTASINDAN BAĞLAYINIZ. HER MENTEŞE İÇİN 1 ADET KULLANILACAKTIR.

X-07

X-08

