

EZGİ ŞİFONYER (EZGİ DRESSER)

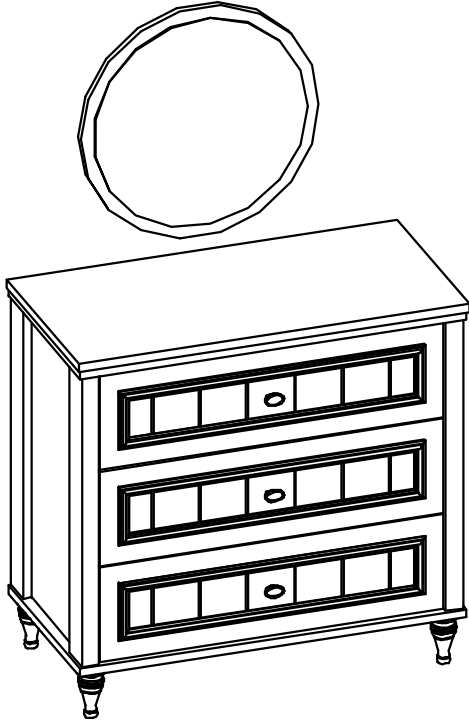





KURULUM 2 KİŞİ İLE
YAPILMALIDIR.

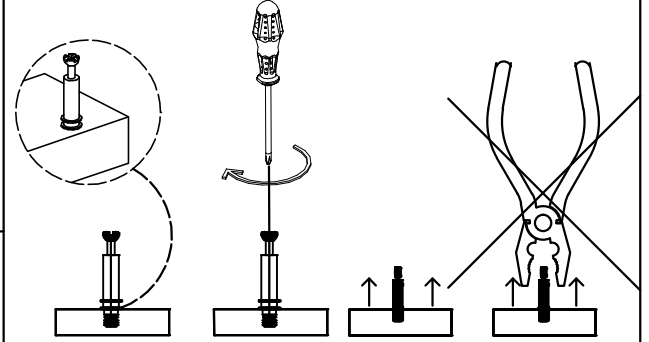

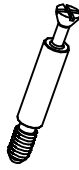
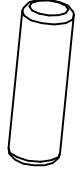
GEREKLİ ARAÇLAR

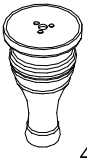
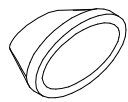
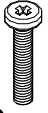
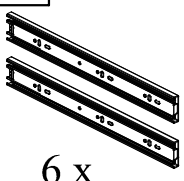

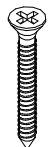
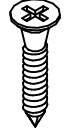
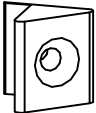
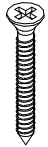
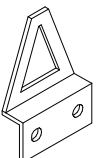
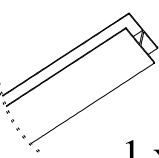
X-01  32 x	X-02  32 x	X-03  8 x	X-04  32 x
X-05  4 x	X-06  4 x	X-07  3 x	X-08  3 x (M4*22)
X-09  6 x	X-10  1 x	X-11  1 x (4*50)	X-12  38 x (3,5x18)
X-13  6 x	X-14  12 x (3,5*25)	X-15  1 x	X-16  1 x
X-17	X-18	X-19	X-20

Temizlik ve Bakım Rehberi

AŞAĞIDA BELİRTİLEN KONULARI DİKKATE
ALMANIZ ÜRÜNLERİ DAHA UZUN SÜRE
KULLANMANIZA İMKAN VERECEKTİR.

Mobilyalarınızı herhangi bir sıvıya maruz bırakmayınız.
Dökülen sıvıları derhal yumuşak ve hafif nemli bir bezle
siliniz.

Yüzeyde biriken sıvının üzerine kağıt havlu koyunuz ve
kurumaya bırakınız.

Herhangi bir lekelenmeyi önleyin. Ürünü temizlerken
kimyasal cam temizleyiciler ve sprey cilaları kullanmaktan
kaçınınız.

Mobilyalarınızı doğrudan güneş ışığına maruz
bırakmayınız,

Kalorifer peteği veya klimaya yakın olan mobilyalarınızın
bulunduğu odayı zaman zaman havalandırınız.

Yoğun güneş ışığı veya aşırı ısıya maruz kalma mobilya
yüzeyinde solma meydana gelebilir.

Aşırı sıcaklıklar ve nem mobilya yüzeyinin kırılmasına
veya çatlamasına neden olabilir.

Ahşap kaplamanın üzerine kauçuk veya plastik
malzemeler koymayınız. Uzun süre ürün üzerinde bekleyen
plastik veya kauçuk içerisindeki kimyasallar, zamanla
reaksiyon gösterebilir.

Mobilya yüzeyine sıcak nesnelere koymaktan kaçınınız.
Mobilya yüzeyinde biriken tozları nemli ve kuru olmak
üzere iki ayrı bez ile temizleyiniz.

Mobilya yüzeyine bırakılan zararlı nesnelere uzun süre
beklediğinde ürüne hasar verebilir.

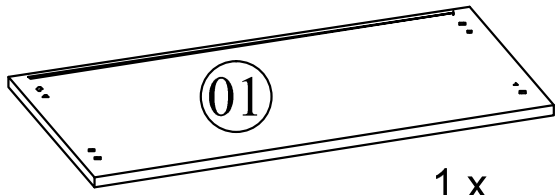

1 x

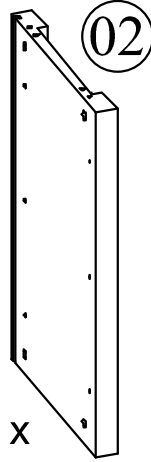

1 x

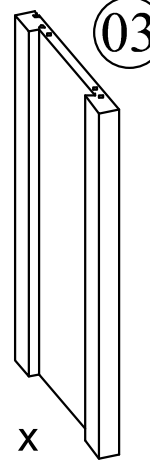

1 x

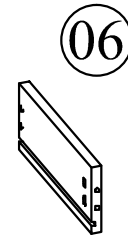

3 x

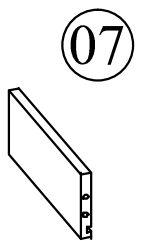

3 x

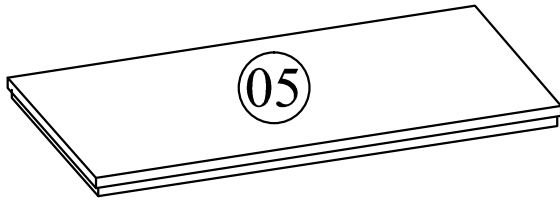

1 x

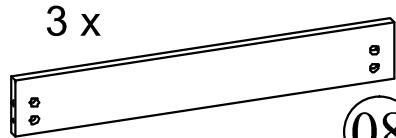

3 x

08

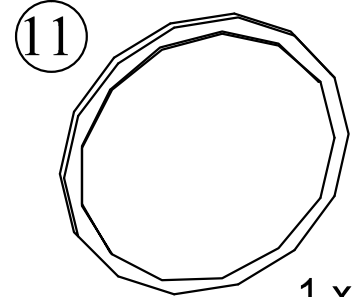

11

1 x

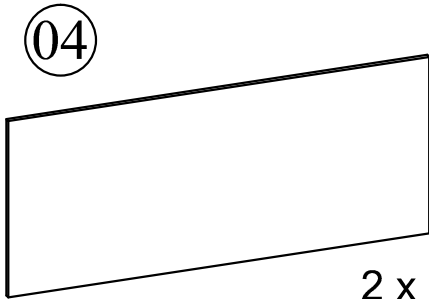

04

2 x

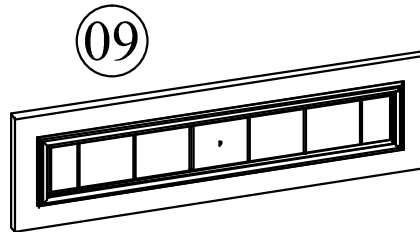

09

3 x

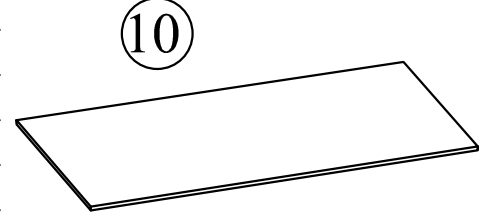

10

3 x

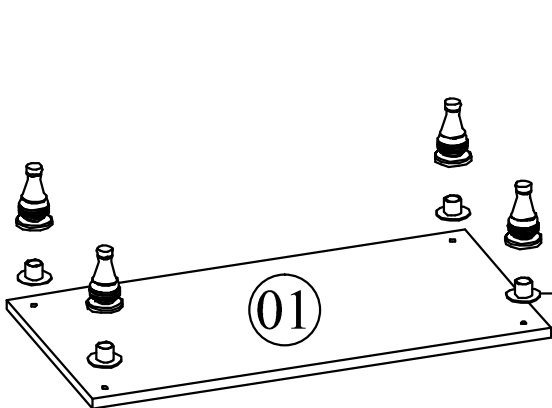

01



X-05

X-06

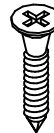

X-12

DİKKAT !
(ATTENTION !)

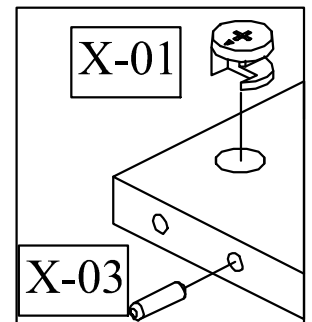

X-01

X-03



03

X-02

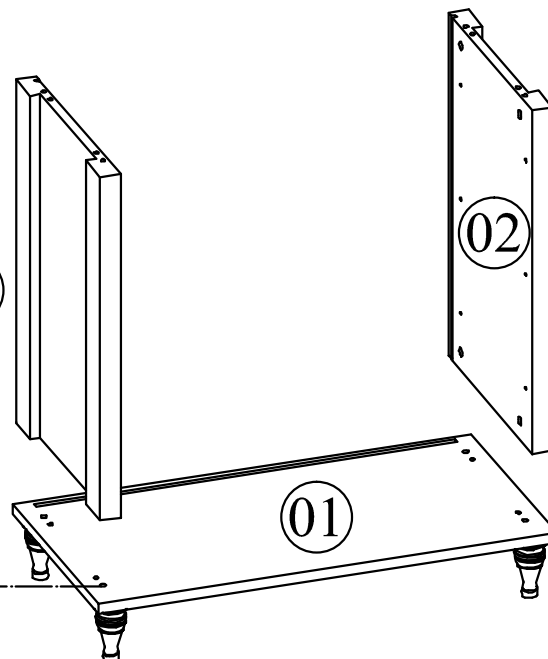

01

02

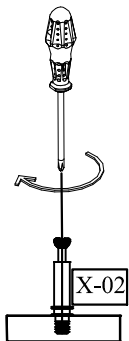

X-02

DİKKAT !
(ATTENTION !)

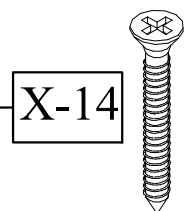
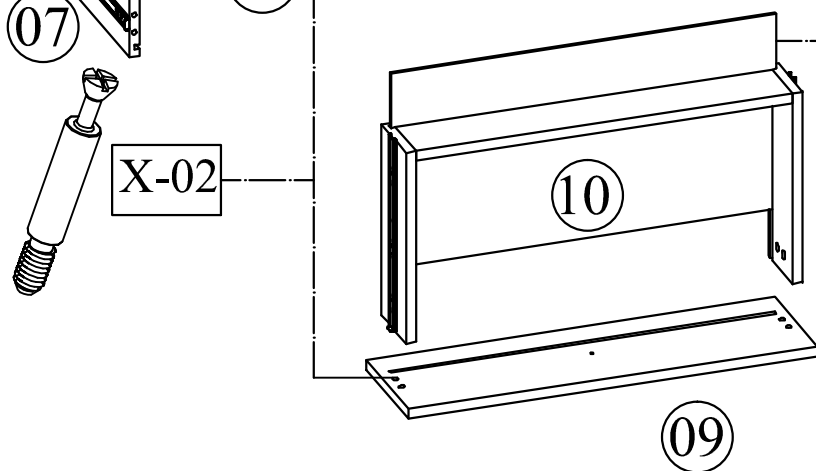
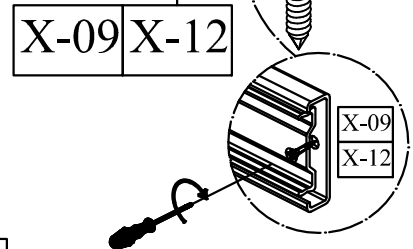
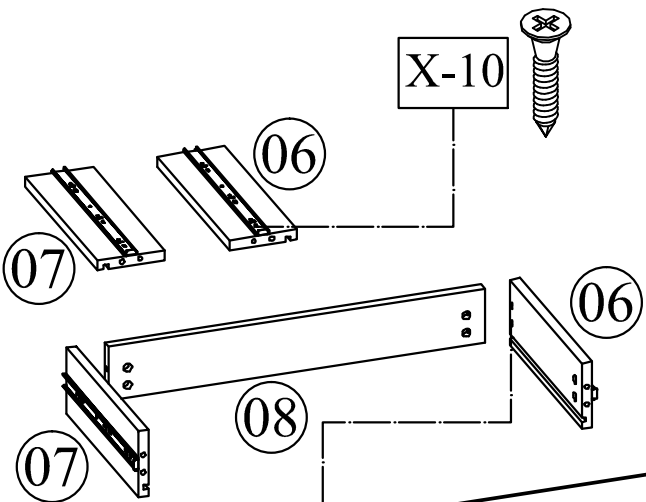
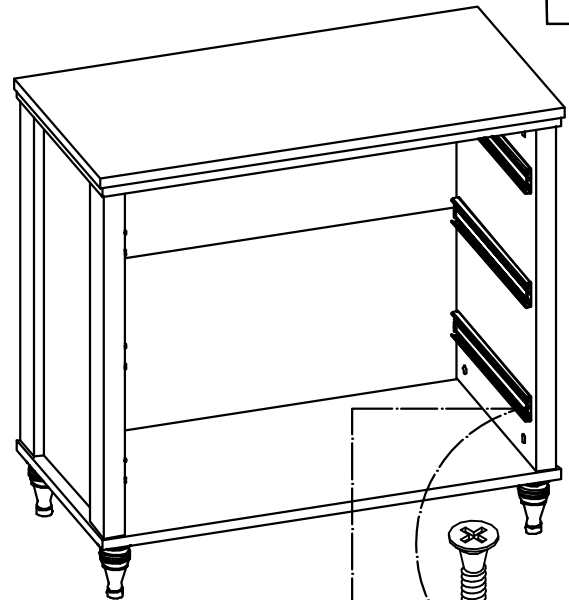
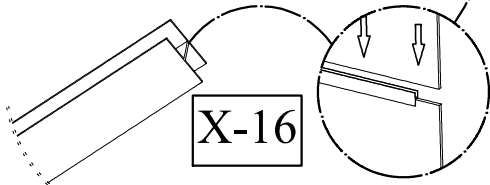
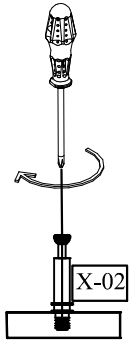
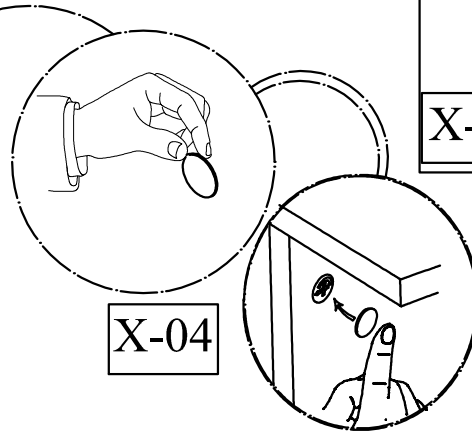
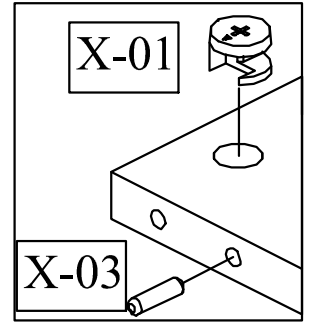
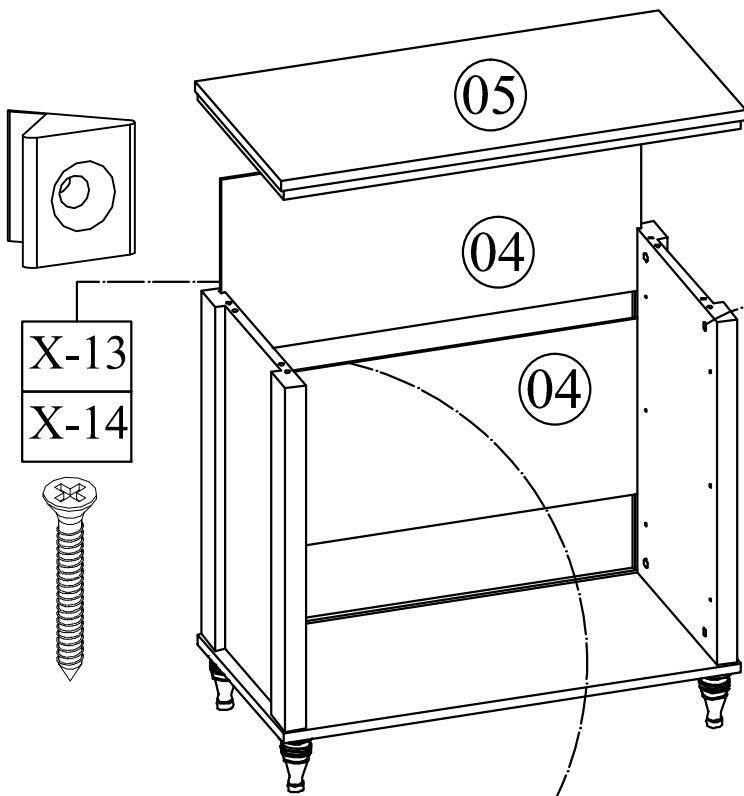

- X-10
- X-11
- X-12
- X-15

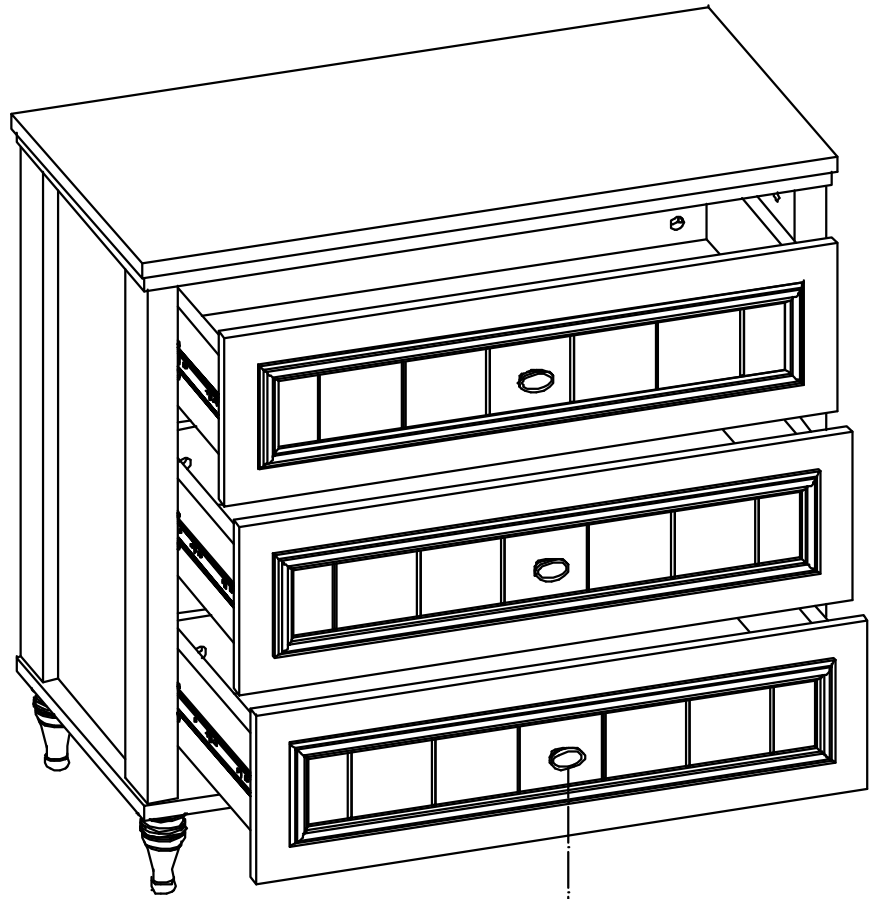
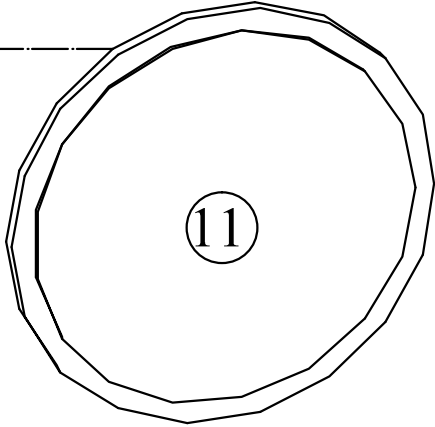
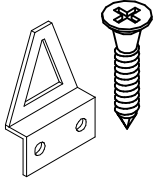
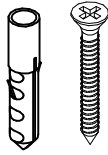

- X-07
- X-08

