4.  
BLOK3.  
BLOK2.  
BLOK1.  
BLOK

KULP	M4*22 KULP VİDASI	KABİN VİDASI	3,5*18 VİDA	DÜZ MENTEŞE	MENTEŞE ALTLIK
4 AD	4 AD	8 AD	32 AD	8 AD	8 AD

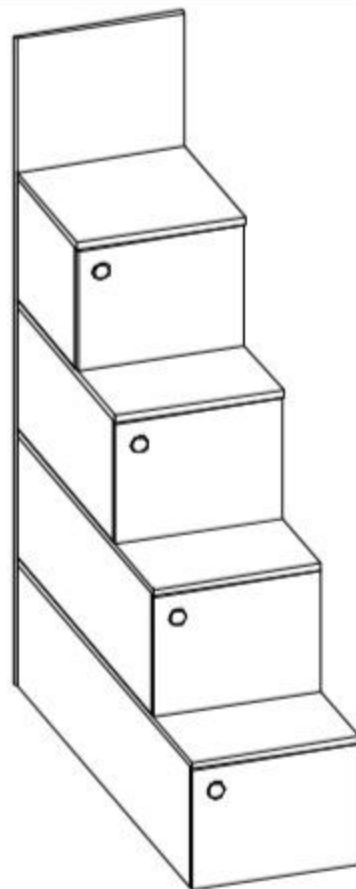

DİĞER BLOKLARI BU  
BLOK GİBİ TOPLAYINIZ !!!

01

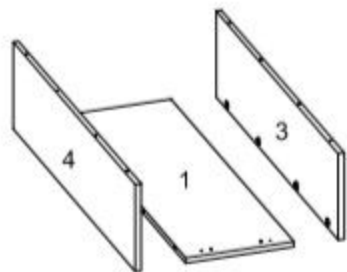
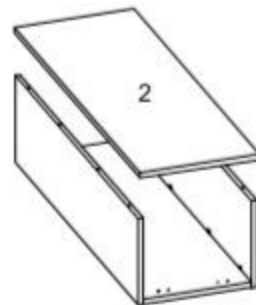

DİĞER BLOKLARI BU  
BLOK GİBİ TOPLAYINIZ !!!

02



03

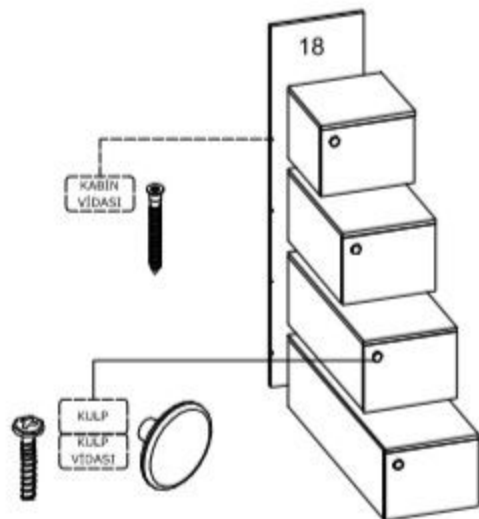

04

BLOKLARI TOPLARKEN  
DETAYA (UZUN OLAN  
TABLANIN ÜSTE  
GELDİĞİNE) DİKKAT  
EDİNİZ.

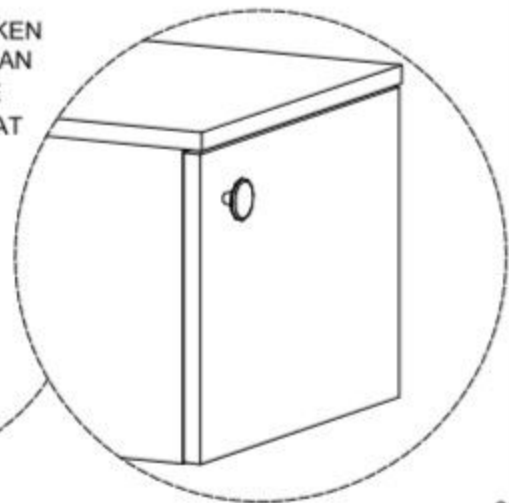

05

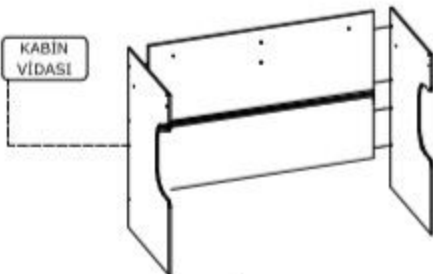

01

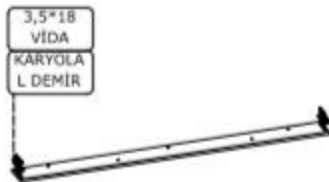

02



03

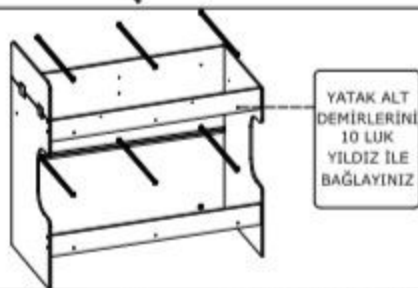

04

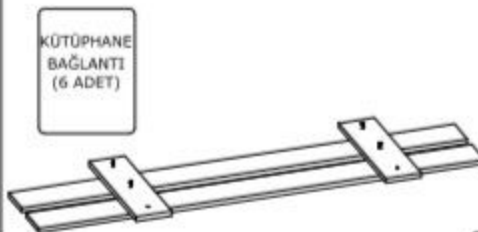

05

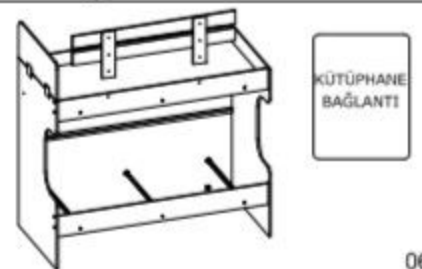

06



07

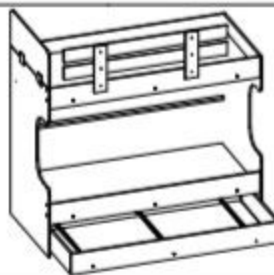

08

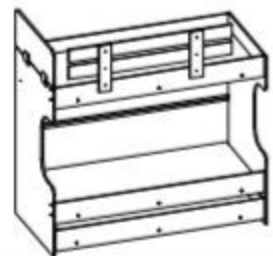







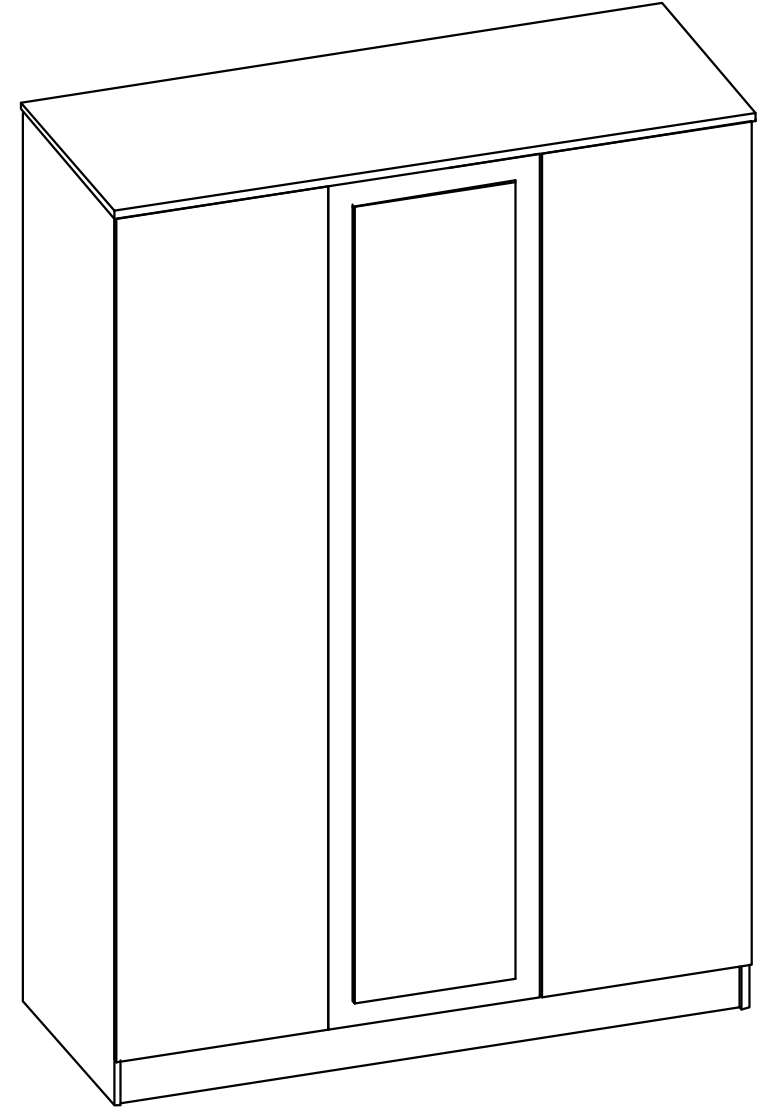
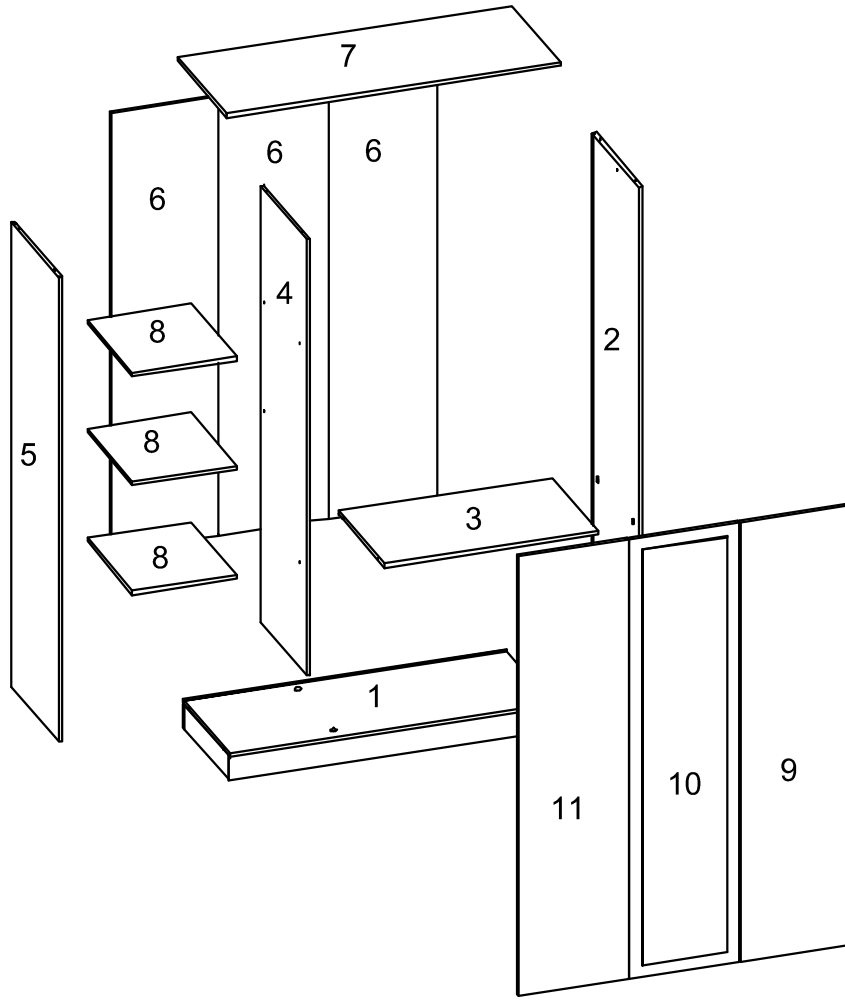

09

KARYOLA L DEMİR	KABİN VİDASI	3,5*18 VİDA	KULP	M4*22 KULP VİDASI	BLUM VİDASI	10 LUK YILDIZ	3,5*25 VİDA
4 AD	16 AD	32 AD	2 AD	2 AD	8 AD	18 AD	8 AD

Yedek parçaya ihtiyaç duyduğunuz  
taktirde, lütfen montaj klavuzunda gösterilmiş  
olan "Malzeme Adını" belirtiniz



3,5*18 VİDA	ARKALIK KÖŞE	ARKALIK VİDASI	Y. DEVE MENTEŞE	DÜZ MENTEŞE	MENTEŞE ALTLIK	RAF PİMİ	ASKI FLANŞI
							
52 AD	10 AD	16 AD	4 AD	8 AD	12 AD	12 AD	2 AD

