

Kablo Merdiveni H 100 **Cable Ladder H 100**

İÇİNDEKİLER **INDEX**

104	Kablo Merdiveni Cable Ladder
105	90° Yatay Dönüş Modülü 90° Horizontal Elbow Module T Dönüş Modülü T Module Dörtlü Bağlantı Modülü + Connection Module
106	İç Bükey Dönüş Modülü 90° Vertical Bend - Inside Dış Bükey Dönüş Modülü 90° Vertical Bend - Outside Ek Elemanı Joint Fitting
107	Seviye Değişirme Elemanı Level Change Unit Separatör Seperator Merdiven Sabitleme Elemanı Ladder Fixing



Pregalvaniz Pre-Galvanized

Kablo Merdiveni H100

Cable Ladder H100

Sipariş Kodu Order Code	Yükseklik Height (H) mm	Genişlik Width (A) mm	Kalınlık Thickness (T) mm	Ağırlık Weight Kg./m.
AFC-100 M 100.15	100	100	1.5	3,309
AFC-100 M 100.20	100	100	2.0	4,355
AFC-100 M 150.15	100	150	1.5	3,400
AFC-100 M 150.20	100	150	2.0	4,446
AFC-100 M 200.15	100	200	1.5	3,502
AFC-100 M 200.20	100	200	2.0	4,548
AFC-100 M 300.15	100	300	1.5	3,695
AFC-100 M 300.20	100	300	2.0	4,741
AFC-100 M 400.15	100	400	1.5	3,891
AFC-100 M 400.20	100	400	2.0	4,937
AFC-100 M 500.15	100	500	1.5	4,080
AFC-100 M 500.20	100	500	2.0	5,127
AFC-100 M 600.15	100	600	1.5	4,273
AFC-100 M 600.20	100	600	2.0	5,319

Örnek Sipariş :

Yükseklik / Height (H) : 100 mm
Genişlik / Width (A) : 100 mm
Kalınlık / Thickness (T) : 1,5 mm
Pregalvaniz / Pre-Galvanized : PG

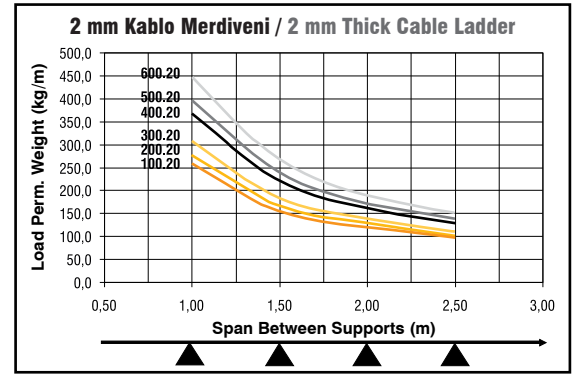
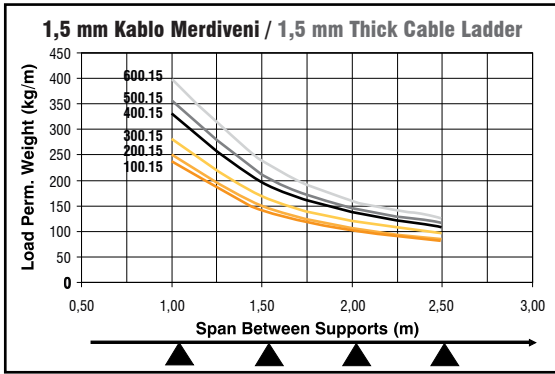
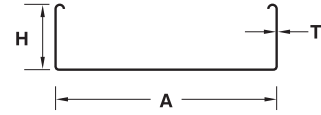
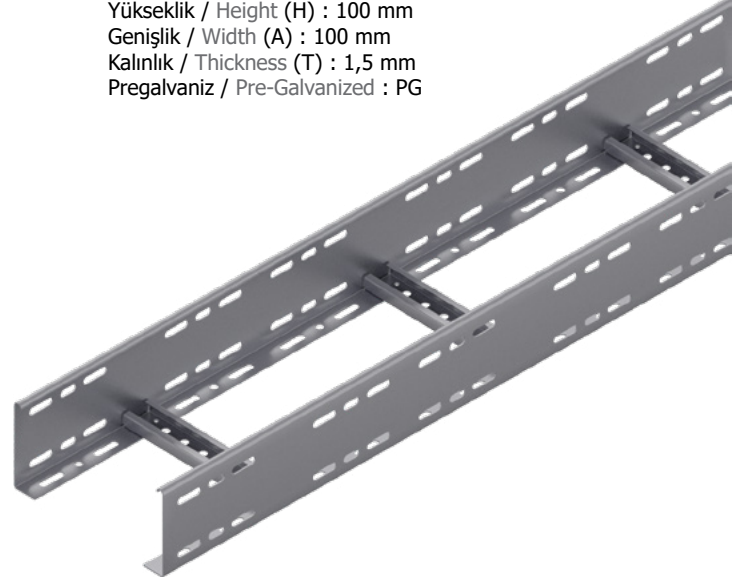

- ▶ Malzeme ağırlıkları yaklaşık değerlerdir, \pm % 10 değişim gösterebilir.
All material weights are approximate and may vary by +/- 10%.

- ▶ Standart uzunluk 2500 ve 3000 mm'dir.
Standard widths are available in 2500, and 3000 mm.

- ▶ Lütfen siparişlerinizde sipariş kodunu bildiriniz.
Please order by product code.

- ▶ Farklı kalınlık ve ölçülerdeki siparişleriniz için lütfen firmamızı arayınız.
Please contact us for your custom orders.

90° Yatay Dönüş Modülü

90° Horizontal Elbow Module

Sipariş Kodu Order Code	Yükseklik Height (H) mm	Genişlik Width (AB) mm	Kalınlık Thickness (T) mm	Ağırlık Weight Kg./Ad.
AFC-100 MK 100.15	100	100	1.5	1,582
AFC-100 MK 150.15	100	150	1.5	1,896
AFC-100 MK 200.15	100	200	1.5	2,110
AFC-100 MK 300.20	100	300	2.0	2,639
AFC-100 MK 400.20	100	400	2.0	3,993
AFC-100 MK 500.20	100	500	2.0	4,633
AFC-100 MK 600.20	100	600	2.0	5,170

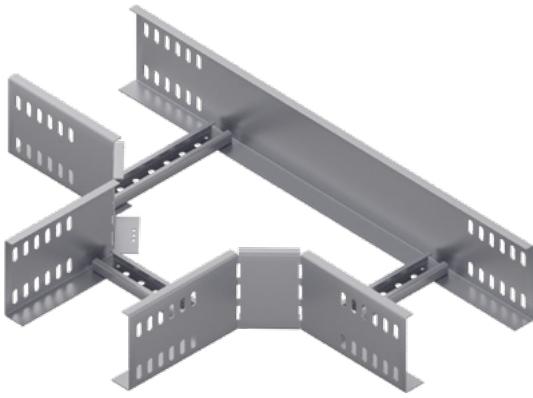
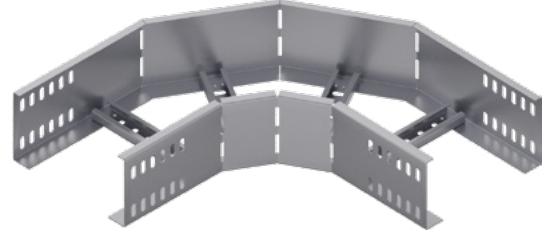

T Dönüş Modülü

T Module

Sipariş Kodu Order Code	Yükseklik Height (H) mm	Genişlik Width (ABC) mm	Kalınlık Thickness (T) mm	Ağırlık Weight Kg./Ad.
AFC-100 MT 100.15	100	100	1.5	2,321
AFC-100 MT 150.15	100	150	1.5	2,606
AFC-100 MT 200.15	100	200	1.5	2,843
AFC-100 MT 300.20	100	300	2.0	3,422
AFC-100 MT 400.20	100	400	2.0	4,787
AFC-100 MT 500.20	100	500	2.0	5,369
AFC-100 MT 600.20	100	600	2.0	5,954

Dörtlü Bağlantı Modülü

+ Connection Module

Sipariş Kodu Order Code	Yükseklik Height (H) mm	Genişlik Width (ABCD) mm	Kalınlık Thickness (T) mm	Ağırlık Weight Kg./Ad.
AFC-100 MD 100.15	100	100	1.5	2,373
AFC-100 MD 150.15	100	150	1.5	2,579
AFC-100 MD 200.15	100	200	1.5	2,729
AFC-100 MD 300.20	100	300	2.0	3,091
AFC-100 MD 400.20	100	400	2.0	4,097
AFC-100 MD 500.20	100	500	2.0	4,453
AFC-100 MD 600.20	100	600	2.0	4,814

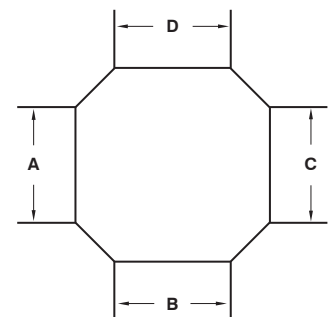
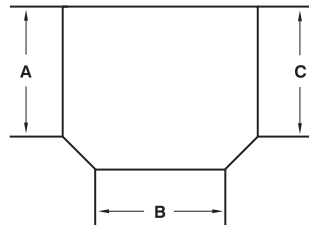
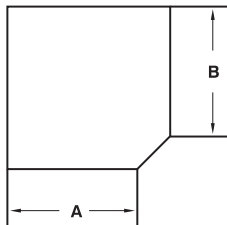
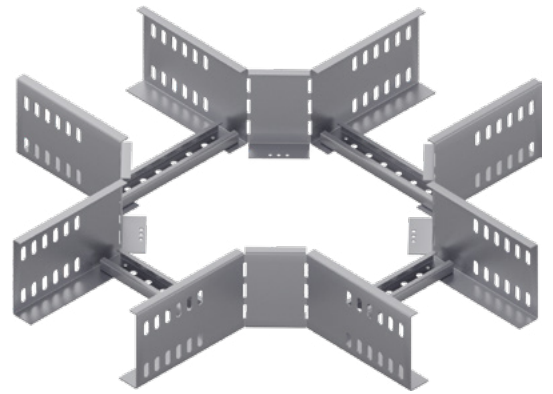



Pregalvaniz Pre-Galvanized

İç Bükey Dönüş Modülü

90° Vertical Bend - Inside

Sipariş Kodu Order Code	Yükseklik Height (H) mm	Genişlik Width (AB) mm	Kalınlık Thickness (T) mm	Ağırlık Weight Kg./Ad.
AFC-100 MİB 100.15	100	100	1.5	2,767
AFC-100 MİB 150.15	100	150	1.5	2,873
AFC-100 MİB 200.15	100	200	1.5	2,947
AFC-100 MİB 300.15	100	300	2.0	3,128
AFC-100 MİB 400.20	100	400	2.0	3,312
AFC-100 MİB 500.20	100	500	2.0	3,488
AFC-100 MİB 600.20	100	600	2.0	3,669

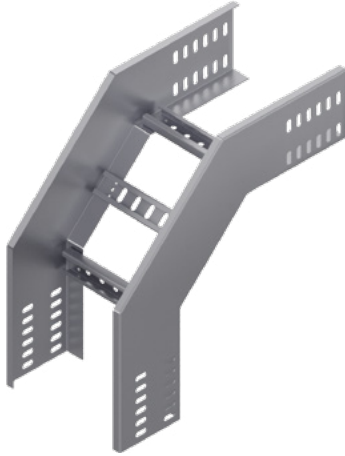
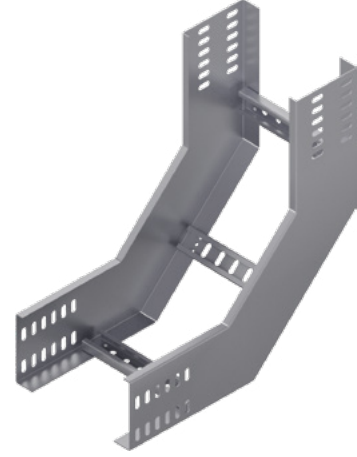

Dış Bükey Dönüş Modülü

90° Vertical Bend - Outside

Sipariş Kodu Order Code	Yükseklik Height (H) mm	Genişlik Width (AB) mm	Kalınlık Thickness (T) mm	Ağırlık Weight Kg./Ad.
AFC-100 MDB 100.15	100	100	1.5	2,767
AFC-100 MDB 150.15	100	150	1.5	2,873
AFC-100 MDB 200.15	100	200	1.5	2,947
AFC-100 MDB 300.15	100	300	2.0	3,128
AFC-100 MDB 400.20	100	400	2.0	3,312
AFC-100 MDB 500.20	100	500	2.0	3,488
AFC-100 MDB 600.20	100	600	2.0	3,669

Ek Elemanı

Joint Fitting

Sipariş Kodu Order Code	Yükseklik Height (H) mm	Genişlik Width (A) mm	Kalınlık Thickness (T) mm	Ağırlık Weight Kg./Ad.
AFC-100 AE 15.20	100	20	2.0	0,219



Seviye Deęiřtirme Elemanı
Level Change Unit

Sipariř Kodu Order Code	Yükseklik Height (H) mm	Geniřlik Width (A) mm	Kalınlık Thickness (T) mm	Aęırlık Weight Kg./Tk.
AFC-100 SD 15.20	75	20	2.0	0,686

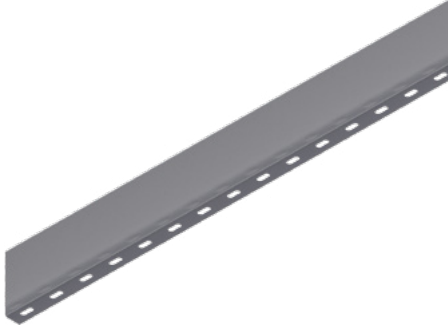

Separatör
Seperator

Sipariř Kodu Order Code	Yükseklik Height (H) mm	Geniřlik Width (A) mm	Kalınlık Thickness (T) mm	Aęırlık Weight Kg./m.
AFC-100 SPM 20.15	100	20	1.5	1,217

Merdiven Sabitleme Elemanı
Ladder Fixing

Sipariř Kodu Order Code	Geniřlik Width (A) mm	Kalınlık Thickness (T) mm	Aęırlık Weight Kg./Ad.
AFC-MKT 25.20	40	2.0	0,033



Kablo Merdiveni H 100 **Cable Ladder H 100**

İÇİNDEKİLER **INDEX**

280

Kablo Merdiveni
Cable Ladder

281

90° Yatay Dönüş Modülü
90° Horizontal Elbow Module
T Dönüş Modülü
T Module
Dörtlü Bağlantı Modülü
+ Connection Module

282

İç Bükey Dönüş Modülü
90° Vertical Bend - Inside
Dış Bükey Dönüş Modülü
90° Vertical Bend - Outside
Ek Elemanı
Joint Fitting

283

Seviye Değiştirme Elemanı
Level Change Unit
Separatör
Seperator
Merdiven Sabitleme Elemanı
Ladder Fixing

Sıcak Daldırma
GHOT Dip Galvanized



Sıcak Daldırma Hot Dip Galvanized

Kablo Merdiveni H100

Cable Ladder H100

Sipariş Kodu Order Code	Yükseklik Height (H) mm	Genişlik Width (A) mm	Kalınlık Thickness (T) mm	Ağırlık Weight Kg./m.
AFC-100 M 100.15	100	100	1.5	3,640
AFC-100 M 100.20	100	100	2.0	4,791
AFC-100 M 150.15	100	150	1.5	3,740
AFC-100 M 150.20	100	150	2.0	4,891
AFC-100 M 200.15	100	200	1.5	3,852
AFC-100 M 200.20	100	200	2.0	5,003
AFC-100 M 300.15	100	300	1.5	4,065
AFC-100 M 300.20	100	300	2.0	5,215
AFC-100 M 400.15	100	400	1.5	4,280
AFC-100 M 400.20	100	400	2.0	5,431
AFC-100 M 500.15	100	500	1.5	4,488
AFC-100 M 500.20	100	500	2.0	5,640
AFC-100 M 600.15	100	600	1.5	4,700
AFC-100 M 600.20	100	600	2.0	5,851

Örnek Sipariş :

Yükseklik / Height (H) : 100 mm
Genişlik / Width (A) : 100 mm
Kalınlık / Thickness (T) : 1,5 mm
Sıcak Daldırma / Hot Dip Galvanized : SD

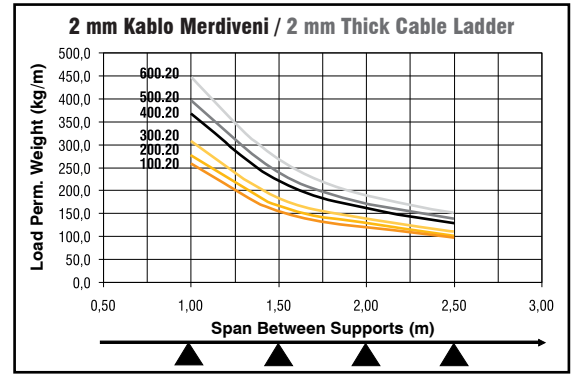
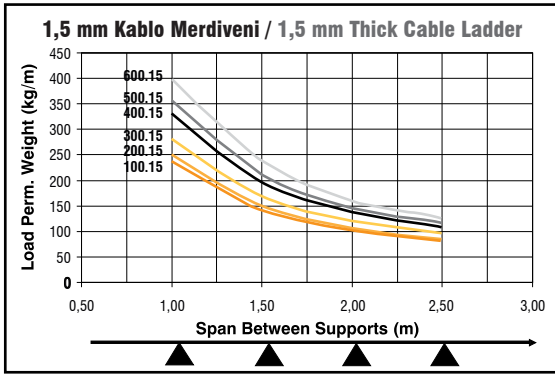
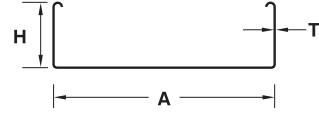
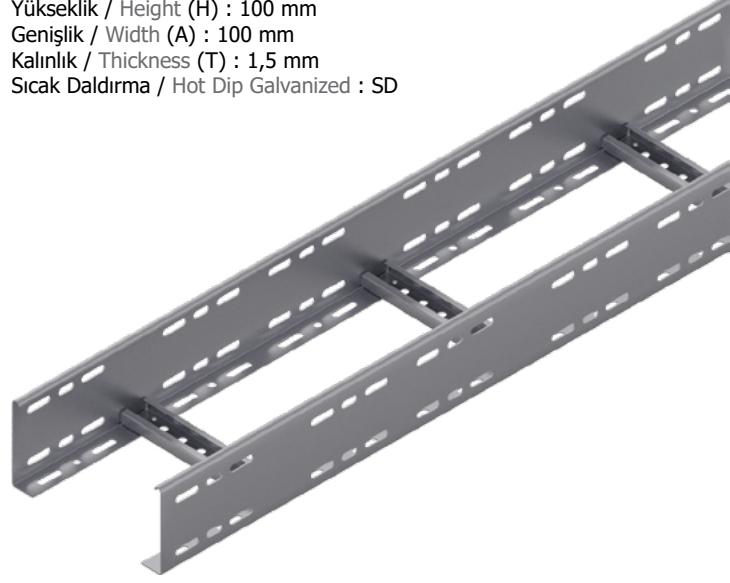

- Malzeme ağırlıkları yaklaşık değerlerdir, \pm % 10 değişim gösterebilir.
All material weights are approximate and may vary by +/- 10%.

- Standart uzunluk 2500 ve 3000 mm'dir.
Standard widths are available in 2500, and 3000 mm.

- Lütfen siparişlerinizde sipariş kodunu bildiriniz.
Please order by product code.

- Farklı kalınlık ve ölçülerdeki siparişleriniz için lütfen firmamızı arayınız.
Please contact us for your custom orders.

90° Yatay Dönüş Modülü

90° Horizontal Elbow Module

Sipariş Kodu Order Code	Yükseklik Height (H) mm	Genişlik Width (AB) mm	Kalınlık Thickness (T) mm	Ağırlık Weight Kg./Ad.
AFC-100 MK 100.15	100	100	1.5	1,740
AFC-100 MK 150.15	100	150	1.5	2,086
AFC-100 MK 200.15	100	200	1.5	2,321
AFC-100 MK 300.20	100	300	2.0	2,903
AFC-100 MK 400.20	100	400	2.0	4,392
AFC-100 MK 500.20	100	500	2.0	5,096
AFC-100 MK 600.20	100	600	2.0	5,687

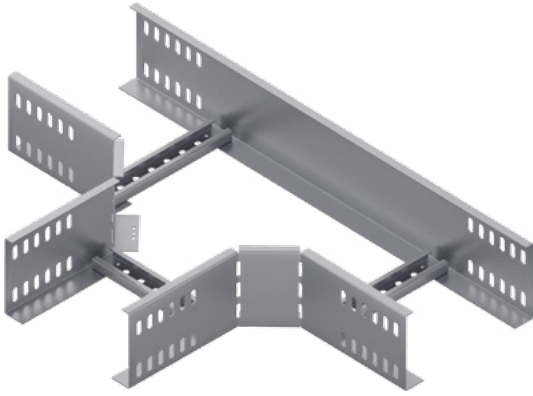
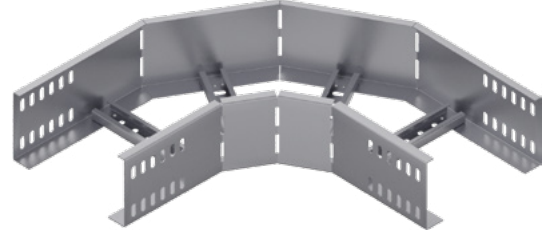

T Dönüş Modülü

T Module

Sipariş Kodu Order Code	Yükseklik Height (H) mm	Genişlik Width (ABC) mm	Kalınlık Thickness (T) mm	Ağırlık Weight Kg./Ad.
AFC-100 MT 100.15	100	100	1.5	2,553
AFC-100 MT 150.15	100	150	1.5	2,867
AFC-100 MT 200.15	100	200	1.5	3,127
AFC-100 MT 300.20	100	300	2.0	3,764
AFC-100 MT 400.20	100	400	2.0	5,266
AFC-100 MT 500.20	100	500	2.0	5,906
AFC-100 MT 600.20	100	600	2.0	6,549

Dörtlü Bağlantı Modülü

+ Connection Module

Sipariş Kodu Order Code	Yükseklik Height (H) mm	Genişlik Width (ABCD) mm	Kalınlık Thickness (T) mm	Ağırlık Weight Kg./Ad.
AFC-100 MD 100.15	100	100	1.5	2,610
AFC-100 MD 150.15	100	150	1.5	2,837
AFC-100 MD 200.15	100	200	1.5	3,002
AFC-100 MD 300.20	100	300	2.0	3,400
AFC-100 MD 400.20	100	400	2.0	4,507
AFC-100 MD 500.20	100	500	2.0	4,898
AFC-100 MD 600.20	100	600	2.0	5,295

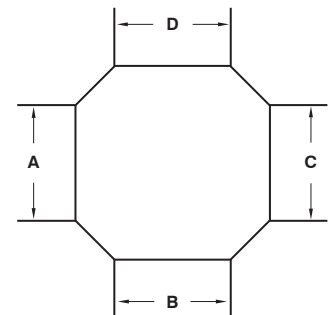
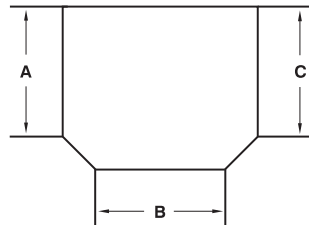
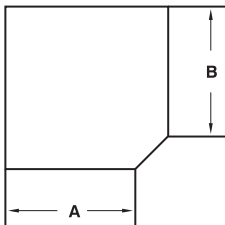
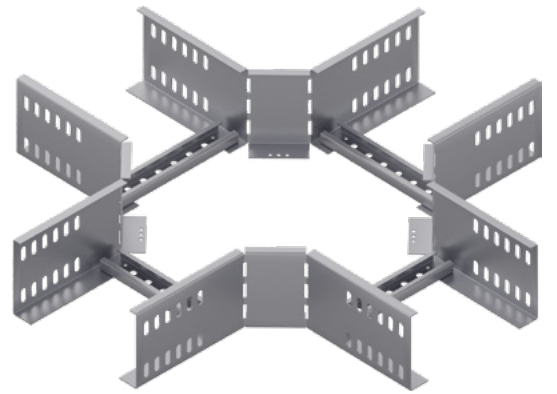



Sıcak Daldırma Hot Dip Galvanized

İç Bükey Dönüş Modülü

90° Vertical Bend - Inside

Sipariş Kodu Order Code	Yükseklik Height (H) mm	Genişlik Width (AB) mm	Kalınlık Thickness (T) mm	Ağırlık Weight Kg./Ad.
AFC-100 MİB 100.15	100	100	1.5	3,044
AFC-100 MİB 150.15	100	150	1.5	3,160
AFC-100 MİB 200.15	100	200	1.5	3,242
AFC-100 MİB 300.15	100	300	2.0	3,441
AFC-100 MİB 400.20	100	400	2.0	3,643
AFC-100 MİB 500.20	100	500	2.0	3,837
AFC-100 MİB 600.20	100	600	2.0	4,036

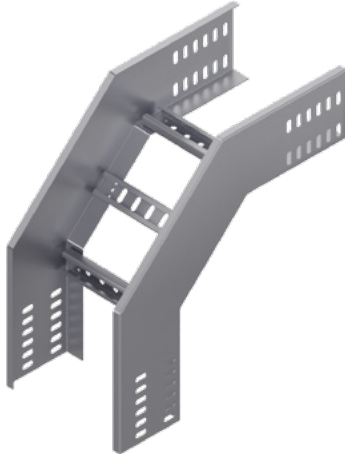

Dış Bükey Dönüş Modülü

90° Vertical Bend - Outside

Sipariş Kodu Order Code	Yükseklik Height (H) mm	Genişlik Width (AB) mm	Kalınlık Thickness (T) mm	Ağırlık Weight Kg./Ad.
AFC-100 MDB 100.15	100	100	1.5	3,044
AFC-100 MDB 150.15	100	150	1.5	3,160
AFC-100 MDB 200.15	100	200	1.5	3,242
AFC-100 MDB 300.15	100	300	2.0	3,441
AFC-100 MDB 400.20	100	400	2.0	3,643
AFC-100 MDB 500.20	100	500	2.0	3,837
AFC-100 MDB 600.20	100	600	2.0	4,036

Ek Elemanı

Joint Fitting

Sipariş Kodu Order Code	Yükseklik Height (H) mm	Genişlik Width (A) mm	Kalınlık Thickness (T) mm	Ağırlık Weight Kg./Ad.
AFC-100 AE 15.20	100	20	2.0	0,241



Seviye Değişirme Elemanı
Level Change Unit

Sipariş Kodu Order Code	Yükseklik Height (H) mm	Genişlik Width (A) mm	Kalınlık Thickness (T) mm	Ağırlık Weight Kg./Tk.
AFC-100 SD 15.20	75	20	2.0	0,754



Separatör
Seperator

Sipariş Kodu Order Code	Yükseklik Height (H) mm	Genişlik Width (A) mm	Kalınlık Thickness (T) mm	Ağırlık Weight Kg./m.
AFC-100 SPM 20.15	100	20	1.5	1,338

Merdiven Sabitleme Elemanı
Ladder Fixing

Sipariş Kodu Order Code	Genişlik Width (A) mm	Kalınlık Thickness (T) mm	Ağırlık Weight Kg./Ad.
AFC-MKT 25.20	40	2.0	0,036

