



ACVATIX™

Electromotoric rotary actuators for butterfly or slipper valves

SAL..

with 90° rotary angle

-
- SAL31.. Operating voltage AC 230 V, 3-position control signal
 - SAL61.. Operating voltage AC/DC 24 V, control signal 0...10 V, 4...20 mA, 0...1000 Ω
 - SAL81.. Operating voltage AC/DC 24 V, 3-position control signal
 - SAL61.. Position feedback, override control
 - For direct mounting on butterfly or slipper valves; no adjustments required
 - Manual adjuster, position indicator and status indication with LED
 - Optional functions with auxiliary switches, potentiometer

Use

For the operation of Siemens butterfly and slipper valves, types VKF41.., VKF46.., and VBF21.. as control or shutoff valves in heating, ventilation and air conditioning systems.

Type summary

| Product no. | Stock no. | Angular rotation | Torque | Operating voltage | Positioning signal | Positioning time | LED | Manual adjuster ¹⁾ | Extra functions |
|----------------------------------|-------------|------------------|--------|-------------------|---|------------------|-----|-------------------------------|-----------------------------------|
| SAL31.00T10 ¹⁾ | S55162-A108 | 90° | 10 Nm | AC 230 V | 3-position | 120 s | - | Push and fix | - |
| SAL31.00T20 ¹⁾ | S55162-A110 | | 20 Nm | | | | | | |
| SAL31.00T40 ¹⁾ | S55162-A111 | | 40 Nm | | | | | | |
| SAL31.03T10 ¹⁾ | S55162-A109 | | 10 Nm | AC/DC 24 V | DC 0...10 V DC 4...20 mA 0...1000 Ω | 30 s | ✓ | | Position feedback, forced control |
| SAL61.00T10 ²⁾ | S55162-A100 | | 10 Nm | | | | | | |
| SAL61.00T20 ²⁾ | S55162-A102 | | 20 Nm | | | | | | |
| SAL61.00T40 ²⁾ | S55162-A103 | | 40 Nm | | | | | | |
| SAL61.03T10 ²⁾ | S55162-A101 | | 10 Nm | | | | | | |
| SAL61.00T20 ²⁾ | S55162-A104 | | 20 Nm | | | | | | |
| SAL81.00T20 ²⁾ | S55162-A106 | | 20 Nm | 3-position | - | 120 s | - | | - |
| SAL81.00T40 ²⁾ | S55162-A107 | 40 Nm | | | | | | | |
| SAL81.03T10 ²⁾ | S55162-A105 | 10 Nm | 30 s | | | | | | |

¹⁾ Approbation: CE

²⁾ Approbation: CE, UL

³⁾ Not designed for continuous operation

Electrical accessories

| Product no. | Auxiliary switch ASC10.51 | Potentiometer ASZ7.5 | Function module AZX61.1 |
|----------------|------------------------------|----------------------|----------------------------|
| Stock no. | S55845-Z103 | S55845-Z106 | S55845-Z107 |
| | Max. 2 in total | | |
| SAL31.. | Max. 2 | Max. 1 | - |
| SAL61.. | Max. 2 | - | Max. 1 AZX61.1 |
| SAL81.. | | Max. 1 | - |

Note: ASZ7.5

For the combination SIMATIC S5/S7 and position feedback message, we recommend actuators with DC 0...9.8 V feedback signals.

The signal peaks that occur in the potentiometer ASZ7.5 may result in error messages on Siemens SIMATIC.

This is not the case when combined with Siemens HVAC controllers.

The reason is that SIMATIC has a higher resolution and faster response time.

Use a 3-wire connection as the voltage divider for the potentiometer.

Powering the potentiometer over the wiper may result in a shorter lifecycle.

Signal peaks occurring in this operating mode increase in frequency and severity throughout its lifecycle.

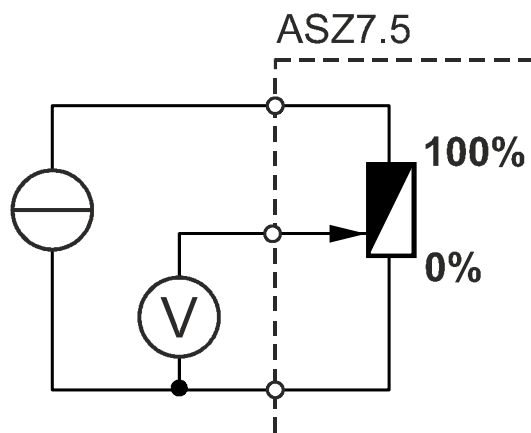

Mechanical accessories

| Product no. | Weather shield ASK39.1 | Mounting set | | | | |
|-----------------|------------------------|--------------------|-------------|---|--------------------|----------------------------------|
| | | ASK31N for VBF21.. | ASK32N | | ASK33N for VKF41.. | ASK35N for VKF45.. ²⁾ |
| | | | VBF21.. | VBI31.. ¹⁾ VCI31.. ¹⁾ VBG31.. ¹⁾ | | |
| Stock no. | S55845-Z109 | S55845-Z100 | S55845-Z211 | | S55845-Z101 | S55845-Z102 |
| SAL..T10 | Max. 1 | DN 65...150 | DN 40...50 | ✓ | ✓ | - |
| SAL..T20 | | - | - | - | - | DN 40...65 |
| SAL..T40 | | - | - | - | - | DN 150...200 |

¹⁾ Types VBI31..., VCI31..., and VBG31.. are available only while stock lasts from 2019 on.

²⁾ Type VKF45.. was replaced by type VKF46.. in the year 2000.

Ordering



Example

| Product no. | Stock no. | Description | Quantity |
|-------------|-------------|-----------------|----------|
| SAL31.00T10 | S55162-A108 | Rotary actuator | 1 |
| ASZ7.5 | S55845-Z106 | Potentiometer | 1 |

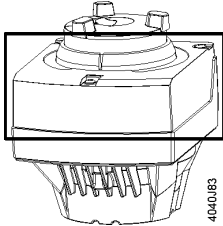

Delivery

Actuators, valves and accessories are supplied in individual packs.

Spare part kit

| | | | |
|-----------------------------------|---|--|--|
| Stock number 8000060844 | Housing cover  |  | |
| | 2 adapters  | | 1 pc. 14 mm 1 pc. 11 mm |
| | 4 screws  | | 2 pcs. M5 x 20 mm 2 pcs. M6 x 20 mm |

Combinations

| SAL.. | | | | | Angular rotation Torque | | | SAL..T10 | SAL..T20 | SAL..T40 |
|--|------------|--------------------------|-----|--|--------------------------|----------------------------|------|----------|---------------|----------|
| | | | | | | | | 10 Nm | 90 ° 20 Nm | 40 Nm |
| Slipper valves | Data Sheet | Valve type ¹⁾ | DN | k _{vs} [m ³ /h] | Mounting set | Δp _{max} [kPa] | | | | |
| PN6  1 °C... 120 °C | N4241 | VBF21.40 | 40 | 25 | ASK32N | 30 | - | - | | |
| | | VBF21.50 | 50 | 40 | | | | | | |
| | | VBF21.65 | 65 | 63 | | | | | | |
| | | VBF21.80 | 80 | 100 | ASK31N | | | | | |
| | | VBF21.100 | 100 | 160 | | | | | | |
| | | VBF21.125 | 125 | 550 | | | | | | |
| | | VBF21.150 | 150 | 820 | | | | | | |
| Butterfly valves | | | | | Δp _s [kPa] | | | | | |
| PN16  -10 °C...120 °C | N4131 | VKF41.40 | 40 | 50 | ASK33N | 500 | - | - | | |
| | | VKF41.50 | 50 | 80 | | | | | | |
| | | VKF41.65 | 65 | 200 | | | | | | |
| | | VKF41.80 | 80 | 400 | | | | | | |
| | | VKF41.100 | 100 | 760 | | | | | | |
| | | VKF41.125 | 125 | 1'000 | | | | | | |
| | | VKF41.150 | 150 | 2'100 | | | | | | |
| | | VKF41.200 | 200 | 4'000 | | | | | | |
| PN16  -10 °C....120 °C | N4136 | VKF46.40 | 40 | 50 | - | - | 1600 | - | | |
| | | VKF46.50 | 50 | 85 | | | | | | |
| | | VKF46.65 | 65 | 215 | | | | | | |
| | | VKF46.80 | 80 | 420 | | | | | | |
| | | VKF46.100 | 100 | 800 | | | | | | |
| | | VKF46.125 | 125 | 1010 | | | | | | |

Product documentation

Detailed information about the New Generation actuators can be found in the basic documentation "Electromotoric actuators SAX..., SAL.." (CE1P4040en).

This document describes the characteristics of valve and actuator combinations, it describes the DIL Switch function:

A6V12050595 Valve Actuator DIL Switch Characteristic Overview

Related documents such as environmental declarations, CE declarations, etc., can be downloaded at the following Internet address:

<http://siemens.com/bt/download>

Notes

Engineering

SAL 31.. / SAL81..

3-position actuators must have their own specific controller, refer to "Connection Diagrams" (page 10).

SAL61..

Up to 10 actuators can drive in parallel on a controller output with a rating of 1 mA. Modulating actuators have an input impedance of 100 kΩ.

Mounting

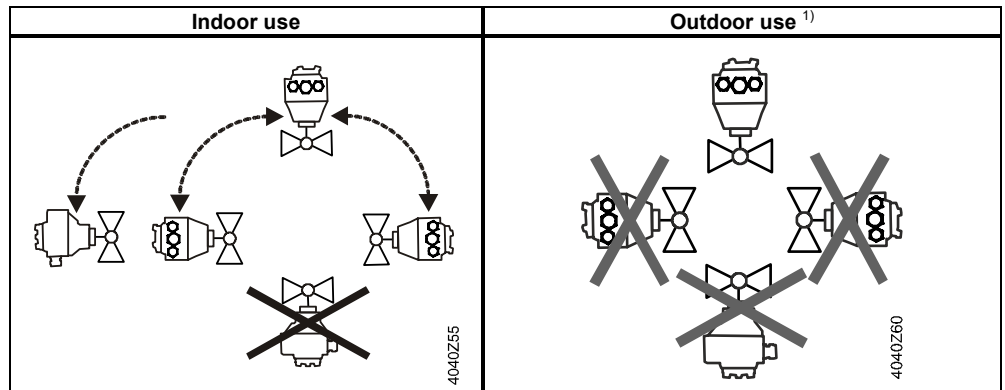

¹⁾ Only in connection with weather shield ASK39.1

Maintenance

The rotary actuators are maintenance-free.

Disposal



The device is considered electrical and electronic equipment for disposal in terms of the applicable European Directive and may not be disposed of as domestic garbage.

- Dispose of the device through channels provided for this purpose.
- Comply with all local and currently applicable laws and regulations.

Warranty

The engineering data specified in chapter "Combinations" (page 4) are only guaranteed in connection with the Siemens valves listed.

Note

When using the actuators in connection with slipper valves of other manufacture, correct functioning must be ensured by the user, and Siemens will assume no responsibility. The use of the rotary actuators SAL..T10 with butterfly valves is only permitted for the Siemens Series VKF41..

Technical Data

| | | SAL.. |
|-------------------------|--|--|
| Power supply | Operating voltage SAL31.. SAL61.. SAL81.. | AC 230 V ±15% AC 24 V ± 20% / DC 24 V + 20% / -15% (SELV) AC 24 V ±20% / DC 24 V + 20 % / -15% (SELV) |
| | Frequency | 45...65 Hz |
| | External supply line protection (EU) | <ul style="list-style-type: none"> • Fuse slow 6...10 A • Circuit breaker max. 13 A, Characteristic B, C, D according to EN 60898 • Power source with current limitation of max. 10 A |
| | Power consumption at 50 Hz SAL31.00T10 Rotary actuator turns SAL31.00T20 Rotary actuator turns SAL31.00T40 Rotary actuator turns SAL31.03T10 Rotary actuator turns SAL61.00T10 Rotary actuator turns SAL61.00T20 Rotary actuator turns SAL61.00T40 Rotary actuator turns SAL61.03T10 Rotary actuator turns SAL81.00T10 Rotary actuator turns SAL81.00T20 Rotary actuator turns SAL81.00T40 Rotary actuator turns SAL81.03T10 Rotary actuator turns | 3.5 VA / 2 W 4.5 VA / 2.75 W 7 VA / 4 W 5,5 VA / 3.25 W 5 VA / 2.5 W 6 VA / 2.75 W 9 VA / 4 W 7.5 VA / 3.5 W 3 VA / 2 W 4 VA / 2.75 W 6 VA / 3.75 W 5 VA / 3.5 W |
| Function data | Positioning times (with spec. nominal angular rotation) SAL31.00., SAL61.00., SAL81.00 SAL31.03T10, SAL61.03T10 SAL81.03T10 | 120 s 30 s |
| | Torque SAL...T10 SAL...T20 SAL...T40 | 10 Nm running / min. 4 Nm holding 20 Nm running / min. 14 Nm holding 40 Nm running / min. 14 Nm holding |
| | Rotary angle | 90° |
| | Permissible medium temperature (valve fitted) | -10...120 °C |
| Signal inputs | Positioning signal "Y" SAL31.., SAL81.. SAL31.. Voltage SAL81.. Voltage SAL61.. (DC 0...10 V) Current draw Input impedance SAL61.. (DC 4...20 mA) Current draw Input impedance | 3-position AC 230 V ±15% AC 24 V ± 20 % / DC 24 V + 20 % / -15% ≤ 0.1 mA ≥100 kΩ DC 4...20 mA ± 1% ≤500 Ω |
| | Parallel operation | SAL61.. ≤ 10 (depending on controller output) |
| Forced control | Positioning signal "Z" SAL61.. R = 0...1000 Z connected to G Z connected to G0 Voltage Current draw | R = 0...1000 Ω, G, G0 Stroke / rotation proportional to R 90° ¹⁾ 0° ¹⁾ Max. AC 24 V ± 20% Max. DC 24 V + 20% / -15% ≤ 0.1 mA |
| | Position feedback | Position feedback U SAL61.. Load impedance Load |
| Connecting cable | Wire cross-sectional areas | 0.75...1.5 mm ² , AWG 20...16 ²⁾ |
| Connecting cable | Cable entries | 2 entries Ø 20.5 mm (for M20) 1 entry Ø 25.5 mm (for M25) |

| | | |
|------------------------------------|--|---|
| Degree of protection | Housing from vertical to horizontal | IP54 as per EN 60529 ³⁾ |
| | Insulation class SAL31.. AC 230 V SAL61.. AC / DC 24 V SAL81.. AC / DC 24 V | As per EN 60730 II III III |
| Environmental conditions | Operation Climatic conditions Mounting location Temperature Humidity (noncondensing) | IEC 60721-3-3 Class 3K5 Indoors (weather-protected) -15...55 °C 5...95 % r.h. |
| | Transport Climatic conditions Temperature Humidity | IEC 60721-3-2 Class 2K3 -25...70 °C <95 % r.h. |
| | Storage Climatic conditions Temperature Humidity | IEC 60721-3-1 Class1K3 -15...55 °C 5...95 % r.h. |
| | Max. media temperature when mounted on valve | 120 °C |
| Norms and Directives | Product standard | EN 60730-x |
| | Electromagnetic compatibility (Application) | For residential, commercial and industrial environments |
| | EU Conformity (CE) | CE1T4502X1 ⁴⁾ |
| | RCM Conformity | A5W00002575 ⁴⁾ |
| | EAC Conformity | Eurasia Conformity for all SAL.. |
| | UL, cUL AC 230 V AC / DC 24 V | - UL 873 http://ul.com/database . File number E35198 |
| Environmental compatibility | | The product environmental declaration CE1E4502en ⁴⁾ contains data on environmentally compatible product design and assessments (RoHS compliance, materials composition, packaging, environmental benefit, disposal). |
| Dimensions | - | See "Dimensions" (page 11) |
| Weight | Excl. packaging | See "Dimensions" (page 11) |

¹⁾ Observe acting direction of DIL switches

²⁾ AWG = American wire gauge

³⁾ Also with weather shield ASK39.1

⁴⁾ The documents can be downloaded from <http://siemens.com/bt/download>.

| | | |
|----------------------------------|---|--|
| Accessories ¹⁾ | Potentiometer ASZ7.5 | Voltage DC 10 V Current rating <4 mA |
| | Auxiliary switch ASC10.51 External supply line protection US installation, UL & cUL | Switching capacity AC 24...230 V, 6 (2) A, floating See section power supply AC 24 V class 2, 5 A general purpose |

¹⁾ UL recognized component



Connection Diagrams

Internal Diagrams

SAL31..

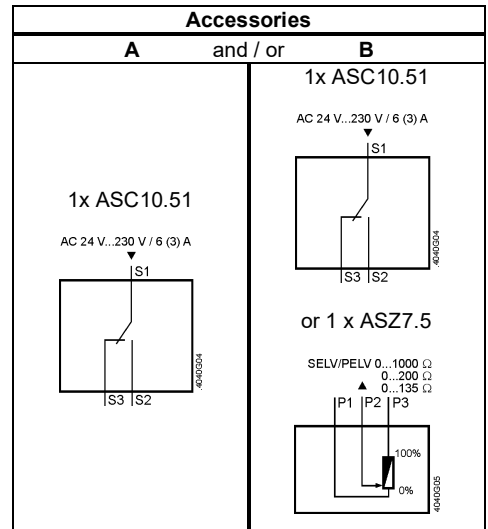
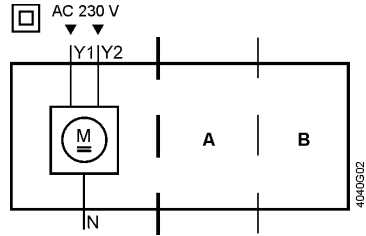

SAL61..

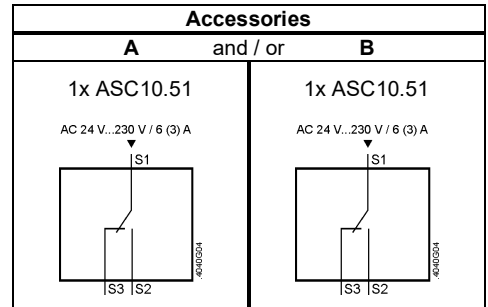
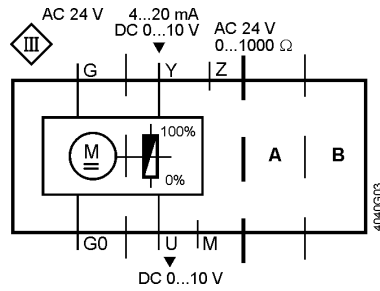

SAL81..

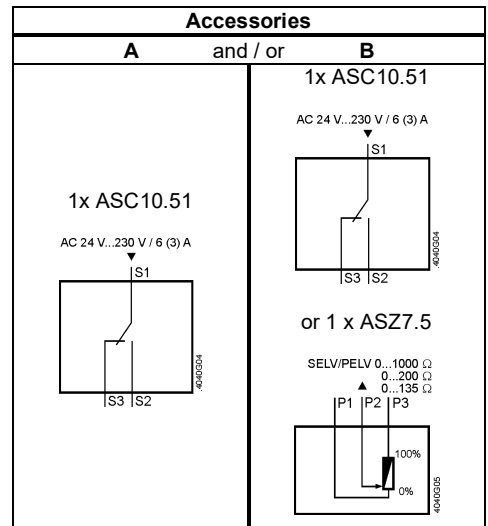
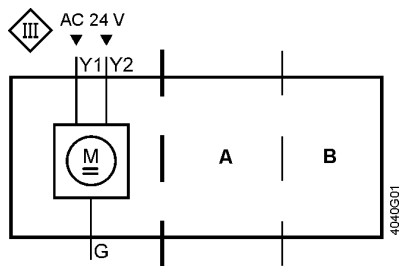

Connection terminals

SAL31..

AC 230 V, 3-position

| | |
|----|---|
| N | System neutral (SN) |
| Y1 | Positioning signal (actuator's spindle turns clockwise) |
| Y2 | Positioning signal (actuator's spindle turns counter-clockwise) |

SAL61..

AC/DC 24 V, DC 0...10 V / 4...20 mA / 0...1000 Ω

| | |
|----|--|
| G0 | System neutral (SN) |
| G | System potential (SP) |
| Y | Positioning signal for DC 0...10 V / 4...20 mA |
| M | Measuring neutral |
| U | Position feedback DC 0...10 V – (reference potential is M measuring neutral) |
| Z | Positioning signal forced control AC/DC ≤ 24 V, 0...1000 Ω |

SAL81..

AC/DC 24 V, 3-position

| | |
|----|---|
| G | System potential (SP) |
| Y1 | Positioning signal (actuator's spindle turns clockwise) |
| Y2 | Positioning signal (actuator's spindle turns counter-clockwise) |

Connection terminals accessories

Auxiliary switch
ASC10.51

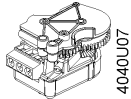

Adjustable switching points, AC 24...230 V

| | |
|---|--|
| 1 | System potential (SP) |
| 2 | Closing (actuator's spindle turns clockwise) |
| 3 | Opening (actuator's spindle turns clockwise) |

AC 24 V...230 V / 6 (3) A

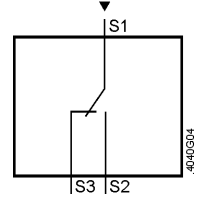

Potentiometer
ASZ7.5/..

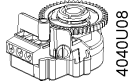

Adjustment of zero point, DC 10 V

| | |
|---|-------------------|
| 1 | Measuring neutral |
| 2 | 0...x Ω |
| 3 | x...0 Ω |

x = 135 Ω, 200 Ω; 1000 Ω

SELV/PELV 0...1000 Ω
0...200 Ω
0...135 Ω

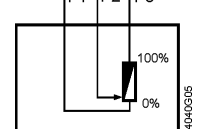

Connection Diagrams

SAL31..

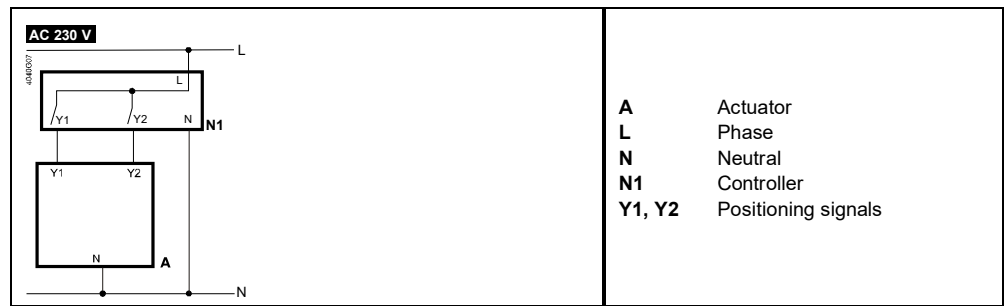

SAL61..

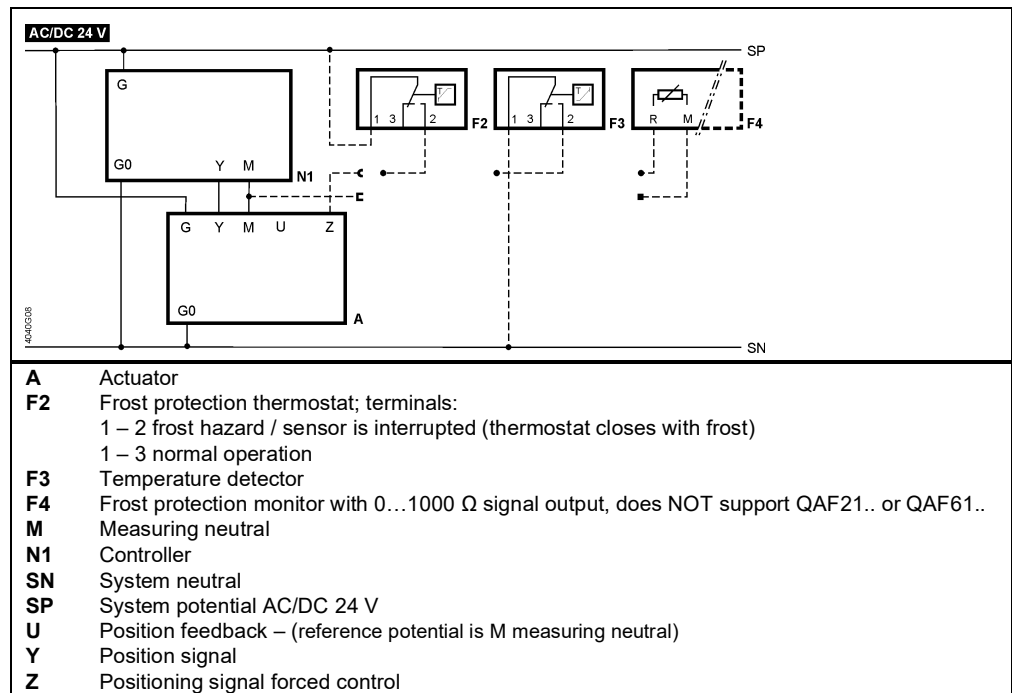

SAL81..

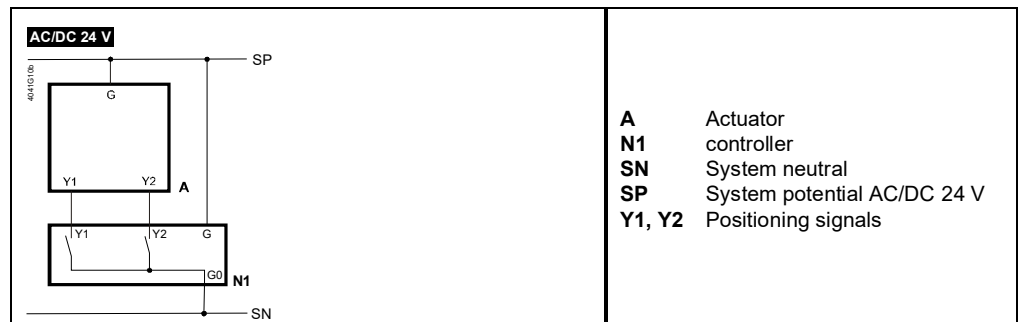

Dimensions

Dimensions in mm

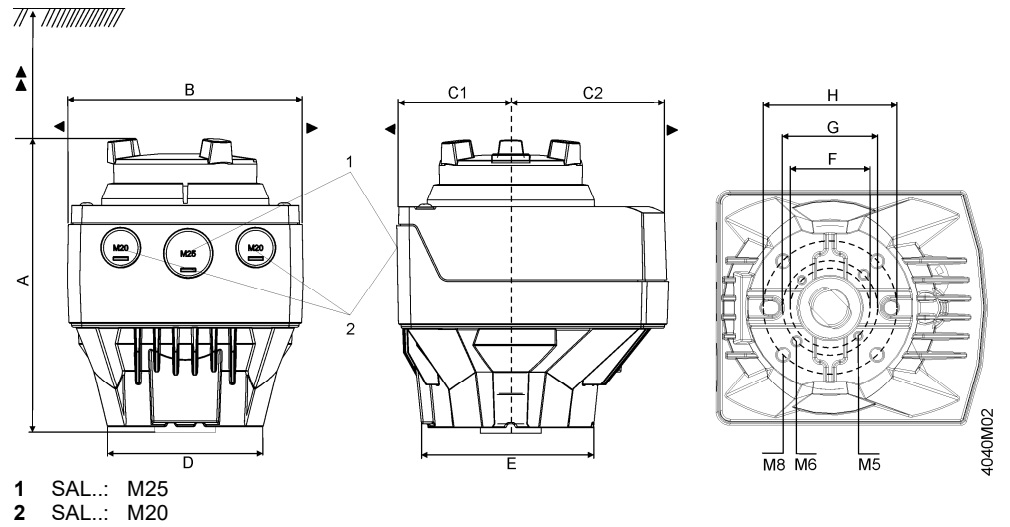

| Type | A | B | C | C1 | C2 | D | E | F | G | H | ▶ | ▶▶ | kg | | |
|--------------|-----|-----|-----|-----|-----|----|----|----|----|----|-----|-----|----------|----------|----------|
| | | | | | | | | | | | | | SAL..T10 | SAL..T20 | SAL..T40 |
| SAL.. | 160 | 124 | 150 | 68 | 82 | 82 | 88 | 42 | 50 | 70 | 100 | 200 | 1.475 | 1.600 | 1.625 |
| With ASK39.1 | +25 | 154 | 300 | 200 | 100 | - | - | - | - | - | - | - | 1.710 | 1.835 | 1.860 |

With mounting set
ASK3..N

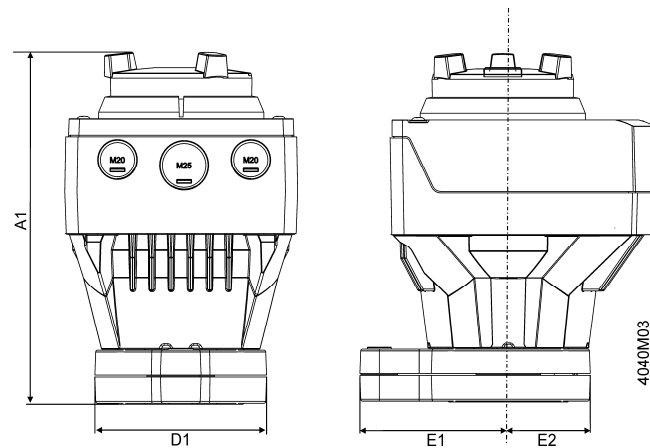

| Type | A1 | D1 | E1 | E2 |
|--------------------|-----|----|----|----|
| SAL.. with ASK3..N | 188 | 88 | 80 | 44 |
| With ASK39.1 | +25 | - | - | - |

Revision numbers

| Product no. | Valid from rev. no. |
|-------------|---------------------|
| SAL31.00T10 | ..E |
| SAL31.00T20 | ..D |
| SAL31.00T40 | ..B |
| SAL31.03T10 | ..E |
| SAL61.00T10 | ..E |
| SAL61.00T20 | ..D |
| SAL61.00T40 | ..B |
| SAL61.03T10 | ..E |
| SAL81.00T10 | ..E |
| SAL81.00T20 | ..D |
| SAL81.00T40 | ..B |
| SAL81.03T10 | ..E |

Issued by
Siemens Switzerland Ltd
Smart Infrastructure
Global Headquarters
Theilerstrasse 1a
6300 Zug
Switzerland
Tel. +41 58-724 24 24
www.siemens.com/buildingtechnologies

© Siemens Switzerland Ltd, 2011
Technical specifications and availability subject to change without notice.