

KESİT A-A
ÖLÇEK 1 : 1.5

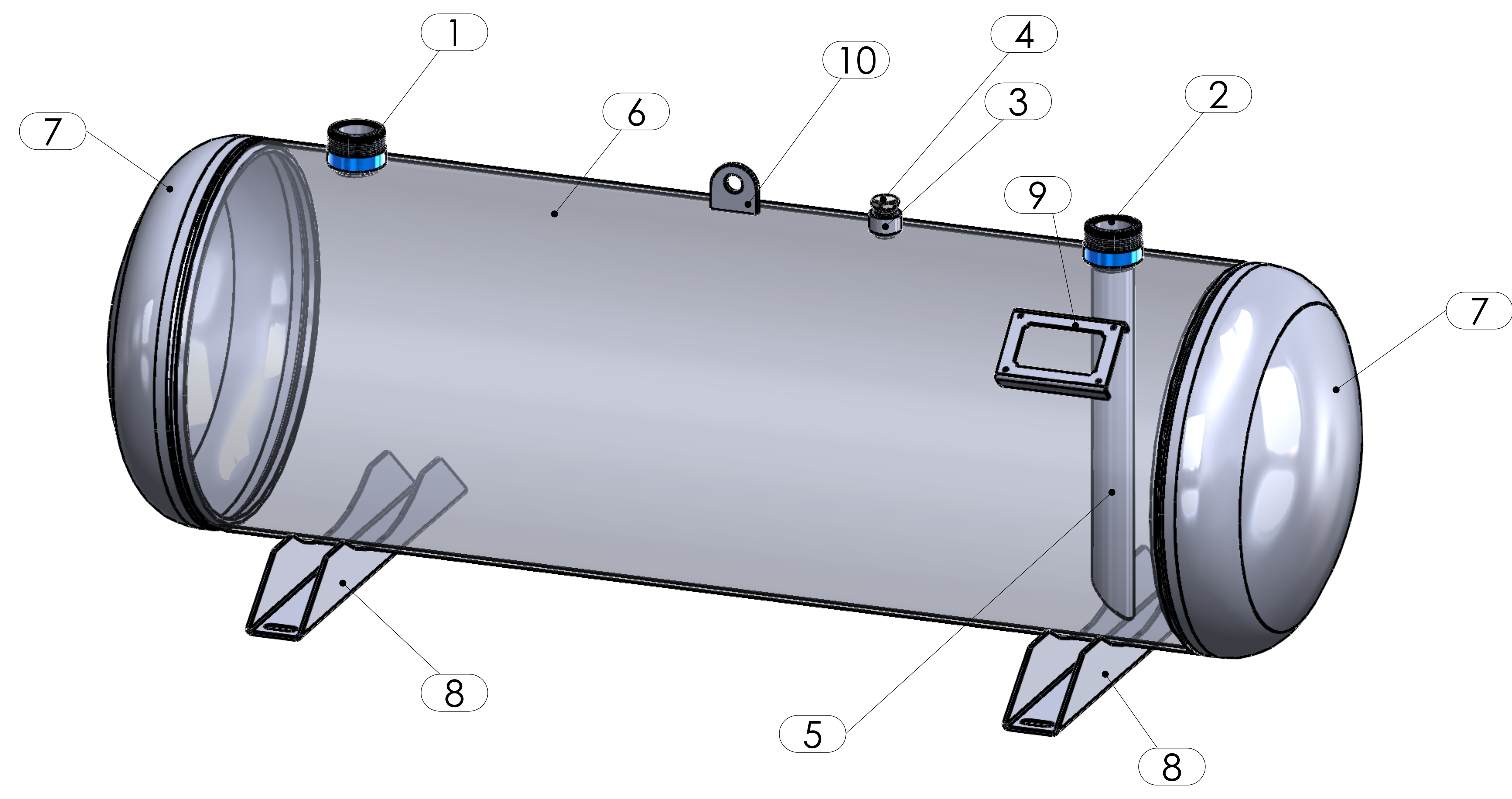

GVN STANDART PRODUCT	Customer
HORIZONTAL LIQUID RECEIVERS	Product
H10A.33b.150.A5.A5.F4	Code
	Customer Code

DESIGN DATA	
Capacity [Lt.]	150 Lt.
Design Pressure [PS]	33 Bar
Pneumatic Test Pressure [PT]	36 Bar
Hydraulic Test Pressure	48 Bar
Design Temperature [TS]	Min.-20C / Max.+130C
Cooler Fluid Type	HFC-CFC-HCFC
Fluid Group	2
Category	CAT IV / H1
Desing Calculation	EN 14276-1/EN 13445-3
Welded Joint Efficiency	0.85
Material Group (Shell / Head)	1.2
Testing Group	3b
Corrasion Allowance	0,5 mm
Ndt	10%
Packaging Size & Weight	00*00*00 & 00 Kg.
Drawed By	Ö.TÜRKER
Approved By	D.GÜL
Date	07.04.2022
Color	RAL 5009

MATERIAL DATA				
No	Connection	Model	Code	Qty
1	Inlet Connection	ROT 2 1/4" H:36	106.060.A05.001.001	1
2	Outlet Connection	ROT 2 1/4" H:36	106.060.A05.001.001	1
3	Safety Valve Conn.	NPT 1/2" H:18	106.060.F04.000.001	1
4	Blind Plug	NPT 1/2" Plug	106.130.F04.001.001	1
5	Pipe	Ø42x1,5 H:396	104.042.015.000.396	1
6	Shell	Ø406x5 H:1080	204.H10.33B.150.001	1
7	Head Torispheric	Ø406x5 H:125	101.033.406.001.000	2
8	Foot	480x60x65 t:3	105.002.406.001.001	2
9	Label Plate	120x80x2	105.006.002.120.080	1
10	Lifting	50x50x5	105.011.MP1.050.050	1

GENERAL NOTES

- Max. allowable operating pressure (PS) according to the temperature range;
- 1) Allowable operating temperature : min. -20C° / max. +130C° PS1 = 33 Bar
- 2) Allowable operating temperature : min. -20C° / max. -40C° PS2 = 24 Bar
- Unless otherwise specified dimensions in MM
- Unless otherwise specified do not scale
- Unless otherwise specified tube must be clean&free from burrs inside&outside& suitable for soldering
- Unless otherwise specified do not scale indicated thickness are min. after forming or machining
- Unless otherwise specified dimension tolerances according to EN 113445-4

REVISIONS			
No	Details Of Change	Date	By
01			
02			
03			

RELATED DRAWINGS		
No	Description	Drawing No
01		
02		



No	Assembly Codes	Qty
1	M002.000053	1