

GVN STANDART PRODUCT

Customer

HORIZONTAL LIQUID RECEIVERS

Product

H6A.33b.16.A2.A2.F4

Code

Customer Code

DESIGN DATA

Capacity [Lt.]	16 Lt.
Design Pressure [PS]	33 Bar
Pneumatic Test Pressure [PT]	36 Bar
Hydraulic Test Pressure	48 Bar
Design Temperature [TS]	Min.-20C / Max.+130C
Cooler Fluid Type	HFC-CFC-HCFC
Fluid Group	2
Category	CAT II / D1
Desing Calculation	EN 14276-1/EN 13445-3
Welded Joint Efficiency	0.85
Material Group (Shell / Head)	1.2
Testing Group	3b
Corrasion Allowance	0,5 mm
Ndt	10%
Packaging Size & Weight	00*00*00 & 00 Kg.
Drawed By	Ö.TÜRKER
Approved By	D.GÜL
Date	05.01.2023
Color	RAL 5009

MATERIAL DATA

No	Connection	Model	Code	Material	Qty
1	Inlet Connection	ROT. 1" H:25	106.060.A02.001.001	E275-ST44	1
2	Outlet Connection	ROT. 1" H:25	106.060.A02.001.001	E275-ST44	1
3	Safety Valve Conn.	NPT 1/2" H:18	106.060.F04.000.001	E275-ST44	1
4	Blind Plug	NPT 1/2" Plug	106.130.F04.001.001	E275	1
5	Pipe	Ø13x1 H:155	104.013.010.000.155	E235	1
6	Shell	168,3x3 H:760	204.H06.45B.016.001	EN10217-3 P355NH	1
7	Head - Torispheric	Ø168x3 H:50	101.045.168.001.000	EN10028-2 P355GH	2
8	Foot	195x40x27 t:3	105.002.168.001.001	DD13- EN10111	2

GENERAL NOTES

- Max. allowable operating pressure (PS) according to the temperature range;
- 1) Allowable operating temperature : min. -20C° / max. +130C° PS1 = 33 Bar
- 2) Allowable operating temperature : min. -20C° / max. -40C° PS2 = 24 Bar
- Unless otherwise specified dimensions in MM
- Unless otherwise specified do not scale
- Unless otherwise specified tube must be clean&free from burrs inside&outside&uitable for soldering
- Unless otherwise specified do not scale indicated thickness are min. after forming or machining
- Unless otherwise specified dimension tolerances according to EN 113445-4

REVISIONS

No	Details Of Change	Date	By
01			
02			
03			

RELATED DRAWINGS

No	Description	Drawing No
01		
02		

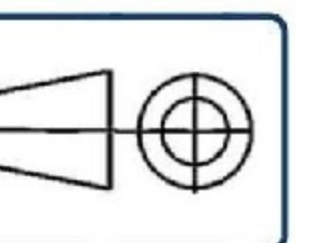

No	Assembly Codes	Qty
1	M002.000025	1

We reserve all rights in this document and in the information contained therein. Reproduction use or disclosure to third parties without express authority is strictly forbidden.

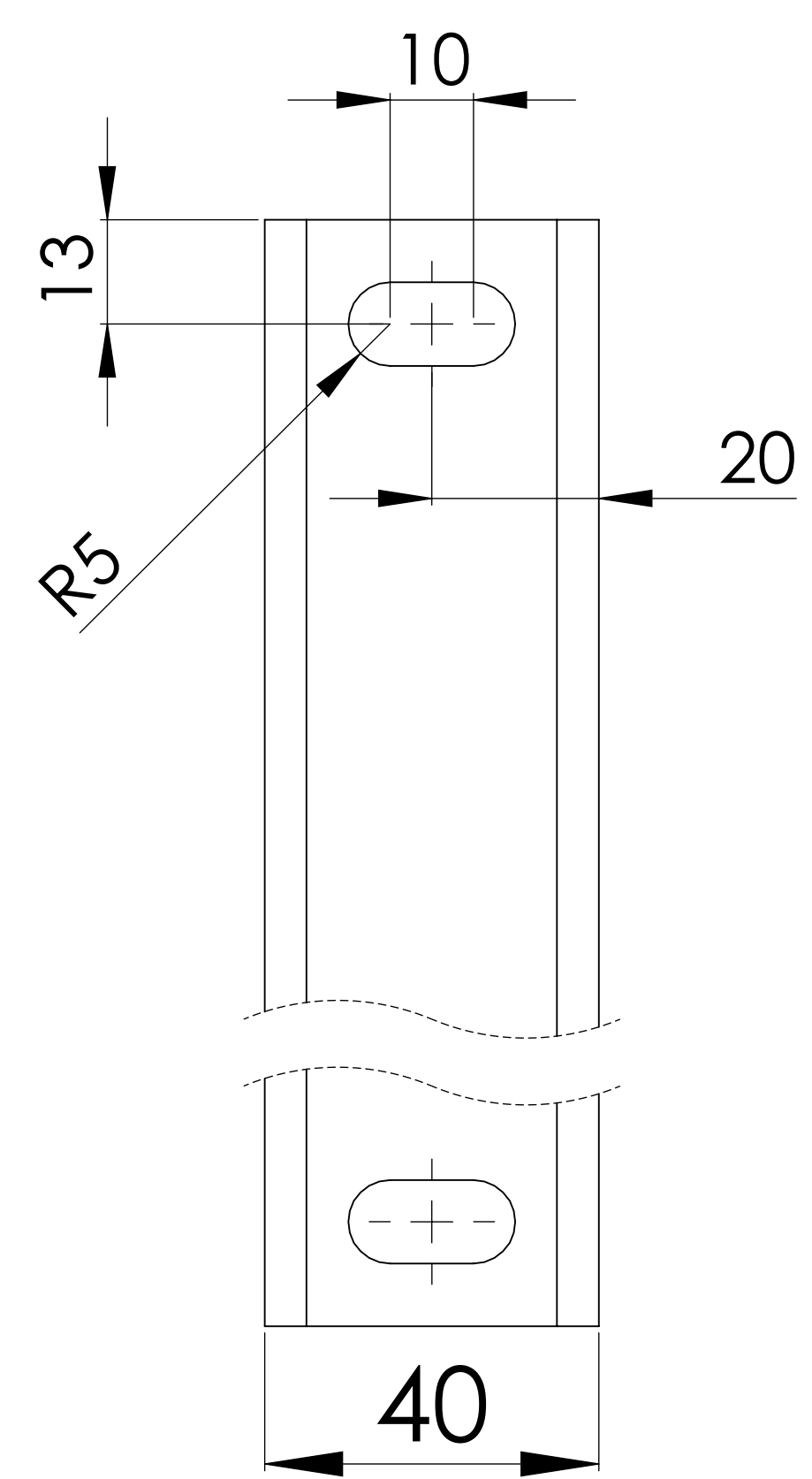
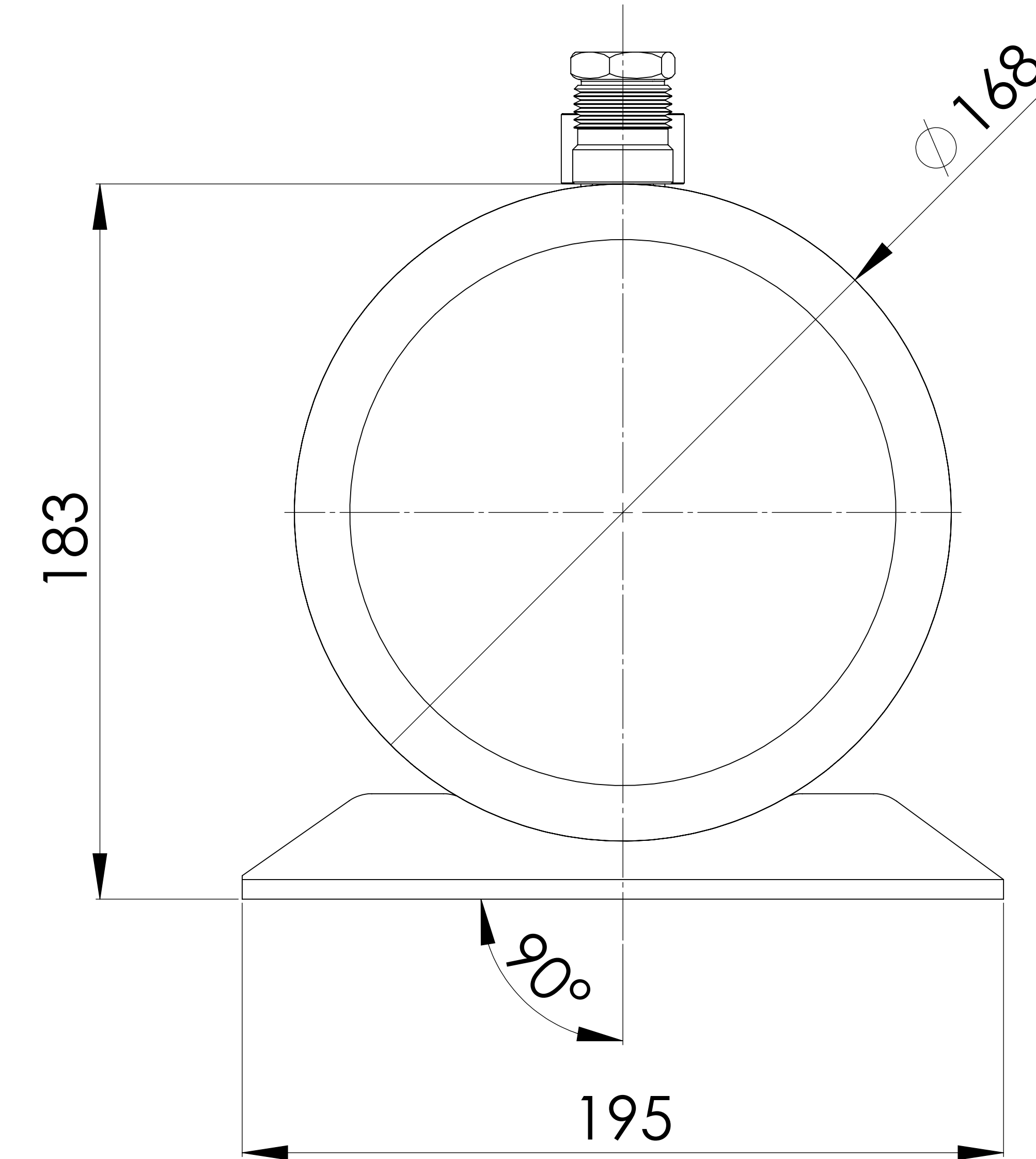
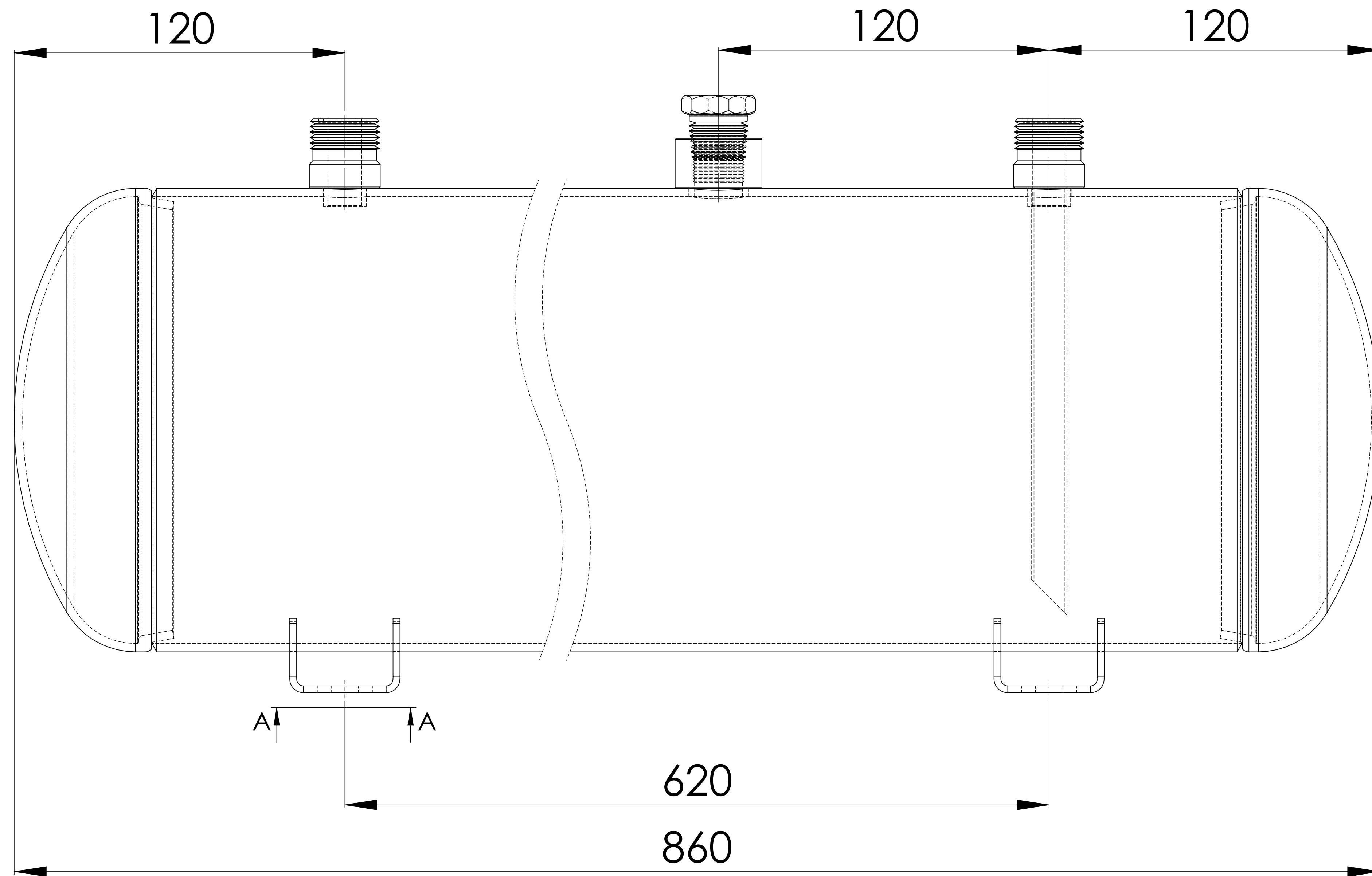

KESIT A-A
ÖLÇEK 1 : 0.8

