

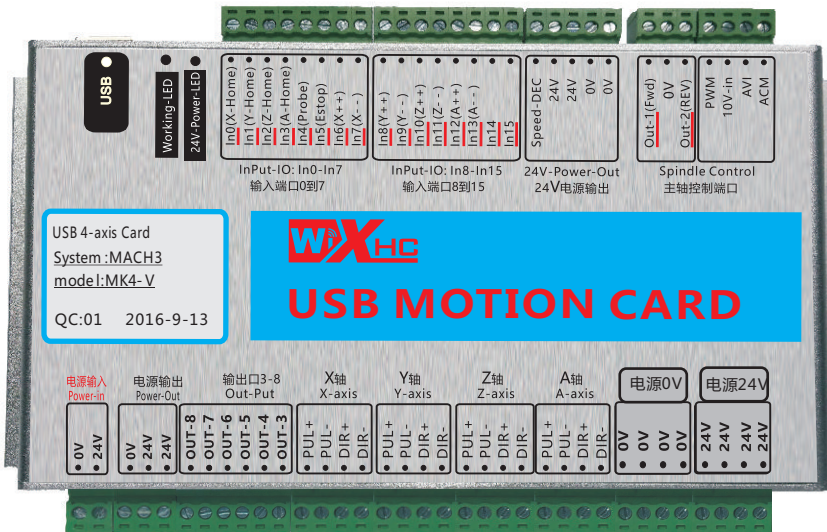

SUPPORT CNC SYSTEM:
MACH3 Only

MACH3 Breakout Board

MKX-V Specification



Size:184x127x30mm

MK3-V: USB Cable, 3 Axis Breakout Board

Model No.: MK4-V: USB Cable, 4 Axis Breakout Board

MK6-V: USB Cable, 6 Axis Breakout Board

Hardware Instruction

内部原理图

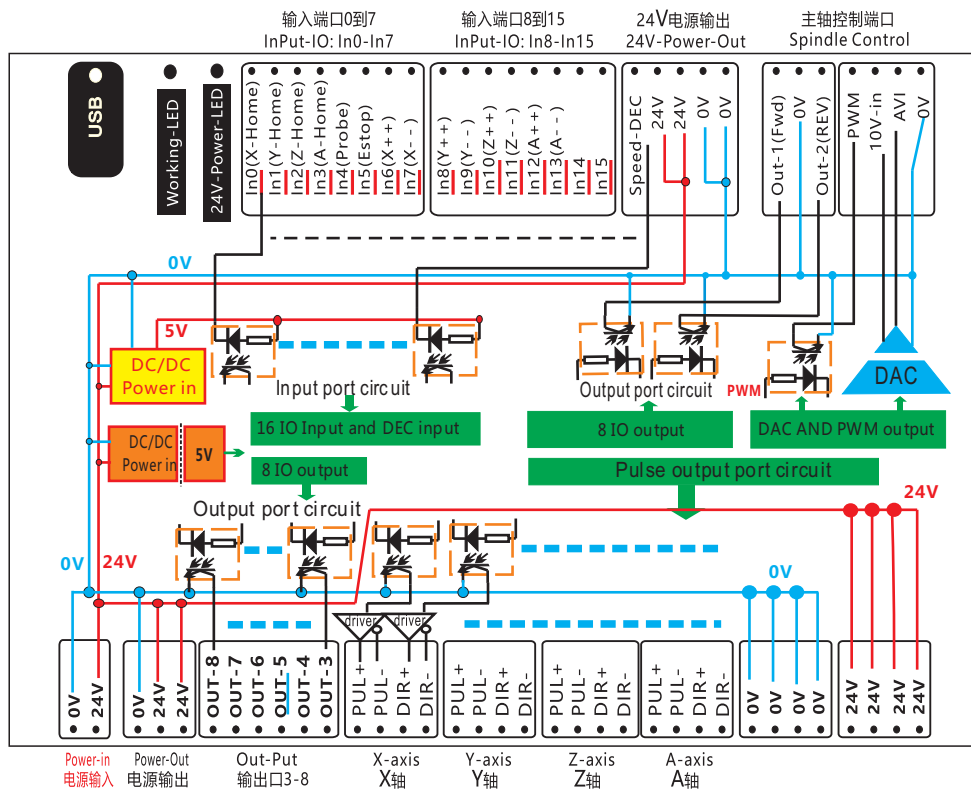

schematic diagram
控制卡内部原理图

Hardware Instruction

External Dimension

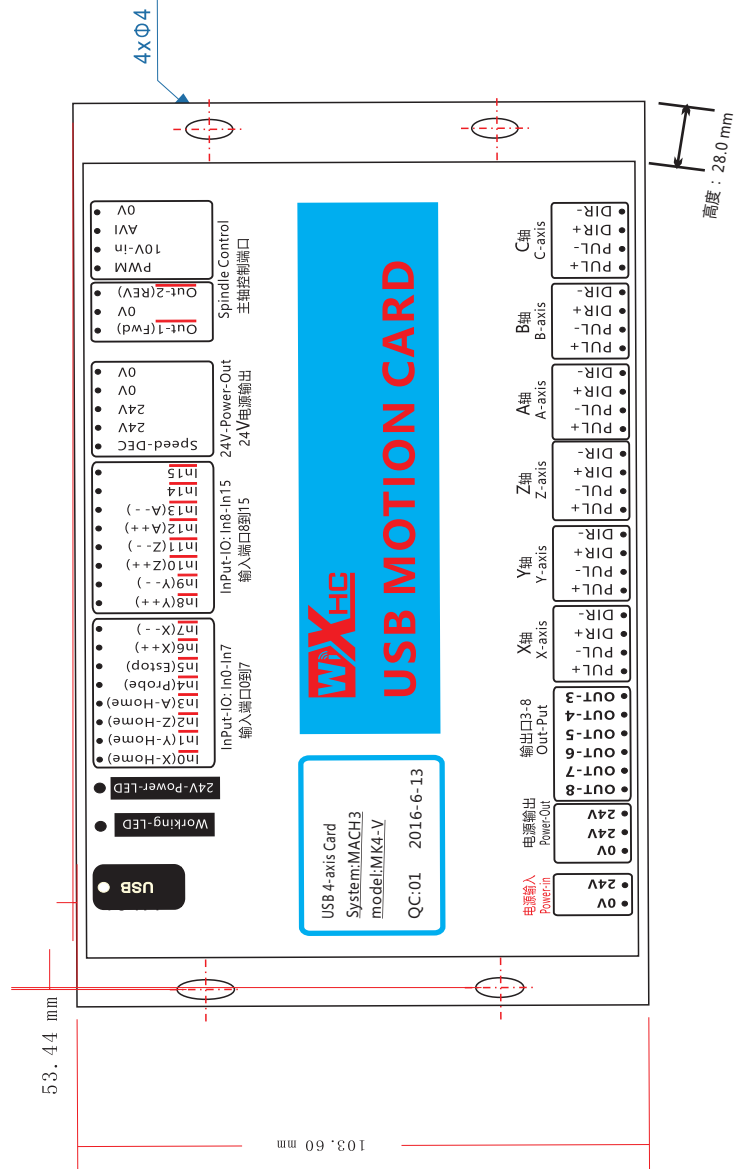

Hardware Instruction

Singal Instruction

Input signal

Offer 16pcs Input IO, All IO active low, input current 5mA, support 6-24V signal input.

Signal explanation as follow:

X-HOME: X Axis home signal input, corresponding MACH3 input IO is: P1. 0

Y-HOME: Y axis home signal input, corresponding MACH3 input IO is: P1. 1

Z-HOME: Z Axis home signal input, corresponding MACH3 input IO is: P1. 2

A-HOME: AAxis home signal input, corresponding MACH3 input IO is: P1. 3

PROBE: Tool setting signal input, corresponding MACH3 input IO is: P1. 4

IN5-IN15: Input IO, MACH3 Input IO are: P1. 5-P1.15

Inverter

MKX support spindle speed adjustment, support inverter port or PWM port.

MKX spindle port speed adjustment output, support 2 types: 0-10V analog voltage output or 0-5V analog voltage output or 5V PWM signal output

When you are using analog voltage output for speed adjustment, you need to offer DC voltage to our breakout board, DC voltage value related to max analog

voltage output value. For example, DC voltage output:10V, and analog voltage output will be between 0-10V.

Hardware Instruction

Specification

Power Supply

Before make it work, you need to offer DC24V power to our Breakout board.

Output

MKX-V offer 8pcs expandable Output IO, all IO active low;

Drive current 50mA,Support max 24V signal.

Spindle forward:OUT1: Corresponding MACH3output configuration is P1. 0

Spindle reverse: OUT2: Corresponding MACH3 Output configuration is P1. 1

Expandable Output IO 3-8: OUT3-8: Corresponding MACH3 Output configuration are: P1. 2-P1.7

Axis drive port

MKX offer max support 6 axis drive,MK3-V support 3 Axis, MK4-V support 4

Axis, MK6-V support 6 Axis.

MKX support Stepper/Servo drive, support pulse+Direction output and differential

Output, support max frequency of pulse output is 2000KHZ

Drive current is 20mA

Main function and advantages

📄 Features:

- ★ Fully supporting all Mach3 versions
- ★ Support save data when power off
- ★ Support spindle speed feedback
- ★ Support 3 meters USB cable
- ★ Supports Up 6-axis
- ★ Maximum step-pulse frequency is 2000KHz
- ★ Status indicator LED can be useful to show the USB connection, and working status by flashing.
- ★ 16 general-purpose input,8 output
- ★ has speed function, the spindle actual speed Mach3 interface in real-time display
- ★ all IO-port isolation, interference, stable performance
- ★ Full support for USB hot-swappable, the card is Monitoring USB connection status at any time.

Simple connection description

Application Connection Diagram

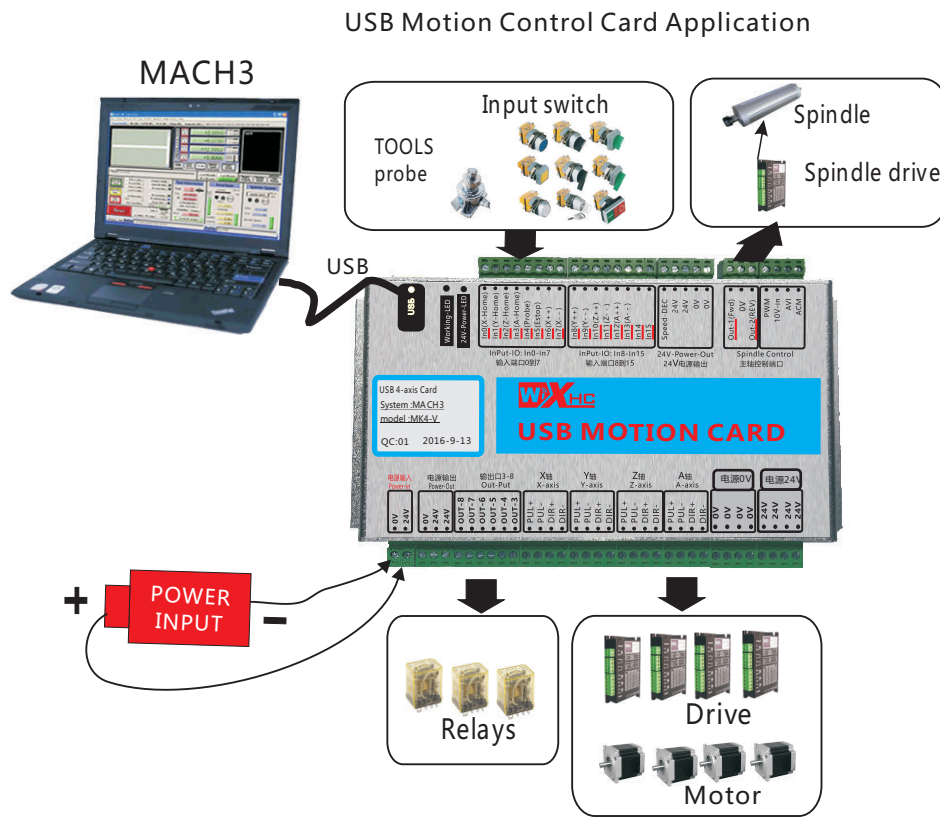

Support: 3-axis or 4-axis, or 6-axis

Mk3-V: 3-axis; Mk4-V: 4-axis; Mk6-V: 6-axis

Signal Description

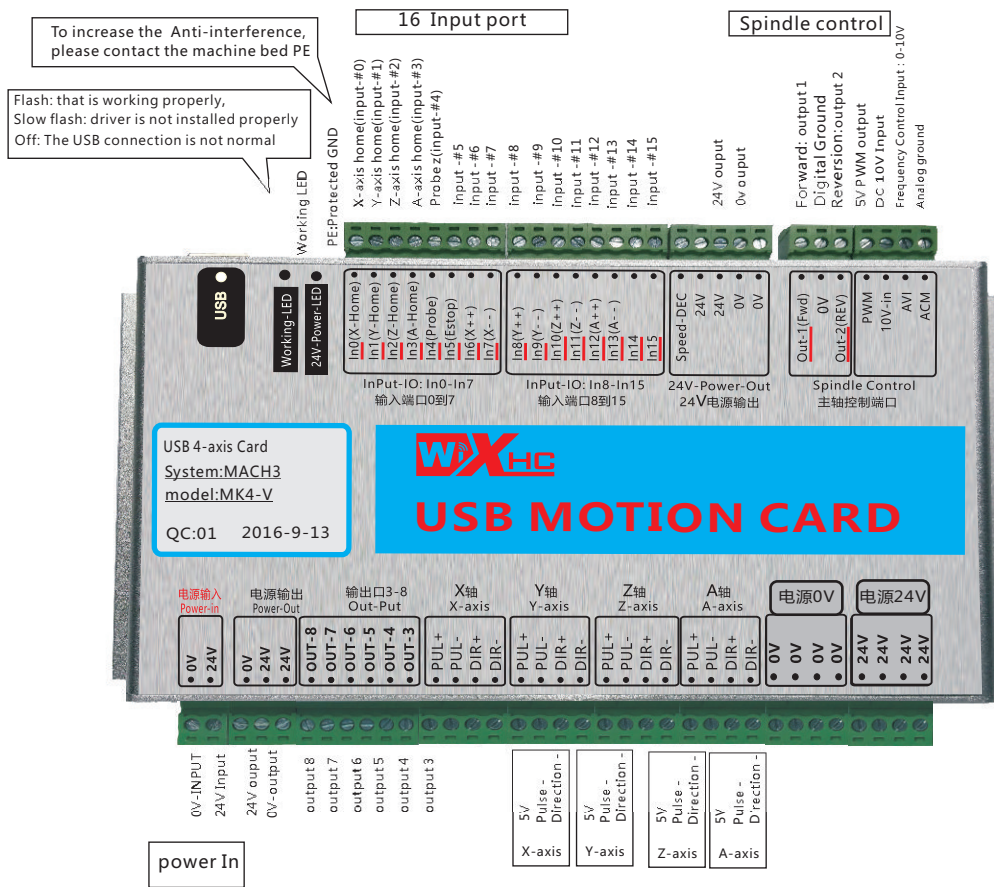

Wiring diagram shows

NOTE: If the inverter is turned on, the control card is not working properly because of interference caused by the inverter; Replace inverter.

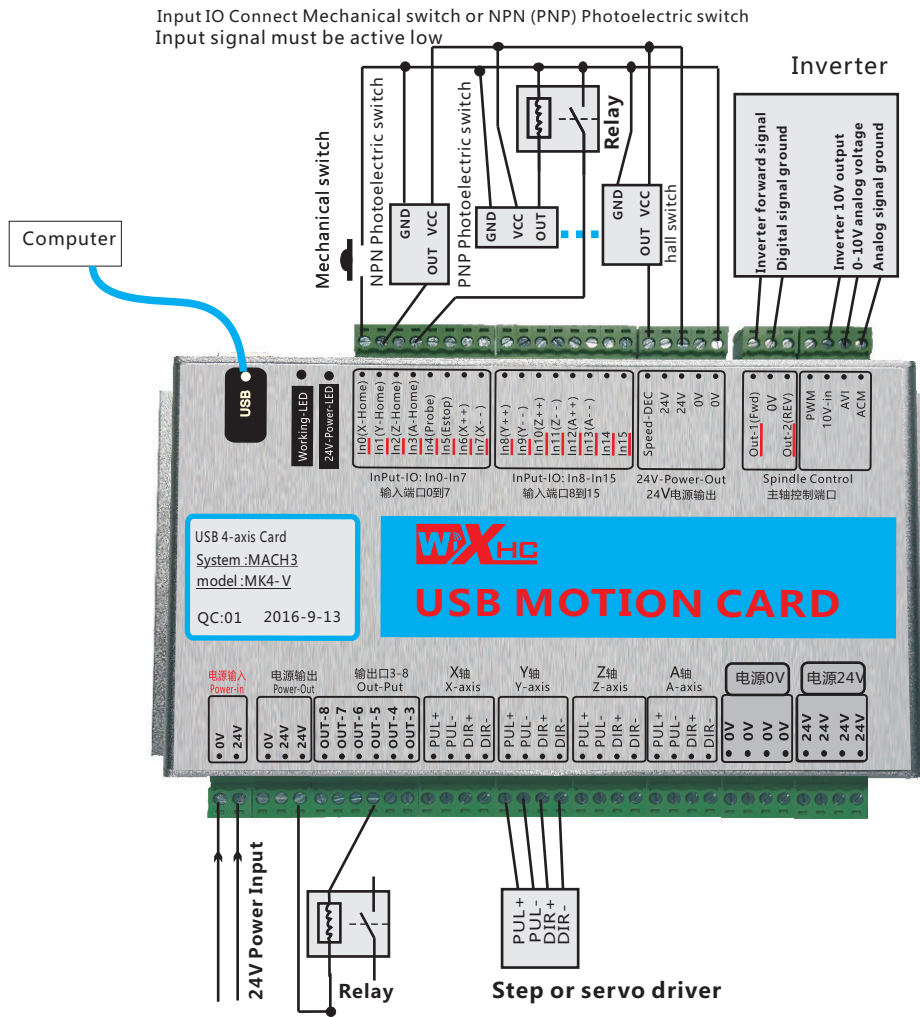

Electrical Characteristics

	Parameter Description	
axis output control:	Drive Current	Isolated open collector output; 5V, 20mA
	Drive	Pulse + direction output
	Output frequency	2000KHZ
	axes	MK3-V:3-axis;MK4-V:4-axis;MK6-V:6-axis
	Isolation Voltage	3.5KV
Spindle inverter output: 3 types of output modes	Analog voltage output	0—10V
	PWM output	5V, 1KHZ, Duty;0-100%
	Pulse+direction output	5V, 15HZ to 4KHZ
8 IO output	Drive Current	Isolation:50mA, 25V
	Isolation Voltage	3.5KV
16 IO input	Input Current	Isolated inputs, 5 mA, maximum voltage 25V
	Isolation Voltage	3.5KV
USB interface	Complies with USB2.0 standard	



- Install your mach3 software to PC which you control your CNC Machine.
- Connect our usb cable between our card and your PC, wait a few minutes Until usb driver finish installation automatically.
- Copy our configuration and driver files to mach3 folder we required.
- Check our wiring file on the manual or specification, connect our card to your stepper/ Servo motor driver correctly. If you have problem about wiring, please contact us for More details.
- ◆ Check our mach3 setting parameters and step per manual in the packing box and set your own parameters in right way.

Power supply wiring

Wiring

NO.1 : Offer Power supply to card

DC24V,0.5A

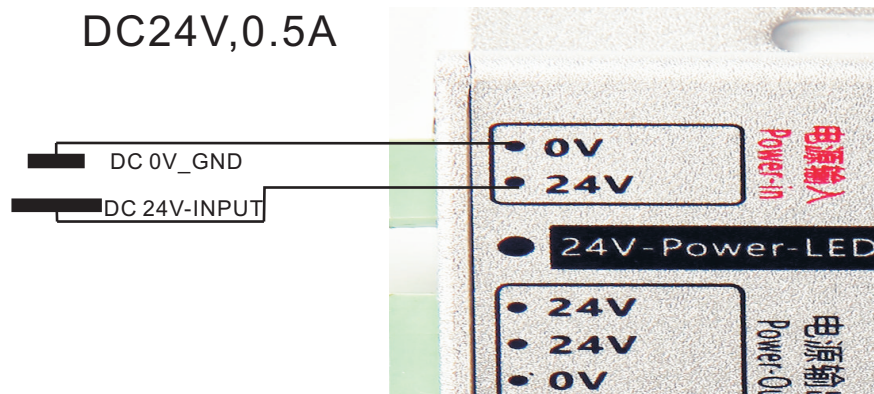

Before using our breakout board, please offer
DC24V power supply to make it works,
Current 0.5A

NO.2 : Drive wiring: Support Stepper/Servo drive,Differential output signal

NO.3 : Spindle control-Inverter connection

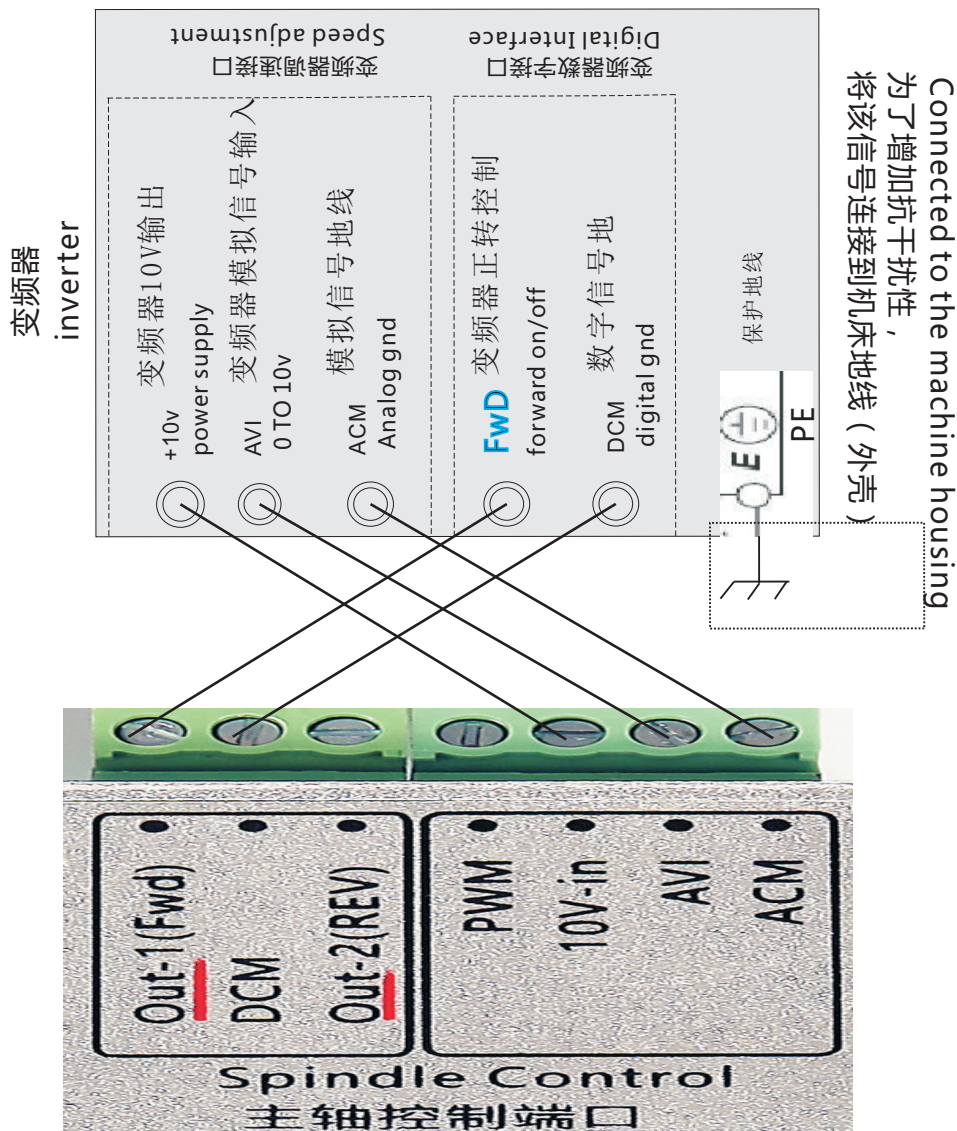

Wiring

Spindle Control : Stepper/ Servo Drive

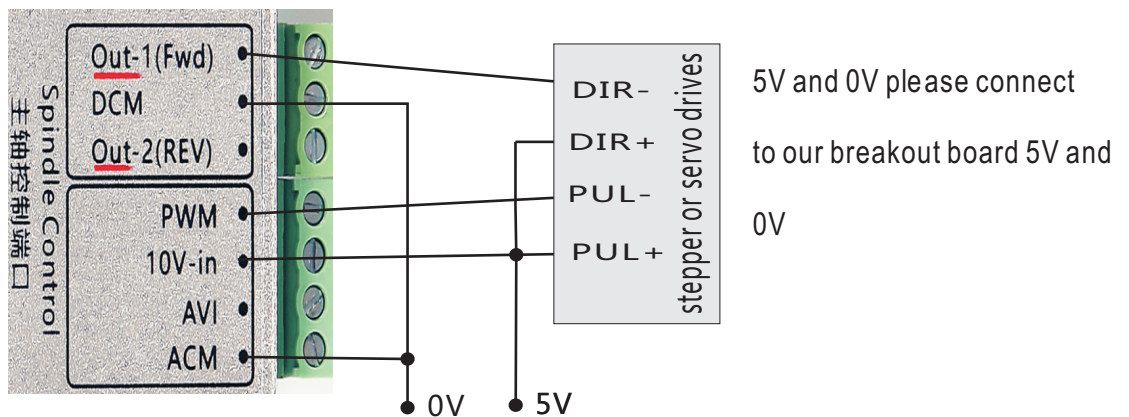

NO.4 : Output Relay Interface : OUT3 to OUT8 Relay Interface

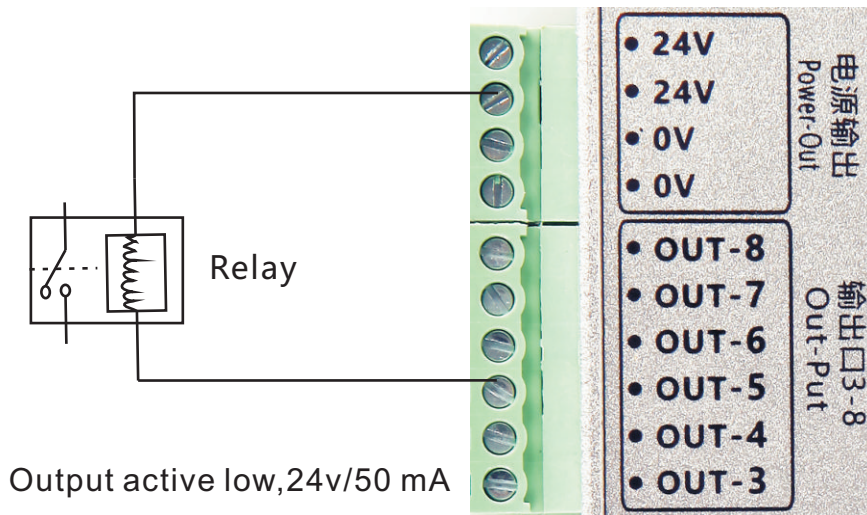

Wiring

NO.5 : input Interface : 16 input port;In0 to In15,limit switch.Active Low

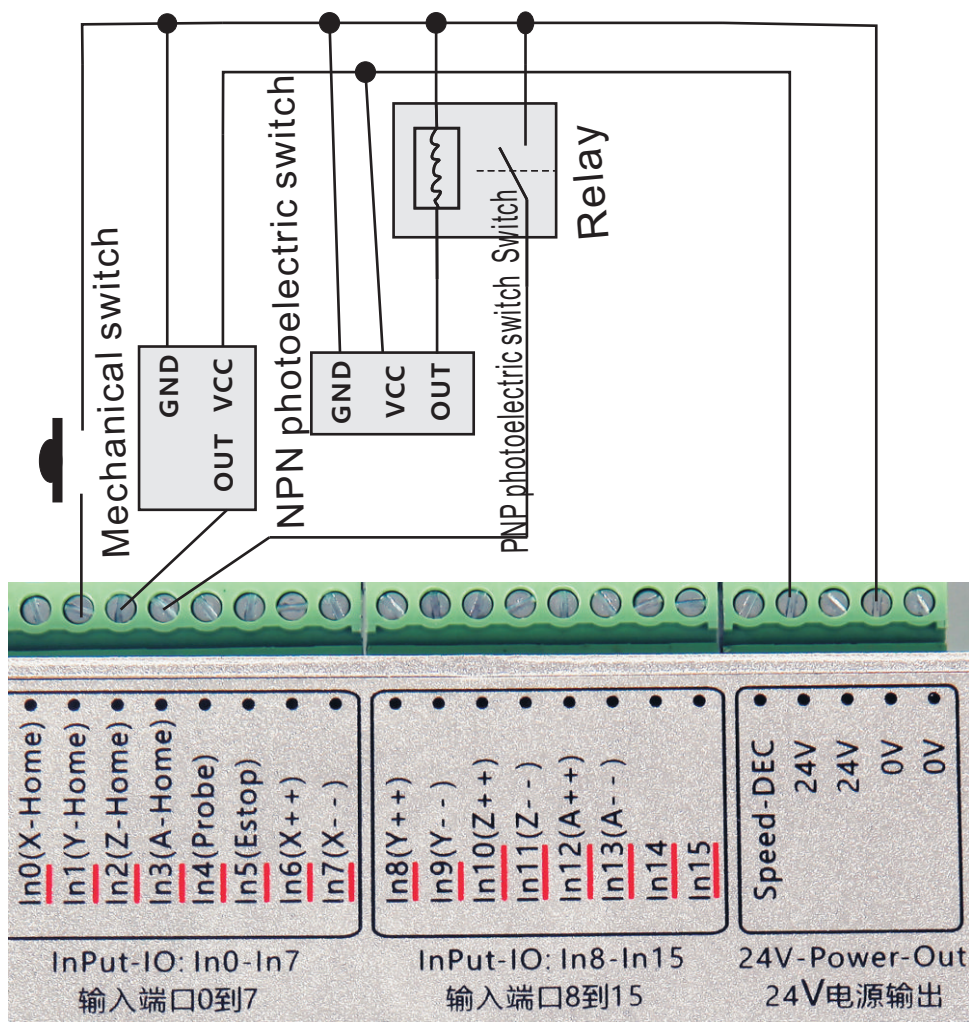

New Function

Break continue: when the control card suddenly power off, the control card chip automatically save the current G code line number. Control card plug-in will display saved the number of lines.

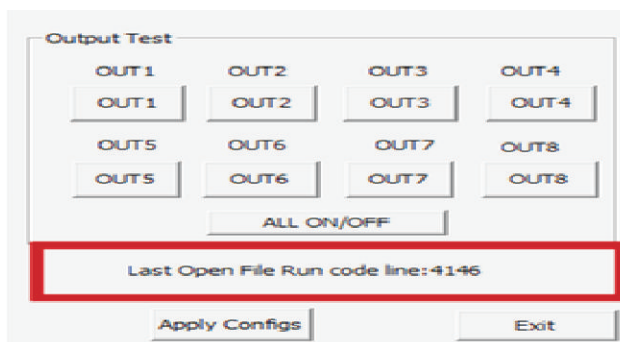

◦ Waiting until the control card is connected to the power supply next, load the G code program, click the power to continue to the break continue button, Mach3 software automatically from the last save the number of lines to start running.

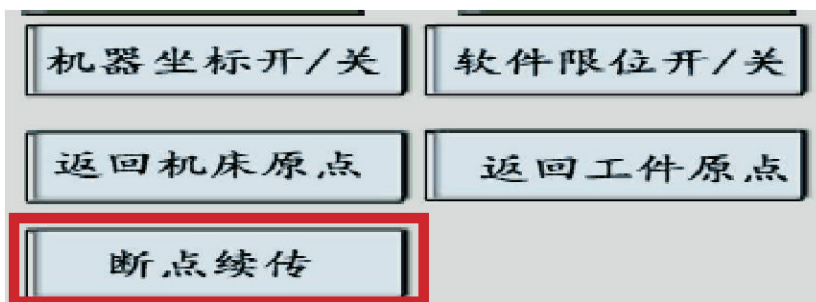

=====New Function=====

Spindle speed feedback

spindle speed feedback through the sens or feedback to Input port "Speed-DEC", and then display the RPM speed on the Mach3 software. Maximum support feedback input Pulse frequency 20KHZ.

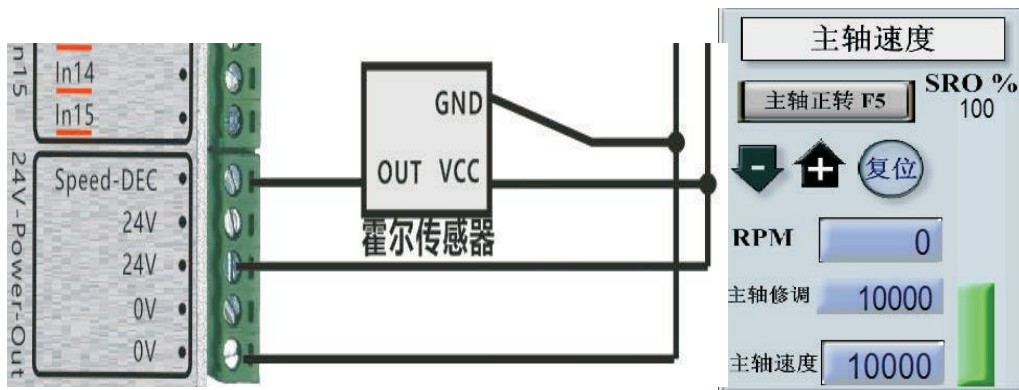

USB anti-interference ability: full new designed independent USB data processor, to prevent the interference to USB communication, more stable and reliable. Suitable for plasma cutting and automatic welding and so on.

