

N105G2/G3 CNC System

Manufacturers' Manual

4th Edition

Weihong Electronic Technology Co., Ltd.

The copyright of this manual belongs to Weihong Electronic Technology Co., Ltd. (hereinafter referred to as Weihong Company). This manual and any image, table, data or other information contained in this manual may not be reproduced, transferred, or translated without any prior written permission of Weihong Company.

The information contained in this manual is constantly being updated. You can login to the official website of Weihong Company www.weihong.com.cn to download the latest PDF edition for free.

4th Edition, July, 2015

Third Printing, July, 2015

112 pages

Preface

About This Manual

This manual is intended for machine tool builders and users. If you use the CNC system for the first time, you need to read through the manual. If you are experienced with the system, you can search for the desired information via the contents.

With 11 chapters, this manual can be divided into 5 parts, as follows:

- 1) Part 1: preface, introducing the precautions about transportation and storage, installation, wiring, debugging, usage, and so on. You need to read them carefully beforehand to ensure safe operations.
- 2) Part 2: introduction to hardware used together with the system, including Chapter 1&2&4. Chapter 1 introduces basic configuration or the components of the system and the mechanical dimension. Chapter 2 introduces terminal pin signals and wiring of NK105 three axes control box. Chapter 4 lists all keys on NK105G2 and NK105G3 operation panels, introducing functions of single key and key combinations.
- 3) Part 3: software operation, including Chapter 5&6&9. It focuses on how to use the system in real machining, taking NK105G2 as an example. Specifically, Chapter 5 comprehensively introduces machining steps from the perspective of machine debugging; Chapter 6 introduces menu pages and menu items of the system; Chapter 9 introduces update operations of the system.
- 4) Part 4: Chapter 7~8, specially introduces operations of NK105G3 and separate software with cylinder ATC function and linear ATC function.
- 5) Part 5: Chapter 10~11. Chapter 10 gives the parameter settings of drivers of varied brands as well as their wiring diagram with the NK105 system. Chapter 11 is software license agreement.

Applicable Product Models

This manual is applicable to NK105 G2/G3 CNC system. Refer to the table below for details:

Product Model	Remarks
NK105 G2/G3 CNC System	Herein referred to NK105G2/G3 as abbreviation.

Contact Us

You can contact us by the following info for technical support and pre-sales/after-sales service:

Company Name: Weihong Electronic Technology Co., Ltd.
Headquarters Address: No. 29, 2338 Duhui Rd., Minhang, Shanghai 201108
Tel: +86-21-33587550
Fax: +86-21-33587519
Website: <http://en.weihong.com.cn>
E-mail: sales@weihong.com.cn

Revision History

You can refer to the following table for the revision records of each edition.

Date	Edition	Revision Contents
2015.07	R4	1) Add contents related to screw error compensation and compensation file import in Chapter 6.6.6. 2) Update tool length measurement in Chapter 8.1.5. Add three types of measurement methods, namely, manual setting, single measurement and all measurement. 3) Add parameters related to change tool stroke. 4) Update parameter information and some menu interfaces. 5) Update system update in Chapter 9. 6) Other revisions.

Precautions

Precautions can be divided into caution and warning according to the degree of possible loss or injury in case of negligence or omission of precautions stipulated in this manual.



: General info, mainly for informing, such as supplementary instructions and conditions to enable a function. In case of negligence or omission of this kind of precautions, you may not activate a function. Note that in some circumstances, negligence or omission of even this kind of precautions could cause physical injury or machine damage.



: Warning info requiring special attention. In case of negligence or omission of this kind of precautions, you may suffer physical injury, or even death, machine damage or other losses.



1) Precautions Related to Storage and Transportation

- The products should be transported properly in terms of the weight;
- An excess of specified quantity of stacking products is prohibited;
- Climbing, standing or placing heavy loads on the products is prohibited;
- Dragging or carrying the products via cables or devices connected to them is prohibited;

2) Precautions Related to Installation

- Only when this equipment installed in the qualified electricity cabinet can it be used. The



construction of the cabinet must reach IP54 grade of protection;

- Paste sealing strips on the joint of the cabinet to seal all the cracks;
- Cable entry should be sealed while easy-to-open on the spot;
- A fan or heat exchanger should be adopted for the heat dissipation and air convection of the cabinet;
- If a fan is adopted, air strainer is a must in air inlet or air outlet;
- Dust or cutting fluids may have access to the CNC device via the tiny cracks and tuyere. Therefore it is necessary to pay attention to the surroundings and air flow direction of the air vent to make sure that the outflow gas is towards pollution source;
- 100 mm space should be preserved between the back of the CNC device and the cabinet wall for plugging cable connected with the device and the ventilation & heat dissipation in the cabinet;
- Space between this device and other equipments should also be preserved according to the requirements;
- The product should be installed firmly and without vibration. During installing, casting, knocking, striking, or loading on the product is forbidden;
- To reduce electromagnetic interference, power-supply components used should be above AC or DC 50V and the space between cable and CNC device should be preserved above 100mm;
- It will be better if CNC device is installed at a position facilitating debugging and maintenance.

3) Precautions Related to Wiring

- Only qualified people are allowed to participate in the wiring and checking;
- The CNC device should be grounded reliably and grounding resistance should be less than 4 ohm. Neutral line is absolutely not allowed to replace earth wire. Otherwise, it may result in malfunction of the device due to the interference;
- Wiring should be firm and steady, or misoperation may occur;
- Voltage values and positive & negative polarity of any connection plug should be in accordance with specifications set forth in the manual, or it may result in breakdowns such as short circuit and permanent damage to the device;
- To guard against electric shock or CNC device damage, fingers should keep dry before plugging or touching switch; The connecting wire should not be damaged and squeezed,



or the leakage or short circuit may occur;

- It is prohibited to plug or open the chassis of CNC device when power on.

4) Precautions Related to Running & Debugging

- Parameters setting should be checked before running, since wrong setting may lead to accidental movements;
- Modification to parameters should be within the allowable range, or such breakdowns as unsteady running and machine damage will occur.

5) Precautions in Use

- Before power-on, please make sure that the switch is on blackout to avoid occasional start-up;
- Please check the electromagnetic compatibility during electrical design in order to avoid or reduce electromagnetic interference to the CNC device. A low pass filter should be employed to reduce electromagnetic interference if there are other electrical devices nearby;
- It is not allowed to frequently power on and power off. It is recommended to power up the machine again at least one (1) minute later after power failure or blackout.



1) Precautions Related to Product and Manual

- Matters related to restrictions and functions available stipulated in the manuals issued by the machine manufacturer are prior to those in this manual;
- This manual assumes all the optional functions are available, which you must confirm through manuals issued by the machine manufacturer;
Please refer to manuals issued by the machine manufacturer for the instructions of machine tools;
- Functions, and software interfaces vary with the system and the version of software.
Before using the system, you must confirm the specifications.



2) Precautions When Opening the Package

- Please make sure that the products are what you have ordered;
- Check if the products are damaged in transit;
- Check if the components and accessories are damaged or missing in terms of the detailed list;
- Please contact us promptly if product discrepancy, accessory missing or transit damage occurs.

Contents

1.	SUMMARIZATION.....	1
1.1.	System Introduction.....	1
1.2.	Basic Configuration.....	1
1.3.	Mechanical Dimension	1
2.	WIRING.....	3
2.1.	Terminal Specification.....	3
2.1.1.	Terminal Wiring When General Software Installed.....	3
2.2.	Input Interface of +24V Power.....	5
2.3.	USB Interface	5
3.	BASIC CONCEPTS	6
3.1.	Operation Mode and State.....	6
3.1.1.	Operation Mode	6
3.1.2.	Operation State	6
3.2.	Coordinate System.....	7
3.2.1.	Machine Coordinate System.....	8
3.2.2.	Workpiece Coordinate System.....	8
4.	FUNCTIONS & OPERATION METHODS OF PANEL KEYS.....	10
4.1.	NK105G2 Panel Keys.....	10
4.1.1.	Function Information of Each Single-key.....	10
4.1.2.	Function Information of Combination Key	12
4.2.	NK105G3 Panel Keys.....	14
4.2.1.	Function Information of Each Single-key.....	14
4.2.2.	Function Information of Combination Key	16
4.3.	Modification Method of System Parameters	17
4.4.	System Start-up	18

5.	MACHINE TOOL DEBUGGING	20
5.1.	Adjustment of Axis Direction and Pulse Equivalent	20
5.1.1.	Adjustment of Axis Direction	20
5.1.2.	Adjustment of Pulse Equivalent	20
5.2.	Setup of Machine Stroke	22
5.3.	Port Polarity	23
5.4.	Back to Machine Origin	24
5.4.1.	Parameter Setup of Backing to Machine Origin	24
5.4.2.	Operation Mode of Backing to Machine origin	25
5.5.	Spindle Debugging	26
5.5.1.	Spindle Setup	26
5.5.2.	Park MCS Site	26
5.5.3.	Spindle Stop	27
5.6.	Manual Machining	27
5.6.1.	Mode Selection of Manual Machining	28
5.6.2.	Parameter Setting of Manual Machining	29
5.7.	Automatic Machining	30
5.7.1.	Load File	30
5.7.2.	WCS Selection	31
5.7.3.	Set Workpiece Origin	31
5.7.4.	Start Machining	32
5.8.	Adjustment during Automatic Machining	32
5.8.1.	Feedrate Override Adjustment	32
5.8.2.	Spindle Speed Adjustment	32
5.8.3.	Machining Pause and Jiggle	33
5.8.4.	Continuing Machining after Pause	33
5.8.5.	Soft Limit Handling	33
5.8.6.	Hard Limit Handling	34
6.	MENU PAGE	35
6.1.	Summarization	35
6.2.	Local Files/ USB Files	37

6.3. Operations	38
6.3.1. Back REF Point	38
6.3.2. Rect Machining.....	38
6.3.3. Select Line No	39
6.3.4. Machining Info	39
6.3.5. Park MCS Site	40
6.3.6. Select WCS.....	40
6.3.7. Array Process.....	40
6.3.8. Origin List.....	41
6.3.9. Nearby Process	41
6.4. Oper Param (Operator Parameters)	41
6.5. Mfr Param (Manufacturer Parameters).....	45
6.6. Param Upkeep (Parameter Maintenance)	49
6.6.1. Backup Params	49
6.6.2. Restore Backup.....	49
6.6.3. Factory Params	50
6.6.4. Export Parameters.....	50
6.6.5. Import Parameters.....	50
6.6.6. Import Error Data	51
6.7. System Upkeep.....	54
6.7.1. Language.....	54
6.7.2. Export Log	55
6.7.3. System Update.....	55
6.7.4. Register	56
6.7.5. Help	56
6.7.6. Reboot.....	56
6.7.7. Exit.....	57
6.7.8. Delete Log	57
6.7.9. Disk Space	57
6.7.10. Delete Info	57
6.7.11. Modify Code.....	57
6.8. Diagnosis.....	57
6.8.1. System Info.....	58
6.8.2. Ports List.....	58

6.8.3.	Keypress Diag.....	58
6.8.4.	Inport Diag.....	58
6.8.5.	Outport Diag.....	58
6.8.6.	LED Diag.....	58
7.	MACHINING OPERATIONS OF NK105G3	59
7.1.	Manual Machining.....	59
7.1.1.	Mode Selection of Manual Machining	59
7.1.2.	Parameter Setting of Manual Machining	60
7.2.	Automatic Machining	61
7.2.1.	Load File.....	61
7.2.2.	WCS Selection.....	61
7.2.3.	Set Workpiece Origin.....	62
7.2.4.	Start Machining.....	63
7.3.	Adjustment during Automatic Machining	63
7.3.1.	Feedrate Override Adjustment	63
7.3.2.	Spindle Speed Adjustment	63
7.3.3.	Machining Pause and Jiggle	63
7.3.4.	Soft Limit Handling.....	64
7.3.5.	Hard Limit Handling.....	64
7.3.6.	E-stop Handling	65
8.	CYLINDER ATC AND LINEAR ATC FUNCTION	66
8.1.	Cylinder ATC	66
8.1.1.	Function Information of Combination Keys.....	66
8.1.2.	Tool Change Parameters	69
8.1.3.	Cylinder Operation Method	69
8.1.4.	Process of Tool Change	70
8.1.5.	Tool Measurement Page.....	70
8.1.6.	Breakpoint Resume.....	71
8.1.7.	Simulation.....	72
8.2.	Linear ATC	72
8.2.1.	Function Information of Combination Keys.....	72
8.2.2.	Tool Change Parameters	75

8.2.3.	Clamp/Unclamp Tool Manually.....	75
8.2.4.	Process of Linear Tool Change	76
8.2.5.	Auto Measure of Tool Length.....	77
8.2.6.	Process of Tool Measurement	77
9.	SYSTEM UPDATE	78
9.1.	Software Update	78
9.2.	System Mirror Update	78
10.	DRIVER.....	80
10.1.	Driver Parameters	80
10.1.1.	Parameter Setting of WISE Servo Driver	81
10.1.2.	Parameter Setting of YASKAWA Σ -II Servo Driver.....	83
10.1.3.	Parameter Setting of DELTA ASDA-A Servo Driver	85
10.1.4.	Parameter Setting of DELTA ASDA-A2 Servo Driver	87
10.1.5.	Parameter Setting of PANASONIC MINAS_A4 Servo Driver	89
10.1.6.	Parameter Setting of FUJI FALDIC- β Servo Driver	90
10.1.7.	Parameter Setting of STONE GS Servo Driver	91
10.1.8.	Parameter Setting of MITSUBISHI MR-E Servo Driver	92
10.2.	Wiring Diagram of NK105 and Driver	94
10.2.1.	Wiring Diagram of NK105 and Differential Input Stepping Driver	94
10.2.2.	Wiring Diagram of WISE Servo Driver.....	94
10.2.3.	Wiring Diagram of YASKAWA Σ -II Servo Driver	95
10.2.4.	Wiring Diagram of DELTA ASDA Servo Driver.....	95
10.2.5.	Wiring Diagram of PANASONIC MINAS_A4 Servo Driver	96
10.2.6.	Wiring Diagram of MITSUBISHI MR-E Servo Driver.....	97
10.2.7.	Wiring Diagram of FUJI FALDIC- β Servo Driver	97
10.2.8.	Wiring Diagram of STONE GS Servo Driver	98
11.	SOFTWARE LICENSE AGREEMENT	99

1. Summarization

1.1. System Introduction

Independently-developed NK105G2/G3 provides a whole set of solutions to engraving machines based on embedded industrial control platform.

NK105G2/G3 integrated CNC system is composed of a host system and an operation panel. Also called control box, the host system integrates system control card, terminal board and other parts, and makes connection with the operation panel via a 15-pin extension cable.

The up and down ends at the back of the control box are used to inlay terminals while the left side includes an USB interface and a DB15 interface. The DB15 interface is for connection with the operation panel, while the USB interface for external connection with USB equipment (e.g. USB flash drive).

Also called handheld box, the operation panel is concise and portable, connected with the host system via a 15-pin extension cable, so it can break away from the distribution box and facilitate machine tool control. And its moving distance is only restricted by the length of extension cable.

1.2. Basic Configuration

Basic configuration of NK105G2 system:

NK105G2 handheld box
NK105 three axes control box

Basic configuration of NK105G3 system:

NK105G3 handheld box
NK105 three axes control box

1.3. Mechanical Dimension

The integral thickness of NK105 host system is 218.3mm, with terminals embedded at its up and down ends. Fig. 1-1 is the dimensional drawing and cut-out drawing of NK105G2/G3 control box (unit: mm).

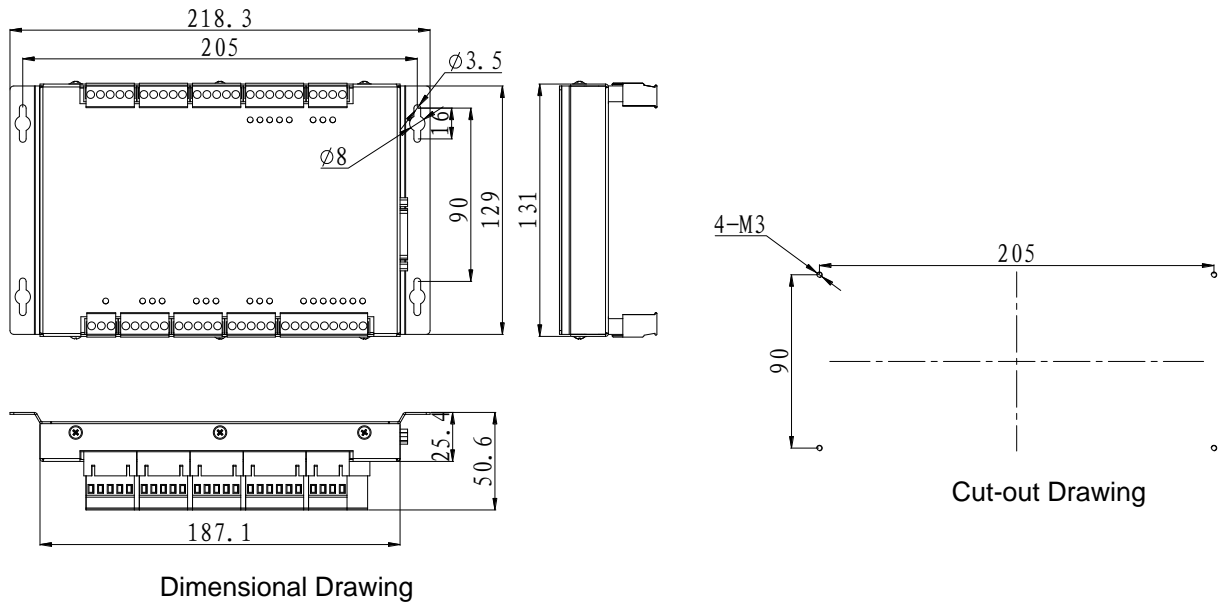

Fig. 1-1 Dimensional drawing and cut-out drawing of NK105G2/G3 control box

2. Wiring

2.1. Terminal Specification

2.1.1. Terminal Wiring When General Software Installed

NK105 terminals are inlaid at the up and down ends of the control box. The detailed wiring diagram is as shown in Fig. 2-1, when general software is installed.

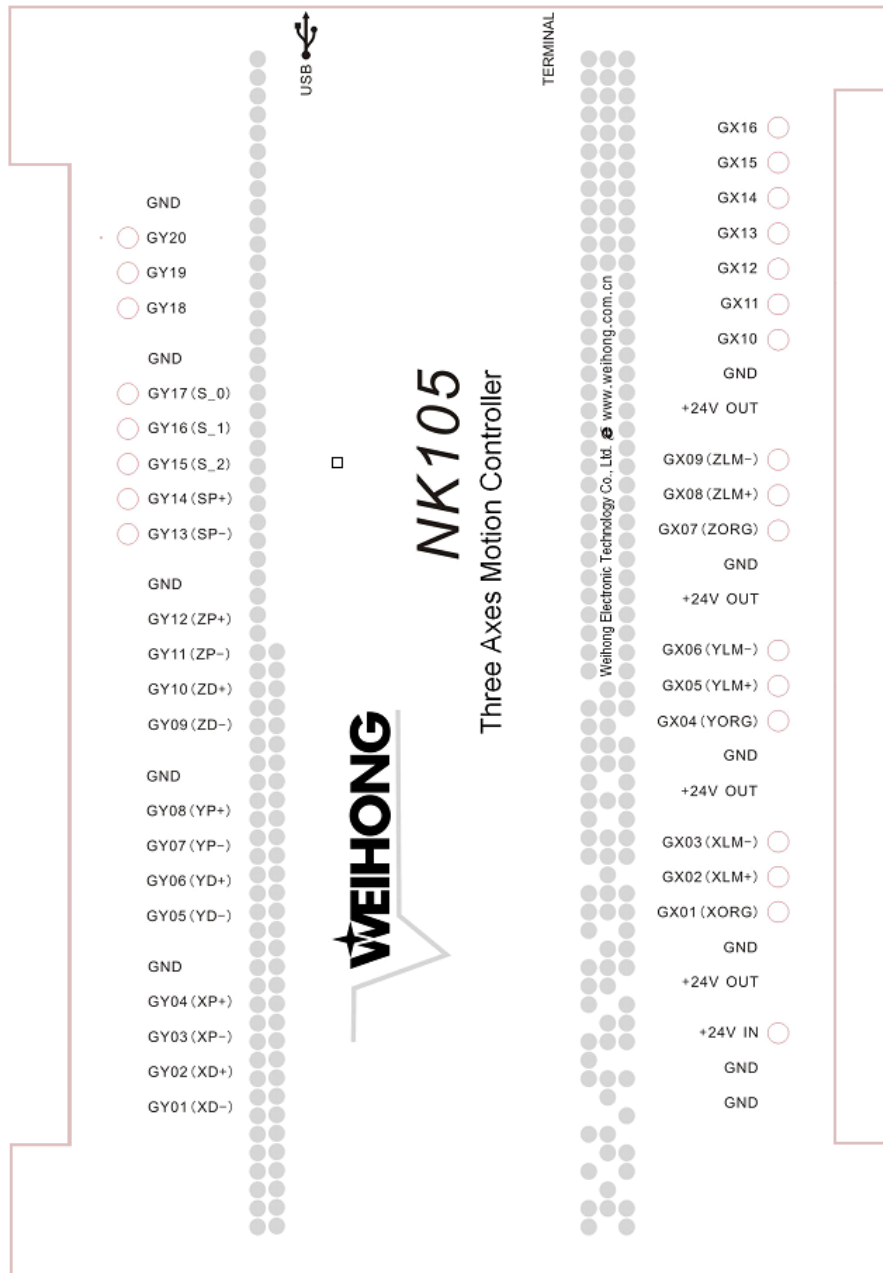

Fig. 2-1 Terminals on NK105 control box

The detailed explanation of terminal pin signals is as shown in Table 1 and Table 2.

Table 1 Output signals

Silk-printed name	Corresponding signal	Remark
GY01(XD-)	Negative differential signal of X-axis direction	XD+ and XD- are differential pair signals of X-axis direction.
GY02(XD+)	Positive differential signal of X-axis direction	
GY03(XP-)	Negative differential signal of X-axis pulse	XP+ and XP- are differential pair signals of X-axis pulse.
GY04(XP+)	Positive differential signal of X-axis pulse	
GY05(YD-)	Negative differential signal of Y-axis direction	YD+ and YD- are differential pair signals of Y-axis direction.
GY06(YD+)	Positive differential signal of Y-axis direction	
GY07(YP-)	Negative differential signal of Y-axis pulse	YP+ and YP- are differential pair signals of Y-axis pulse.
GY08(YP+)	Positive differential signal of Y-axis pulse	
GY09(ZD-)	Negative differential signal of Z-axis direction	ZD+ and ZD- are differential pair signals of Z axis direction.
GY010(ZD+)	Positive differential signal of Z-axis direction	
GY011(ZP-)	Negative differential signal of Z-axis pulse	ZP+ and ZP- are differential pair signals of Z-axis pulse.
GY012(ZP+)	Positive differential signal of Z-axis pulse	
GY013(SP-)	Spindle reverse rotation control port	
GY014(SP+)	Spindle forward rotation control port	
GY15(S_2)	2 nd gear output port of spindle speed	Multi-gear spindle speed control ports: they can provide at most 8-gear speed control; in wiring, COM at the inverter end needs joining to the GND terminal.
GY16(S_1)	1 st gear output port of spindle speed	
GY17(S_0)	0 th gear output port of spindle speed	
GY18	Workpiece cooling output port	
GY19	Spindle coolant output port	
GY20	Auto lube output port	
+24V OUT	+24V output	For connection with +24V power supply.

Table 2 Input signals

Silk-printed name	Corresponding signal	Remark
GND	Power GND or COM port	The two GND of the power terminal are connected with power GND and the common ground point of the machine tool respectively, while GND of other terminals can be used as COM signals.
+24V IN	+24V DC power input	For external connection with +24V DC power.
GX01(XORG)	Machine origin signal of X-axis	For external connection with mechanical, photoelectric, or proximity switch, etc.
GX02(XLM+)	Positive limit signal of X-axis	
GX03(XLM-)	Negative limit signal of X-axis	
GX04(YORG)	Machine origin signal of Y-axis	
GX05(YLM+)	Positive limit signal of Y-axis	

Silk-printed name	Corresponding signal	Remark
GX06(YLM-)	Negative limit signal of Y-axis	
GX07(ZORG)	Machine origin signal of Z-axis	
GX08(ZLM+)	Positive limit signal of Z-axis	
GX09(ZLM-)	Negative limit signal of Z-axis	
GX10	Reserved input	
GX11	Reserved input	
GX12	Reserved input	
GX13	Reserved input	
GX14	Reserved input	
GX15	E-stop alarm signal input	
GX16	Tool presetter input	

2.2. Input Interface of +24V Power

The +24V power input interface is for external connection with 24V power. And its pin definition is as shown in Fig. 2-2, in which  is connected to the grounding copper plate of a machine tool, namely to the earth.

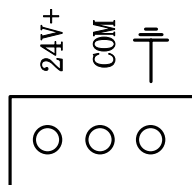

Fig. 2-2 Pin definition of +24V power input interface

2.3. USB Interface

The USB interface is used for externally connecting with USB device (e.g. USB flash drive).

3. Basic Concepts

NK105 system involves various concepts, like workpiece coordinate system (WCS), machine coordinate system (MCS), operation mode, and operation state, etc. You have to grasp these concepts before using NK105.

3.1. Operation Mode and State

3.1.1. Operation Mode

The machine tool is always in one of the following operation modes.

◆ **Auto Mode**

Under automatic operation mode, the machine tool generates motions through the file loaded in advance.

◆ **Manual Mode**

To meet the requirements of manual motion under different situations, the system provides “Jog” and “Stepping” modes.

- Jog mode: there is no concrete data control in this mode, fit for tuning machine coordinates roughly.
- Stepping mode: this mode is applicable to tuning machine coordinates accurately.

3.1.2. Operation State

The machine tool is also always in one of the following operation states; operation mode and operation state together decide the state of the machine tool.

◆ **IDLE State**

Idle state is the most common state. Under this state, the machine has no motion to output, but is ready for any new task.

◆ **ESTOP State**

This is an abnormal state. When there is an error in the hardware of the machine tool, the system will enter into this state and implement the predetermined protection actions, such as closing spindle motor and cooling pump. Under this state, the machine tool is locked and unable to carry out any new action.

◆ **Running State**

When the machine tool is implementing any action, the system enters into “Running” State.

◆ **Pause State**

When the machine tool is running, if the key of “pause during machining” is pressed, the system will enter into PAUSE state and wait for further instruction. At this time, pressing the “Start” key will make the system enter into “Running” state, while pressing the “Stop/Cancel” key will make the system stop.

◆ **LOCK State**

Lock state is an internal state occurring at the time of soft limit operation.

3.2. Coordinate System

Coordinate system is a terminology that is used to describe the motion of a machine tool. For the sake of unification, standard coordinate system adopts the right-hand rule. See Fig. 3-1.

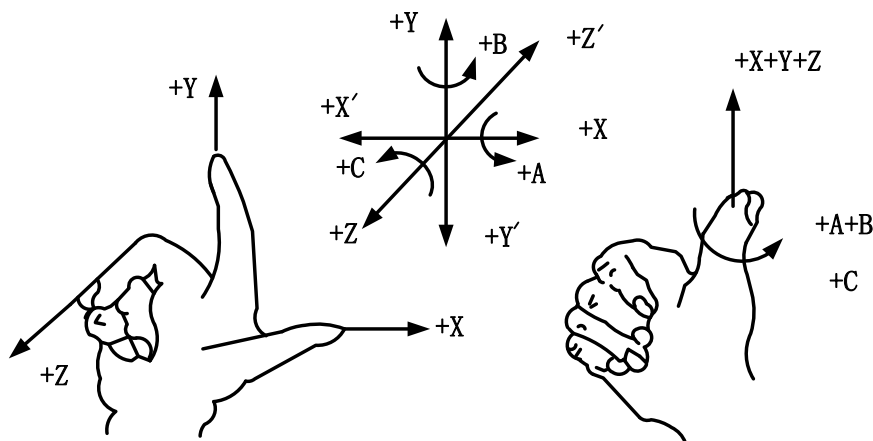

Fig. 3-1 A coordinate system conforming to right-hand rule

For milling machines, the direction of machine axes is decided by both the type of machine tool and the layout of each component. The basic coordinate axes of milling machines are X-axis, Y-axis, and Z-axis:

——Z-axis is coincidental with spindle axis and the direction of the cutter moving away from workpiece is its positive direction (+Z).

——X-axis is perpendicular to Z-axis and parallel to the clamped surface of workpiece. For the single column vertical milling machine, if the user faces the spindle and looks in the column direction, right moving direction is its positive direction (+ X).

——X-axis, Y-axis and Z-axis constitute a coordinate system adhering to the right-hand rule.

3.2.1. Machine Coordinate System

Machine coordinate system is a set of fixed right-hand coordinate system. Its coordinate origin is always fixed with respect to a certain position on the machine tool. Therefore, at any time, a certain point in space can be exclusively fixed by the machine coordinate system.

The machine coordinate system requires the machine available of the homing function, or this concept will only appear in the software.

3.2.2. Workpiece Coordinate System

As a set of right-hand coordinate system for the programmer, workpiece coordinate system is used in programming. To establish it, the programmer can select a given point on the workpiece as the origin (also called program origin). The origin of workpiece coordinate system (namely the workpiece origin) is fixed with respect to a certain point on the workpiece, while variable with respect to the machine origin. The origin of workpiece coordinate system should be selected meeting such conditions as simple programming, easy dimension conversion and small machining errors.

Workpiece offset corresponds to WCS G54, G55, G56, G57, G58 and G59. After the system is opened, the default WCS is G54, and the relation between workpiece offset and machine coordinate system is as shown in Fig. 3-2.

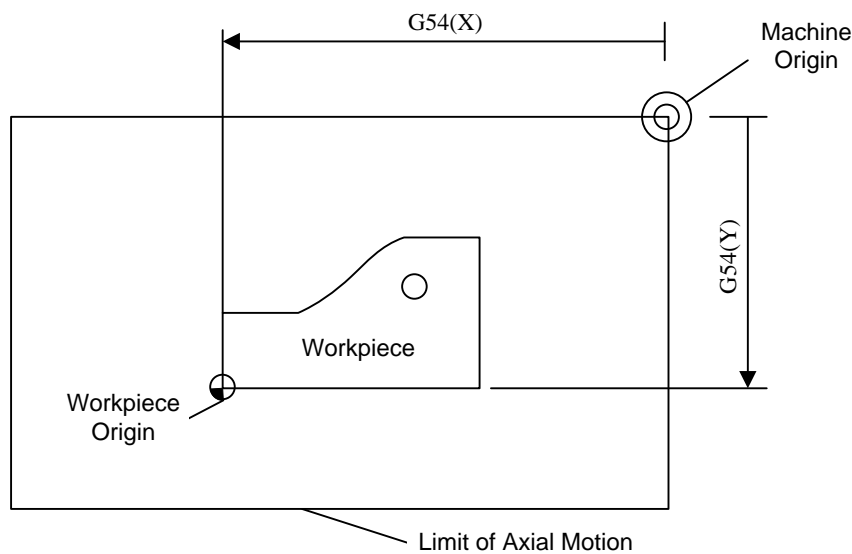

Fig. 3-2 The relation between workpiece offset and machine coordinate system

One, two or several workpiece offsets can be used in one machining program. As shown in Fig. 3-3, three workpieces are installed on the worktable, so each workpiece has a workpiece origin corresponding to the G code of workpiece coordinate system. To drill a hole on each of the workpiece, with calculation depth as Z-0.14, the programming example is as follows.

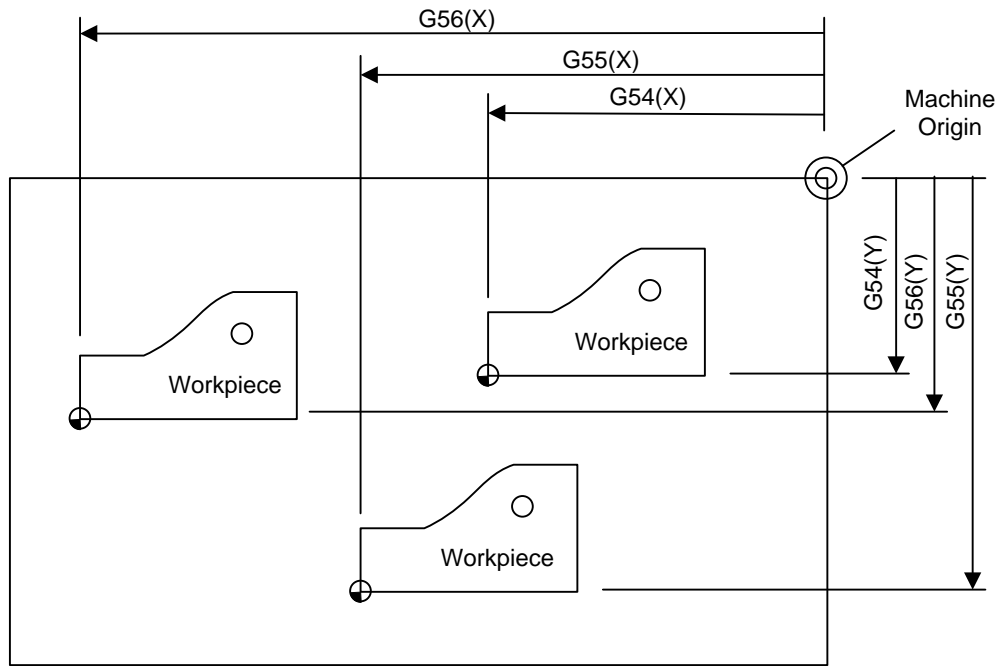

Fig. 3-3 Example figure

```

O1801
N1 G20
N2 G17 G40 G80
N3 G90 G54 G00 X5.5 Y3.1 S1000 M03           (Use G54)
N4 G43 Z0.1 H01 M08
N5 G99 G82 R0.1 Z-0.14 P100 F8.0
N6 G55 X5.5 Y3.1                             (Switch to G55)
N7 G56 X5.5 Y3.1                             (Switch to G56)
N8 G80 Z1.0 M09
N9 G91 G54 G28 Z0 M05                         (Switch to G54)
N10 M01

```

...

Program segments N3~N5 are for the first workpiece, within G54 WCS; program segment N6 drills the hole for the second workpiece of the same batch within G55 WCS; program segment N7 drills the third hole for the third workpiece of the same batch within G56 WCS.

Aiming at all WCSs, public offset is used to adjust the workpiece origin of X, Y and Z axes, without changing the offset value of G54~G59.

The relationship of workpiece offset, tool offset and public offset is illustrated as below:

$$\text{Workpiece coordinate} = \text{Machine coordinate} - \text{Workpiece offset} - \text{Tool offset} - \text{Public offset}$$

4. Functions & Operation Methods of Panel Keys

4.1. NK105G2 Panel Keys

See Fig. 4-1 for the layout of NK105G2 panel keys.

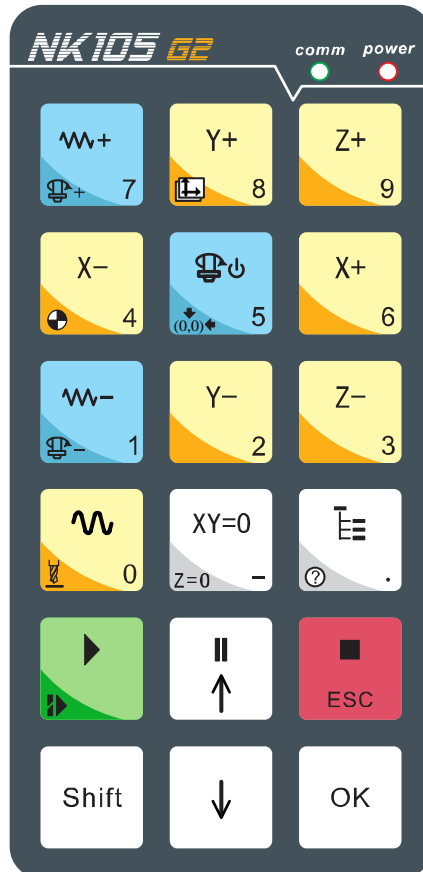







Fig. 4-1 Panel keys of NK105G2

4.1.1. Function Information of Each Single-key

NK105G2 operation panel is both light and concise. With a single-key or combination key, all the operations can be realized. The usage of each single-key is: press a key to complete the called function and then release the key, except that the function of the mode shift key becomes effective when released. See Table 3 for the function information of each single-key.

Table 3 Single-key function table

Key icon	Key name	Function
	Override+	Increase of feedrate override; input of number 7; increase of spindle gear with the help of the auxiliary key when the spindle port has input
	Y+	Positive movement of Y axis; input of number 8; switch between MCS and WCS with the help of the auxiliary key
	Z+	Positive movement of Z axis; input of number 9
	X-	Negative movement of X axis; input of number 4; homing all the axes with the help of the auxiliary key
	Spindle ON/ OFF	Start or stop of spindle in manual mode; input of number 5; backing to workpiece origin with the help of the auxiliary key
	X+	Positive movement of X axis; input of number 6
	Override-	Decrease of feedrate override; input of number 1; decrease of spindle gear with the help of the auxiliary key when the spindle port has input
	Y-	Negative movement of Y axis; input of number 2; first tool measurement with the help of the auxiliary key
	Z-	Negative movement of Z axis; input of number 3; measurement after tool change with the help of the auxiliary key
	Speed switchover	Switchover between jog/rapid jog speed in jog mode; input of number 0; tool measurement with the help of auxiliary key
	Clearing	XY clearing; input of minus; Z clearing with the help of auxiliary key
	Menu	Entering menu page; input of decimal point; entering image update page at the time of system start-up











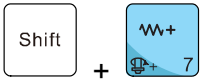

Key icon	Key name	Function
	Start	Start key; breakpoint resume with the help of the auxiliary key
	Up	Suspend processing; up direction key
	ESC	Stop processing; cancellation of various selections, inputs and operations
	Shift	Auxiliary key; switchover between stepping mode and jog mode under machining page
	Down	Down direction key
	OK	Entering jog/rapid jog speed adjustment page under menu page; confirmation of various selections, inputs and operations

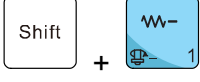
4.1.2. Function Information of Combination Key

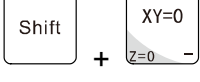
Theoretically, functions of all keys except for “Shift” key and “Menu” key on the panel can be self-defined according to actual situation in NK105G2/G3 system, especially the usage of combination key. The user can find setting files under directory of *Config* folder, file *Key18Config.xaml* corresponding to NK105G2 system, and file *Key28Config.xaml* to NK105G3 system. However, please note that, to avoid the possible confusion caused by modified key function and current panel face, it is strongly recommended not to alter the function definition and combination key arbitrarily. Please contact with the machine tool builder or the developer if it is necessary.

The usage of the combination key: press the auxiliary key, and then the second; release the two keys after the corresponding function is called. The user can press combination key “Shift + Menu key” to preview the whole list of combination key. Please note that the following are combination key by default:

Table 4 Combination key function table

Key icon	Function
Shift + 	Increase of spindle gear
Shift + 	Switchover between WCS and MCS
Shift + 	Homing all the axes
Shift + 	Backing to workpiece origin
Shift + 	Decrease of spindle gear
Shift + 	Moveable tool measurement
Shift + 	Z clearing
Shift + 	Breakpoint resume
Shift + 	Entering help page of combination key
Shift + 	First tool measurement
Shift + 	Measurement after tool change
Shift + 	Jiggle at pause

4.2. NK105G3 Panel Keys

See Fig. 4-2 for the layout of NK105G3 panel keys.

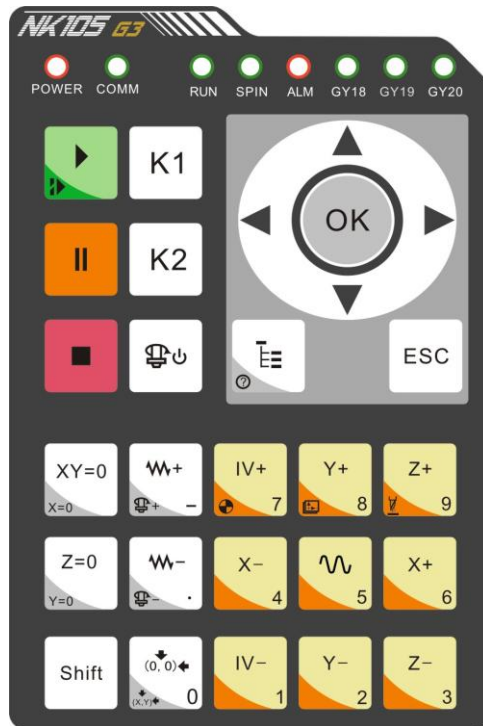





Fig. 4-2 Panel keys of NK105G3

4.2.1. Function Information of Each Single-key

The operation panel of NK105G3 is both light and concise. With a single-key or combination key, all the operations can be realized. The usage of each single-key: press a key lightly to complete the called function and then release the key, except that the function of the mode shift key becomes effective when released. See Table 5 for the function information of each single-key.

Table 5 Single-key function table

Key icon	Key name	Function
	Start	Start key; breakpoint resume with the help of the auxiliary key
	Pause	Pause during machining
	Stop	Stop machining

Key icon	Key name	Function
	Spindle ON/OFF	Start or stop of spindle under manual mode
	Menu	Entering menu page; entering image update page at the time of system start-up; entering help page with the help of the auxiliary key
	ESC	Esc key; returning to the previous page
	XY clearing	XY clearing; X clearing with the help of the auxiliary key
	Z clearing	Z clearing; Y clearing with the help of the auxiliary key
	Shift	Auxiliary key; switchover between stepping mode and jog mode under machining page
	Override+	Increase of feedrate override; increase of spindle gear with the help of the auxiliary key when the spindle port has input
	Override-	Decrease of feedrate override; decrease of spindle gear with the help of the auxiliary key when the spindle port has input
	Back to workpiece origin	XY axes backing to workpiece origin; XY axes backing to fixed point with the help of the auxiliary key; input of number 0
	X-	Negative movement of X axis; input of number 4
	X+	Positive movement of X axis; input of number 6
	Y+	Positive movement of Y axis; input of number 8; switchover between MCS and WCS with the help of the auxiliary key









Key icon	Key name	Function
	Y-	Negative movement of Y axis; input of number 2; first tool measurement with the help of the auxiliary key
	Z+	Positive movement of Z axis; input of number 9; tool measurement executed with the help of the auxiliary key
	Z-	Negative movement of Z axis; input of number 3; measurement after tool change with the help of the auxiliary key
	Speed switchover	Switchover between jog speed and rapid jog speed in jog mode; input of number 5
	Positive	Positive movement of the extended axis; input of number 7; homing all the axes with the help of the auxiliary key
	Negative	Negative movement of the extended axis; input of number 1

4.2.2. Function Information of Combination Key

The usage of the combination key: press the auxiliary key, and then the second; release the two keys after the corresponding function is called.

Table 6 Combination key function table

Key icon	Function
	Breakpoint resume
	entering help page of combination key
	X clearing
	Y clearing

Key icon	Function
Shift + 	Increase of spindle gear
Shift + 	Decrease of spindle gear
Shift + 	XY axes backing to fixed point
Shift + 	homing all the axes
Shift + 	Switchover between MCS and WCS
Shift + 	Moveable tool measurement
Shift + 	Jiggle function
Shift + 	First tool measurement
Shift + 	Measurement after tool change

4.3. Modification Method of System Parameters

Parameters for modification can be divided into two types:

◆ Input of Numeric Value

After entering the parameter modification page, directly input the desired number, and then press [OK] to save it or press [ESC] to return to the previous page. Only when [OK] is pressed can modification be saved. For example: the modification method for the parameter “REFP Speed” is as follows.

Speed (mm/min)	
X Axis:	1800.000
Y Axis:	1800.000
Z Axis:	1500.000

Fig. 4-3 Modification page of “REFP Speed”

Press “Menu”→ 5. Mfr Param→ 5. REF. PointSet→ 1. REFP Speed, and press [OK] to enter the page as Fig. 4-3. Then press “Up” and “Down” keys to select the axis speed parameter to be modified. When the cursor is on an item, enter the new parameter value directly and then press [OK] to save it.



Note: If you switch to another parameter without saving the input value during parameter modification, this new value will not be saved and the original value will be restored.

◆ Selection of Parameter Value

Select the parameter value by directly pressing the “UP” or “Down” key. For example: the modification method for the parameter “REFP Dir” is as follows.

Homing Direction	
X Axis:	Negative
Y Axis:	Positive
Z Axis:	Positive

Fig. 4-4 Modification page of “REFP Dir”

Press “Menu”→ 5. Mfr Param→ 5. REF. PointSet→ 2. REFP Dir, and then press [OK] to enter the page as shown in Fig. 4-4, and then press the “Up” and “Down” keys to select the axis direction parameter to be modified. When the cursor is on an item, press the [OK] key to enter the interface as shown in Fig. 4-5, the arrow indicating the current parameter value. Press [Up] or [Down] key to select the desired parameter value, and then press the [OK] key to confirm the modification.

Direction of X	
·	Positive
▷	Negative

Fig. 4-5 Selection dialog

4.4. System Start-up

The system interface is shown in Fig. 4-6 after power on. After the system is started, “Back to REF.

Point” will be prompted as Fig. 4-7. Press [ESC] to cancel this operation. You need to adjust the following related parameters sequentially: port polarity (see Chapter 5.3), pulse equivalent (see Chapter 5.1.2), axis output direction (see Chapter 5.1.1) and machine stroke (see Chapter 5.2) before homing all axes.

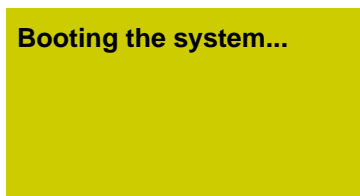

Fig. 4-6 System start-up interface

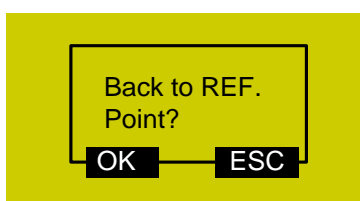

Fig. 4-7 Prompt to home all the axes after system started

5. Machine Tool Debugging

5.1. Adjustment of Axis Direction and Pulse Equivalent

5.1.1. Adjustment of Axis Direction

Firstly confirm the positive direction of each axis according to the coordinate system adhering to the right-hand rule before starting machine debugging.

After fixing the positive direction of each axis following the right-hand rule, manually operate the machine to check if the axes move correctly. If the direction is opposite, modify the parameter “Axis OutpDir”. Take X-axis as an example, manually move the X-axis, only to find it moves oppositely. To solve this problem, you just need to change the value of X axis in the parameter “Axis OutpDir” from “Positive (Negative)” to “Negative (Positive)”.

Press the “Menu” key→ 5. Mfr Param→ 2. Axis OutpDir, and then press the [OK] key to enter the interface as shown below.

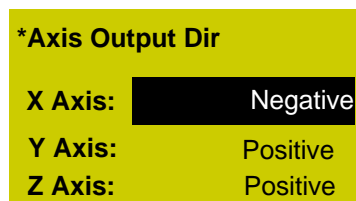
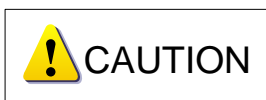

Fig. 5-1 Modification interface of “Axis OutputDir”



The mark “*” in front of a parameter indicates that the modification to this parameter becomes effective after reboot. Modification to a parameter without the mark becomes effective immediately.

5.1.2. Adjustment of Pulse Equivalent

Pulse equivalent is the moving distance of the worktable or rotation degree of the rotary axis per pulse sent by the CNC device, i.e. the minimum distance controlled by the CNC system. This item can be calculated in terms of information of screw pitch, electronic gear ratio, mechanical deceleration ratio, etc.

The smaller the pulse equivalent is, the higher the machining precision and surface quality will be. At the meanwhile, the setting value of pulse equivalent decides the max. feed speed (feed rate), and the relationship between pulse equivalent and max. feed speed is as shown below:

$$\text{Max. feed speed (mm/min)} = \text{Pulse equivalent (mm/p)} \times \text{Hardware frequency (p/s)} \times 60 \text{ (s/min)}$$

The hardware frequency of NK105G2/G3 is 320KHz; when pulse equivalent is 0.001mm/p, the max. feed speed of machine tool is 19.2m/min.

Lower pulse equivalent should be set under the condition of meeting the demand of feed speed.

◆ Pulse Equivalent of Linear Axis

The calculation of pulse equivalent varies with different motor systems.

➤ Stepping motor

$$\text{Pulse equivalent} = \frac{\text{Screw pitch}}{\frac{360}{\text{Stepping angle}} \times \text{Subdivision} \times \text{Mechanical deceleration ratio}}$$

Hereinto, mechanical deceleration ratio = rotary speed input in reducer / rotary speed output = teeth number of driven gear / teeth number of driving gear.

For instance, the selected screw lead of X-axis for a certain type machine tool is 5mm, and the stepping angle of stepping motor is 1.8°, with “10” subdivision and “1:1” deceleration ratio. Thus, the pulse equivalent of X-axis is:

$$\text{Pulse Equivalent} = \frac{5\text{mm}}{\frac{360}{1.8} \times 10 \times 1} = 0.0025\text{mm/p}$$

➤ Servo motor

$$\text{Electronic gear ratio} \frac{B}{A} = \frac{\text{Encoder resolution}}{\frac{\text{Screw pitch}}{\text{Pulse equivalent}}} \times \text{Mechanical deceleration ratio}$$

Electronic gear ratio: if a servo motor makes one circle per every 5000 pulse commands sent by the system, setting electronic gear ratio of the servo motor can make the servo rotate twice with the same amount of pulse commands (please refer to parameter setting of each servo brand).

Please see the servo motor label plate and then refer to the corresponding manual to confirm its encoder resolution. A label plate of YASKAWA SGMSH type motor is as shown below, and the 4th character in motor type is the serial encoder specification, so the resolution of this motor is 2^{17} , i.e. 131072.

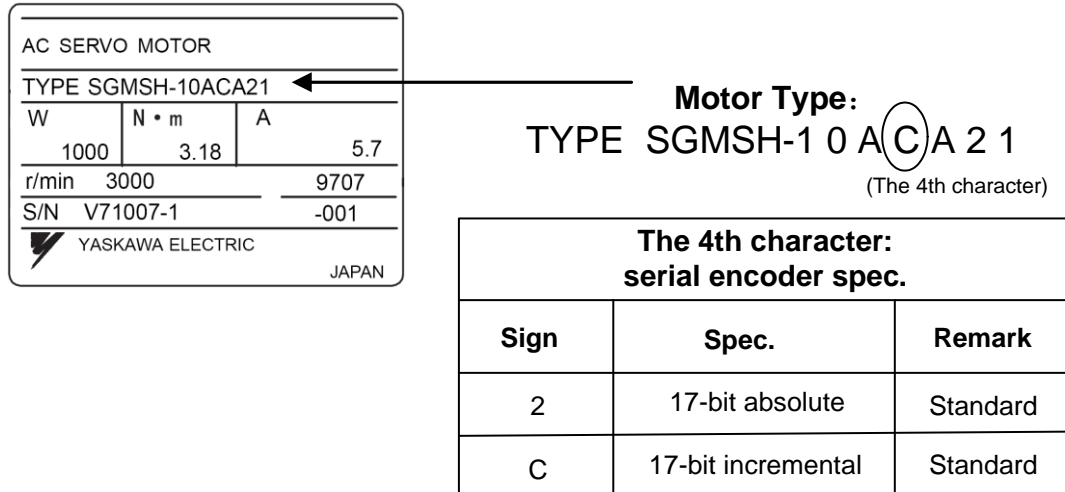

Fig. 5-2 Name plate of servo motor-encoder resolution

For instance: (an example of YASKAWA) the screw pitch of a certain type machine is 5mm, with 17 bit encoder resolution, “0.0001mm/p” pulse equivalent and “1:1” deceleration ratio.

$$\text{Electronic gear ratio} \frac{PN202}{PN203} = \frac{2^{17}}{5/0.0001} \times 1 = \frac{131072}{5/0.0001} \times 1 = \frac{8192}{3125}$$

◆ **Pulse Equivalent of Rotary Axis**

The pulse equivalent of rotary axis refers to the rotation degree of the axis clamping the workpiece per pulse. The rotary degree of workpiece per revolution of motor is equal to screw pitch.

➤ **Stepping motor**

$$\text{Pulse equivalent} = \frac{360}{\frac{360}{\text{Stepping angle}} \times \text{Subdivision} \times \text{Mechanical deceleration ratio}}$$

➤ **Servo motor**

$$\text{Electronic gear ratio} \frac{B}{A} = \frac{\text{Encoder resolution} \times \text{Pulse equivalent}}{360} \times \text{Mechanical deceleration ratio}$$

5.2. Setup of Machine Stroke

Machine stroke refers to the valid motion stroke of a machine tool. In the parameter “MachineStrok”, the valid motion range of the three axes (X/Y/Z) can be set. Because this system regards the machine tool dimensions as the reference for soft limit, their values should be consistent with the actual dimensions of the machine tool. Otherwise, limit overrun or axis crash may occur.

If file machining range exceeds the machine tool’s dimensions, there will be a message box prompting machining is out of range, as shown in Fig. 5-3. You can press [OK] or [ESC] to return to the main page, and then manually move the machine tool to release limit.

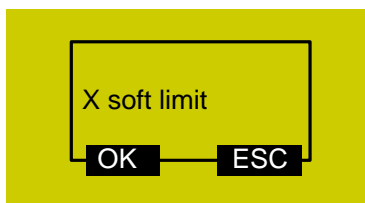

Fig. 5-3 Soft limit prompt

Modification to this parameter becomes valid after system reboot.

5.3. Port Polarity

The polarities of input/ output ports in the software are specified in terms of the switch type: the polarity of a normally closed switch is “P”; the polarity of a normally open switch is “N”. The corresponding relation between system port No. and ports on the terminal board is as shown in Table 7 and Table 8.

The steps to modify port polarity are as following: press “Menu”→ 8. Diagnosis→ 2. Port List, and then press [OK] to enter the interface as shown in Fig. 5-4. At this time, you can press the “Up” or “Down” key to move the cursor to the desired port, and then press the “Shift” key to change its polarity. After its polarity change, press [OK] to save the modification.

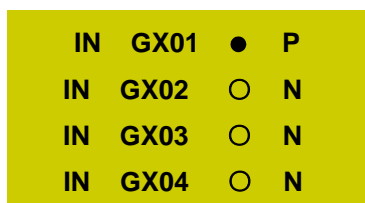

Fig. 5-4 Modification interface of port polarity

Table 7 Corresponding signals of system input ports

System port No.	Terminal name	Corresponding signal	Remark
0	GX01(XORG)	Machine origin signal of X axis	For external connection with mechanical, photoelectrical or proximity switch.
1	GX02(XLM+)	Positive limit signal of X axis	
2	GX03(XLM-)	Negative limit signal of X axis	
3	GX04(YORG)	Machine origin signal of Y axis	
4	GX05(YLM+)	Positive limit signal of Y axis	
5	GX06(YLM-)	Negative limit signal of Y axis	
6	GX07(ZORG)	Machine origin signal of Z axis	
7	GX08(ZLM+)	Positive limit signal of Z axis	
8	GX09(ZLM-)	Negative limit signal of Z axis	
9	GX10	Extended input	
A	GX11	Extended input	
B	GX12	Extended input	
C	GX13	Extended input	
D	GX14	Extended input	

System port No.	Terminal name	Corresponding signal	Remark
E	GX15	E-stop alarm signal	External connection with E-stop button on the machine tool
F	GX16	Tool presetter signal	

Table 8 Corresponding signals of system output ports

System port No.	Terminal name	Corresponding signal	Remark
0	GY013(SP-)	Spindle reverse rotation	Multi-gear spindle speed control ports: they can provide at most 8-gear speed control; in wiring, COM at the inverter end needs joining to the GND terminal.
1	GY014(SP+)	Spindle forward rotation	
2	GY15(S_2)	2 nd gear output port of spindle speed	
3	GY16(S_1)	1 st gear output port of spindle speed	
4	GY17(S_0)	0 th gear output port of spindle speed	
5	GY18	Workpiece cooling	
6	GY19	Spindle coolant	
7	GY20	Auto lube	

5.4. Back to Machine Origin

Origin of Machine Coordinate System (the inherent coordinate system of a machine tool), also called machine origin, mechanical zero, or home, is fixed after design, manufacturing and debugging before the machine tool leaving factory. Only after backing to machine origin can such operations as soft limit, setting fixed point and tool change be enabled. Therefore, after startup of CNC system, it is necessary to home all the axes. This system will remind to back to machine origin after start-up.

If homing can't be executed due to home switch fault, it is necessary to set the parameter "Back REF First" to "No".

5.4.1. Parameter Setup of Backing to Machine Origin

The parameter "REF. PointSet" includes the setting of "REFP Speed", "REFP Dir" and "Retract Dist".

Press "Menu"→ 5. Mfr Param→ 5. REF. PointSet, and then press the [OK] key to enter the setting interface of backing to machine origin, in which press the "Up" or "Down" key to select the corresponding parameter to be modified.

- "REFP Speed": it is the speed of rough positioning during backing to machine origin, i.e. the motion speed of an axis towards the home switch during rough positioning. The value of this parameter should be set in accordance with the integral structure of a machine tool. And too fast

speed can cause missing steps, damage to the machine tool or to the home switch due to axis crash.

- “REFP Dir”: it is the direction of rough positioning during backing to machine origin, i.e. the motion direction of an axis towards the home switch during rough positioning (also known as coarse positioning). This parameter is decided by the motor direction and installation position of the home switch; at the same time, it is also related with the defined attribute of the input level and the attribute of the home switch.
- “Retract Dist”: this parameter is decided by the machine tool itself. After arriving at the machine origin, the machine tool will move some distance away from the machine origin to get out of the signal sensitive zone of the home switch. Its value is recommended as half of the screw pitch.

5.4.2. Operation Mode of Backing to Machine origin

After system start-up, pressing [OK] in the dialog box shown in Fig. 5-5 will home all the axes.

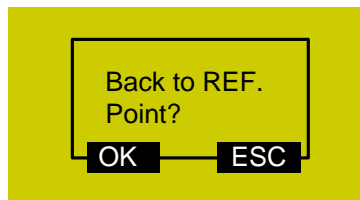

Fig. 5-5 Prompt dialog box of backing to machine origin

This method can only home all the axes. If you want to execute single axis backing to machine origin, refer to the following steps.

Press the “Menu” key→ 3. Operations→ 1. Back REF Point, and then press the [OK] key to enter the setup interface of backing to machine origin, in which press the “Up” or “Down” key to select the desired mode. And then press the [OK] key to execute backing to machine origin in the selected way. It is recommended to execute “Z Home” firstly. If “X Home” or “Y Home” is executed firstly, a message as shown below will be displayed on the LCD prompting to execute “Z Home” firstly. To see all the information, press the “Up” and “Down” keys.

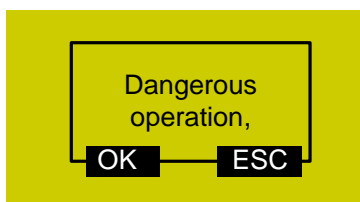

Fig. 5-6 Dangerous prompt for operation of backing to machine origin

At this time, you can press the [OK] key to enter the machining page and execute backing to machine origin for the selected axis, or press [ESC] to cancel and return to the previous page.

5.5. Spindle Debugging

This system can control spindle motor through parameters of “Spindle Gears”, “ON/OFF Delay”, “Initial Gear” and “Max. Spdl Speed”. Spindle speed can also be changed during machining under the condition that the interface board and inverter have been well connected.

5.5.1. Spindle Setup

Press the “Menu” key→ 5. Mfr Param→ 6. Spindle Set, and then press the [OK] key to enter the spindle setup interface, in which press the “Up” or “Down” key to select the corresponding parameter for modification.

◆ Spindle Gears

Currently, 8 gears are supported.

◆ ON/OFF Delay

Since it takes some time for the spindle to reach the rated rotary speed or stop completely, tool damage or a scrap may happen if machining starts before the spindle reaching the rated rotary speed or other actions are performed before the spindle stopping completely. This parameter set the delay time for the spindle to reach the set spindle speed or stop completely when turned ON or OFF.

◆ Initial Gear

It sets the default gear when the spindle started, and its value should be smaller than the total gear number of the spindle. Otherwise, the input value is invalid. If the input value of “Spindle Gears” is smaller than that of “Initial Gear”, the setup is not effective, either.

Modification to this parameter becomes effective after reboot.

◆ Max. Spdl Speed

It refers to the max. rotary speed of the spindle; its value is consistent with the setting of inverter.

Modification to this parameter becomes effective after reboot.

5.5.2. Park MCS Site

Press the “Menu” key→ 3. Operations→ 5. Park MCS Site, and then press the [OK] key to enter the interface of “Park Mode” and “Park Site”, as shown in Fig. 5-7. The position of the spindle after the end of machining can be set here.

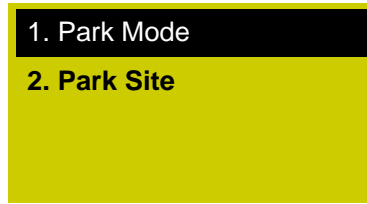

Fig. 5-7 Park MCS site interface

Select “Park Mode”, and then press [OK] to enter the interface as shown below.

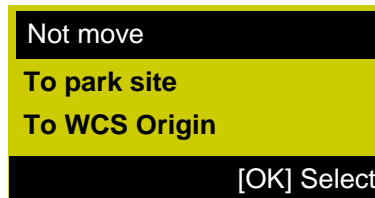

Fig. 5-8 Park mode selection

Press the “Up” or “Down” key to select the desired item, and then press the [OK] key to accomplish the selection and return to the previous page. If “To park site” is selected and confirmed, input or select the park site under “2. Park Site”.

After selecting “Select Site”, press the [OK] key, and then press [OK] again to set current position as the park position. The system will then back to the main page automatically. At this time, you can press the “Start” key to start machining directly.



Current position cannot be set under “Select Site”; you need to set the current position of the spindle in advance.

5.5.3. Spindle Stop

Press the “Menu” key→ 4. Oper Param→ 10. SpindleStop, and then press the [OK] key to enter the setting interface of “Spindle Stop”, in which press the “Up” or “Down” key to select the corresponding parameter for modification. See Fig. 5-9 for the three modes of spindle stop.

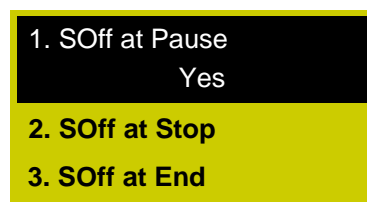

Fig. 5-9 Spindle stop setting interface

5.6. Manual Machining

Manual machining refers to manipulating a machine tool by the direction keys of the three axes on the panel. At the same time, the operation speed and step length, etc. can also be adjusted according

to the requirements of operation.

After backing to the reference point, the system will enter into the manual state automatically, the screen display as shown in Fig. 5-10.

1X	0.000	Idle
1Y	0.000	SOff
1Z	0.000	Slow
Jog		100%

Fig. 5-10 Manual machining interface



Chapters 5.6, 5.7 and 5.8 are the machining operations of NK105G2, while Chapter 7 introduces the machining operations of NK105G3 in details.

5.6.1. Mode Selection of Manual Machining

To satisfy the requirements of manual motion under different situations, this system provides two kinds of manual motion modes: “Jog” and “Stepping”, which can be switched by pressing the “Shift” key. The current motion mode is displayed at the bottom of the LCD.

◆ Jog Motion Mode

There is no concrete data control under this mode. You can press an axis direction key (,

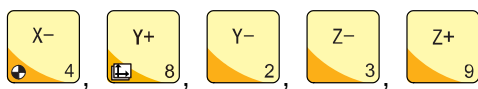

) to move the machine tool accordingly under this mode. The machine tool will not stop until the direction key is released. For the motion speed, it is decided by the current type of speed (jog speed and rapid jog speed). This motion mode is suitable for coarse tuning of the position of machine coordinate.

◆ Stepping Motion Mode

Under this motion mode, the machine tool will move accordingly after an axis direction key (,

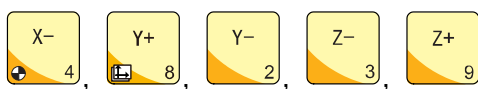

) is pressed. This motion mode is suitable for fine tuning of the position of machine coordinate.

5.6.2. Parameter Setting of Manual Machining

Basic parameters of manual machining include: rapid jog speed (i.e. “High” shown in the machining page), jog speed (i.e. “Slow” shown in the machining page), XY step and Z step.

Table 9 Parameters for manual machining

Parameter	Meaning	Setting range
MSpd (High)	Two types of speed under manual machining, deciding the axis motion speed during manual machining.	0.06~Max. speed of machine tool
MSpd (Slow)		0.06~Rapid jog speed
Step XYZ	The motion distance of the corresponding axis each time an axis direction key of X/Y/Z is pressed.	0.001~10000mm

The max. speed of a machine tool is related with the setting of pulse equivalent. For the concrete expression, see Chapter 5.1.2.

Jog speed (Slow) and rapid jog speed (High) are switched by pressing .

The concept of stepping (also called gridding in some other systems) is introduced for the accuracy of machining and debugging. When the system is in the stepping mode, step is the motion distance of the corresponding axis each time an axis direction key of X/Y/Z is pressed.

Under the main page, press the [OK] key to enter the parameter setting page of manual machining, as shown in Fig. 5-11.

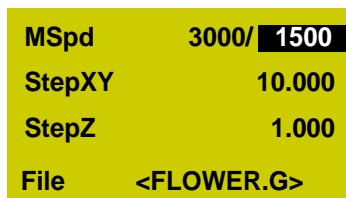

Fig. 5-11 Manual parameter setting page

Press “Up” or “Down” to select the desired parameter, and then press [OK] for confirmation after modification. Note that modification should be within the parameter range.

Current file name is displayed at the bottom of the LCD. Press “Up” or “Down” to move the cursor to the file name, and then press [OK] to enter the file list of C disk, as shown in Fig. 5-12. You can only load these files, unable to delete or copy them under this page.

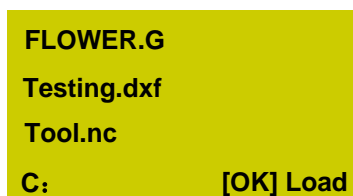



Fig. 5-12 File list page

If there is no file in the C disk, the prompt “File Not Found, Show USB File?” will be displayed;

press [OK] to enter the file list of USB flash drive.

To switch between USB file list and C file list, press .

5.7. Automatic Machining

Automatic machining refers to that the system processes system files and the files in the USB flash drive in terms of instructions, also called file machining. All the parameters of the machine tool and the system should be set correctly before automatic machining starts.

5.7.1. Load File

◆ Load an Ordinary File

Press “Menu” to enter the menu page→ press the “Up” and “Down” keys to select “Local Files” or “USB Files”→ press [OK] to enter the corresponding file list page→ press [OK] to select the desired

machining file→ press  to load the selected file.

◆ Load an ENG File with Tool Selection Function

Find the desired ENG file following the steps above-mentioned to load an ordinary file, and then

press [OK] to select the ENG file to be machined, and then press  to automatically enter the tool selection page as shown in Fig. 5-13.

Number of tools: 2
Tool No.: 0
Cutter 1: [Flat Bottom]JD-6.00

Fig. 5-13 Tool selection page

Number of tools: the number of tools in this ENG file

Tool No.: current tool No., selected by pressing the “Up” and “Down” keys

Cutter: selected by pressing the “Up” and “Down” keys, displaying tool sequence number and name

After parameters are set, press [OK] to load the file; after loading, the system will return to the machining page automatically.

5.7.2. WCS Selection



WCS and MCS are switched by pressing the combination key  + . And their screen display is as shown in Fig. 5-14.



Fig. 5-14 Screen display of WCS and MCS

Number 1~6 in front of X/Y/Z in WCS indicates G54~G59 respectively, while there is no number before X/Y/Z in MCS. A sign * will appear next to each axis in MCS after the completion of backing to machine origin.

Press the “Menu” key→ 3. Operations→ 6. Select WCS, and then press [OK] to enter the setup page, in which press the “Up” and “Down” keys to select the desired WCS. After selection, the contents in the main page will change accordingly. For instance, after “G55 WCS” is selected, the number in front of each axis will change to 2, as shown in Fig. 5-15.

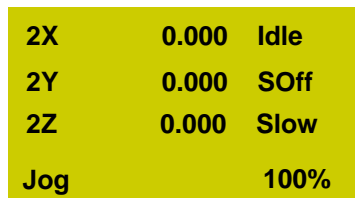





Fig. 5-15 Main page under WCS G55



5.7.3. Set Workpiece Origin

Workpiece origin is the zero of X, Y, and Z in the machining file. Before machining, you must set workpiece origin to determine its actual position.

Manually move the X and Y axes to the desired origin position, and then press  for XY clearing, i.e. to confirm the position of XY workpiece origin.

For Z workpiece origin, there are two ways to set it:

- Method one is the same as that to set XY workpiece origin. Manually move Z axis to the desired origin position. And then press  +  for Z clearing, i.e. to confirm the position of Z axis workpiece origin.

- Method two takes advantages of tool measurement. Press  +  to execute moveable tool measurement. After measurement completed, the coordinate of Z axis is Z workpiece origin.

5.7.4. Start Machining



Press the start key  to start automatic machining in the machining page.

Prompts like feedrate override and feed rate are scrolled on the LCD during file machining.

In addition, during auto processing, pressing the OK key in the main page will display machining info, including loaded program name, processing line number, total line number and elapsed processing time.

5.8. Adjustment during Automatic Machining



5.8.1. Feedrate Override Adjustment

Feedrate override can be increased or decreased through  or  during machining.





The feed rate changes with the feedrate override. Their relationship is as follows:

$$\text{Actual feed rate} = \text{Feed rate} \times \text{Feedrate override}$$

The least unit of feedrate override is 0.1. Namely, override increases (decreases) by 0.1 after

each press of  or ; at the same time, the feedrate override displayed on the LCD increases (decreases) by 10%. The range of feedrate override is within 0%~120%. In addition, the display of feed rate value changes with the feedrate override.



5.8.2. Spindle Speed Adjustment

Spindle speed are adjusted by pressing  +  or  + , and divided into 8 gears from S0~S7 with speed increasing sequentially.

5.8.3. Machining Pause and Jiggle

If machining is found not in position exactly, suspend the machining and then execute manual jiggle. Jiggle is only effective in pause status of auto mode. Suspend machining by pressing the “Pause” key in machining, “Paus” displayed at the top right corner of the LCD while the machine tool stopping moving; as for the spindle, whether it stops or not is decided by the setting of the parameter “SOFF at Pause”. Whether the spindle stops or not, at this time, the three axes can be jigged. Each press of an axis direction key will make the corresponding axis move a specified step.

The operation steps as follows:

- 1) Press  in the process of machining, and then press  +  to enter the jiggle page.
- 2) Press “↑” or “↓” to select a step size from “0.01”, “0.02”, “0.05”, “0.10”, “0.20”, “0.50” and “1.00”.
- 3) Press one of “4”, “6”, “2”, “8”, “3” and “9” to execute jiggle on desired axis in corresponding direction.
- 4) Press “Start” to resume machining after jiggle.



If hard limit, soft limit or E-stop occurs in jiggle, the system will stop jiggle, give a limit prompt or an alarm, and return to the main page.

5.8.4. Continuing Machining after Pause

When the system is in the state of pause, pressing the start key  will continue machining from the pause position, running status at the top right corner of the screen changing from “Pause” to “Run”; at the same time, the machine tool continues machining.

5.8.5. Soft Limit Handling

Soft limit occurs when an axis exceeds the setting range of “MachineStroke” during machining, and the system will display a limit dialog as shown below.

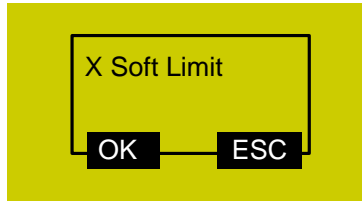

Fig. 5-16 Soft limit dialog

Press [OK] or [ESC] to exit from this warning dialog and return to the machining page, and then manually move the limit axis towards the reverse direction to release limit. After soft limit occurs, the system prohibits the limit axis from moving towards the limit direction.

5.8.6. Hard Limit Handling

The system detects hard limit periodically under the main page. When hard limit occurs, its prompt dialog is as shown in Fig. 5-17.

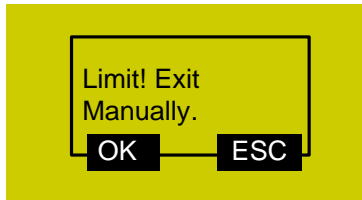

Fig. 5-17 Hard limit dialog

At this time, press [OK] to return to the main page under “Jog” mode, with “Limit Rls.” displayed at the bottom right corner of the LCD, as shown in Fig. 5-18. Or you can press [ESC] to directly back to the main page under “Jog” mode.

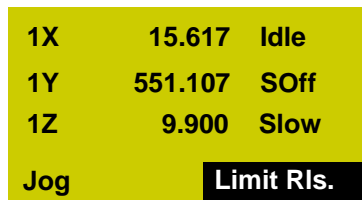

Fig. 5-18 Prompt interface of limit release

Move the machine tool away from the limit position, “Limit Rls.” disappearing. The main page returns to its normal state.

6. Menu Page

6.1. Summarization

After start-up, the system is in manual mode and machining page by default. The machining page displays info like axes, coordinate value, operation state, spindle state, type of manual speed and machining mode. See Fig. 6-1.

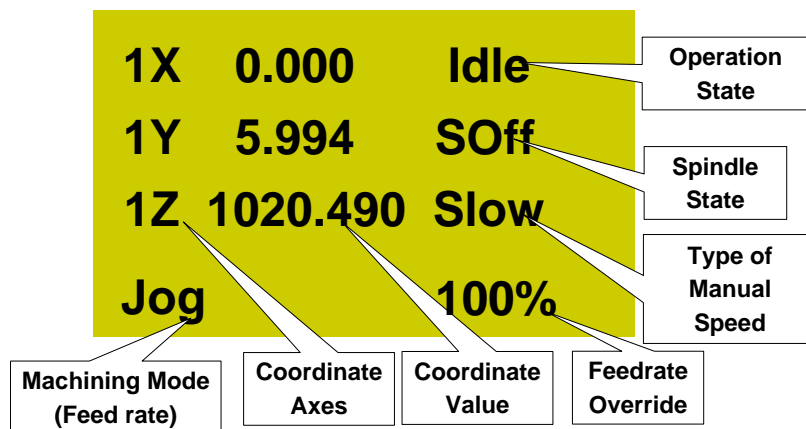

Fig. 6-1 Machining page

◆ Machining Mode

It is comprised of jog and stepping modes, which can be switched by pressing



◆ Coordinate Axes

Machine coordinate system (MCS) and workpiece coordinate system (WCS) are included, and

are switched by pressing the combination key + . The system in Fig. 6-1 is in WCS, and the number 1~6 before X/Y/Z axis indicates WCS from G54 to G59 respectively. For MCS, there is no number before X/Y/Z axis. After homing is accomplished, a sign * will be displayed after the corresponding axis in MCS.





◆ Operation State

Operation state includes idle, E-stop, running, pause and lock states.





◆ Spindle State

It indicates the current spindle gear and spindle ON/OFF. In idle state, spindle is turned ON or

OFF by pressing . In machining state, spindle gear is increased or decreased by pressing

 +  or  + . 1S represents the 1st-gear rotary speed, 2S the 2nd-gear rotary speed, and nS the nth-gear rotary speed.



For NK105G3, in idle state, spindle is turned ON or OFF by pressing ; in machining state, spindle gear is increased or decreased by pressing  +  or  + .

◆ Type of Manual Speed

Manual speed is divided into two types: rapid jog speed (High) and jog speed (Slow), which are

switched by pressing . Refer to Chapter 5.6.2 for the speed setting method.



For NK105G3, rapid jog speed and jog speed are switched by pressing .

◆ Menu Page

Press  to enter the menu page. There are altogether 8 parameter items in the menu but the LCD can only show 4 of them at a time, as shown in Fig. 6-2.

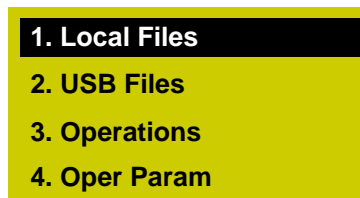

Fig. 6-2 Menu page

Press “Up” and “Down” keys to select the desired item and then press [OK] key to enter the corresponding sub-menu.



In NK105G3, you can also press the "right" key to enter the sub menu, or the "left" key to access the parent menu.

6.2. Local Files/ USB Files

See Fig. 6-3 for the interface, in which load, delete, and copy operations can be carried out. In addition, the system supports file folders, identified by the mark "▶". You can move the cursor onto the desired file folder, and then press "OK" to enter the file folder and load/copy/delete the desired file. Remember that only one file can be loaded to the system at a time. If several files are selected simultaneously, a prompt dialog will appear in loading.

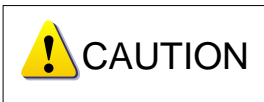

After is pressed to execute "③Copy", a dialog box will pop up asking for confirmation; press [OK] to start copying; if the file is large, the system page will display "Copy Progress..."; wait patiently and do not press any key on the operation panel until copy completed.

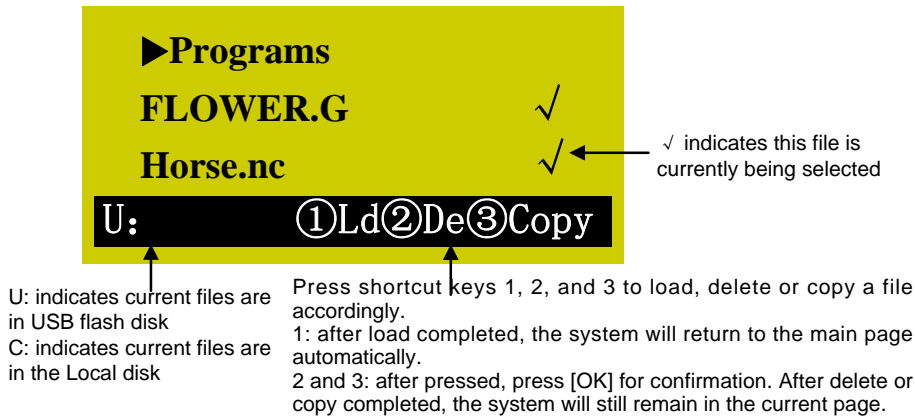

Fig. 6-3 File list page

6.3. Operations

The sub-menus under [Operations] are as shown in Fig. 6-4.

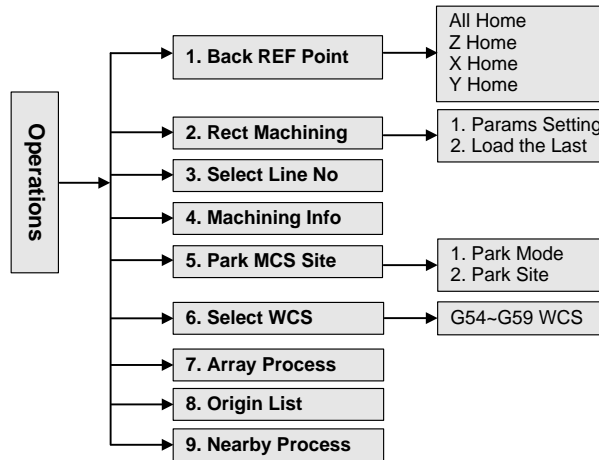

Fig. 6-4 Submenus under [Operations]

Press the “Menu” key→3. Operations, and then press [OK] to enter its page, in which select the desired menu item by the “Up” or “Down” key. Fig. 6-5 is the [Operations] page.

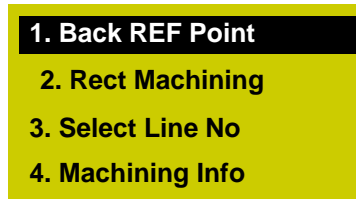

Fig. 6-5 [Operations] page

6.3.1. Back REF Point

For details, see Chapter 5.4.

6.3.2. Rect Machining

The system offers rectangle milling wizard; after setting parameters successfully, press the “Up” and “Down” keys to select [Load Now], and then press [OK] to load the machining file; and then you

can press  to start machining.

You can also select “2. Load the Last”, and then press [OK] to load the last rectangle milling and

return to the machining page, and then press  to start machining.

Parameters “X Init” and “Y Init” decide the initial position of machining plane; “Height” and “Width” decides the size of machining plane; two kinds of machining mode are available: “Horiz. Mill” (the feed direction of tool is parallel to X axis) and “Long. Mill” (the feed direction of tool is parallel to Y axis);

“EachDpth” is the tool machining depth each time; generally, the value of “EngrDpth” (the total depth of several millings) is set bigger than that of “EachDpth”; if the value of “EachDpth” is equal to or bigger than that of “EngrDpth”, only one milling will finish the machining; “NoseGap” means the distance between two adjacent lines, whose value should be set smaller than that of “ToolDia” to avoid missing millings.



- 1) After setting parameters and moving the cursor to “Load Now”, you still need to press [OK] to load the machining file.
- 2) If the input value of “EngrDpth” is too big, the system will send the warning information “Too many file layers generated, continue?”, as shown in Fig. 6-6. You can press [ESC] to back to modify the value; or press [OK] to load the file anyway, the system staying in the page shown in Fig. 6-6. At this time, if you press a key, its function will not be executed until this dialog box disappears, so it is not allowed to press any key under this state. You can wait patiently until the file is successfully loaded, or you can power off and re-power on the system.

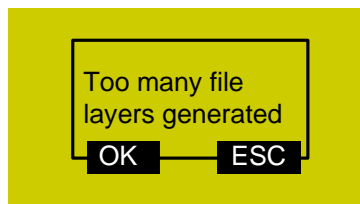

Fig. 6-6 Warning dialog when parameters not properly set

6.3.3. Select Line No

This page shows the loaded file information, like total line No., start line No. and end line No. The default setting of “StartLine” is the breakpoint position of the current file, and “EndLine” the last line. With this function, you can select any blocks to be processed. After these values are set, press the “Up” or “Down” key to select “Execute Now”, and then press [OK] to start machining instantly.



The default line No. of “StartLine” is the breakpoint line No. under this page.

6.3.4. Machining Info

After this item is selected and [OK] is pressed, the system will analyze the file currently loaded automatically, like calculating the needed time for file machining and the machining range of each axis. The page of analytic result is as shown in Fig. 6-7.

Time: 0: 1: 42		
X :	108	205
Y :	20	117
Z :	0	5

Fig. 6-7 Analytic result of Machining Info

6.3.5. Park MCS Site

For details, refer to Chapter 5.5.2.

6.3.6. Select WCS

Press “Menu”→ 3. Operations→ 6. Select WCS, and then press [OK] to enter the page shown in Fig. 6-8, displaying the 6 WCSs from G54 to G59.

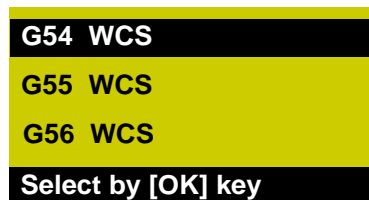

Fig. 6-8 WCS selection page

After pressing the “Up” and “Down” keys to select the corresponding WCS, press [OK] to confirm the selection. After confirmation, the number before X/Y/Z axis will change accordingly, WCSs of G54~G59 corresponding to 1~6 respectively.

6.3.7. Array Process

Array machining (array process), i.e. array machining of graphics, is available in NK105G2/G3. After selecting a file and specifying rows, columns and row/ column space, press “Load Now” to generate and load the array file. Before starting machining, you can turn to “Machining Info” under “Operations” to see the machining range of the array file. Operation steps as follows:

Menu→ Operations→ Array Process→ Load the desired single-workpiece machining file, and set parameters like Rows, Columns, RowSpace, ColSpace and Delay→ Select Load Now and press OK→ Press Start to start array machining. The array file generated can be found under the source file path.



- 1) This function is only available for tool path files of text format, like txt, nc and u00.
- 2) Codes, like G92, M17 and G65, and #variables, like #1 and #2, cannot appear in the tool path file.
- 3) Codes, like M30, M2 and M1, when included in the tool path file, will be removed automatically from the newly generated array file.

4) Call of a sub-program in the PUBLIC is not allowed in the tool path file.

6.3.8. Origin List

Press “Menu”→ 3. Operations→ 8. Origin List, and then press [OK] to enter the origin list page. To save workpiece origin, the operation steps are as follows:

If the current position is desired to save as workpiece origin, press the corresponding shortcut key to set it as workpiece origin→ turn to the origin list page→ move the cursor to one of the 8 items and press “OK”→ press the number key “1” to save the current position as workpiece origin.



- 1) Before saving, loading or deleting workpiece origin in the origin list page, press “OK” to confirm the selected item.
- 2) The number key 1 is for saving workpiece origin, 2 for loading, and 3 for deleting. If workpiece origin saved in one of the 8 items is loaded, it will be set as the current workpiece origin.

6.3.9. Nearby Process

NK105G2/G3 supports machining from proximal point. In case of insufficient machining, you can manually move the spindle nearby, and then execute “Nearby Process” to resume machining from the machining point nearest to the current spindle position.

6.4. Oper Param (Operator Parameters)

◆ Parameters Related with Velocity

Parameter	Meaning	Setting range
G00 Speed	G00 speed, which can be set in this parameter or in the program file	Related with the specific machine tool G00 speed < Max. velocity of machine tool
Gxx Speed	Gxx speed	Related with the specific machine tool

The max. velocity of a machine tool is related with the setting of pulse equivalent. For the detailed expression, see Chapter 5.1.2. The relation between actual feed rate and feedrate override is:

$$\text{Actual feed rate} = \text{Feed rate} \times \text{Feedrate override}$$

Jog speed and rapid jog speed are set in the manual speed setup page; G00 speed ≥ machining speed, and rapid jog speed ≥ jog speed > 0.06

◆ Parameters Related with Machining

Parameter	Meaning	Setting range
Back REF First	Whether homing all the axes before machining required or not	Yes: Required No: Not required
Lifts on Pause	Lifting amount at pause	0~10000 mm
G73_G83Retract	Retract or spacing amount of G73_G83 command	0~1000000 mm
Ratio ON Manu	Manual Feedrate affected by override	Yes: Affected No: Not affected
CycleProcess		
Cycle Process	Whether to enable cycle process	Yes: Enabled No: Disabled
Cycle Times	Cycle machining times, valid when "Cycle Process" is set to "Yes"	1~9999
Cycle Interval	Interval between two adjacent cycles	0~3600000
S_Off in Intev	Whether to stop spindle in the interval	Yes: Stop No: Not stop
G73_G83Retract	Retract or spacing amount of G73_G83 command	0~1000000 mm
<p>Homing all the axes before machining can prevent machining deviation and ensure position accuracy. It is recommended to set "Back REF First" to "Yes" to disable a machine tool to run automatically if backing to machine origin is not executed before machining. When the home switch cannot work normally, "Back REF First" can be set to "No".</p> <p>G73_G83Retract: the retract amount after each feed under G73 command; under G83 command, the distance between the feed plane where the cutter changes from G00 to Gxx and the previous peck depth.</p>		

◆ Parameters Related with Offset

Parameter	Meaning	Setting range
PublicOffset	Aiming at all the WCSs, used for adjusting workpiece origin of X, Y and Z axes	-10000~10000 mm
Work Offset	D-value of WCS origin and MCS origin	-10000~10000 mm
<p>The relation of workpiece offset, tool offset and public offset is as following: Workpiece coordinate = Machine coordinate - Workpiece offset – Tool offset – Public offset</p>		

◆ Spindle Parameters

Parameter	Meaning	Setting range
SpindleStop		
SOff at pause	Whether to stop spindle at pause	Yes: Stop; No: Not stop
SOff at Stop	Whether to stop spindle at stop	Yes: Stop; No: Not stop
SOff at End	Whether to stop spindle when machining completed	Yes: Stop; No: Not stop
ProcessEndTip	Whether to turn on the red light indicator as a sign of the completion of machining	Yes: On; No: Off

Parameter	Meaning	Setting range
This group of parameters sets whether to stop spindle under various forms of stop state.		

◆ File Parameters

Parameter	Meaning	Setting range
Dxf Params		
Lifting Height	It sets the tool lifting height of Z axis during rapid traverse when a DXF file is being processed.	0~99999 mm
Process Depth	It specifies the machining depth for 2D files.	-99999~0 mm
1st Point as 0	It sets whether to set the first point as workpiece origin when a DXF file is processed.	Yes: Valid; No: Invalid
Shape Process	The system will not process the next shape until the current shape is finished.	Yes: Valid; No: Invalid
Bottom Process	Valve operation is enabled only when [3D cutting] is on the workpiece surface.	Yes: Valid; No: Invalid
Metric Size	It forcibly sets a dxf file using metric size.	Yes: Metric size No: Imperial size
Eng Params		
Lifting Height	It sets the tool lifting height of Z axis during rapid traverse when an ENG file is being processed.	0~99999 mm
ToolChangeTip	It sets whether to pause and prompt tool change when tool change command is encountered during ENG file machining.	Yes: Valid; No: Invalid
Cycle Times	It sets the cycle times to process an Eng file.	0~100000
Deep Hole Mode	Mode selection for deep hole machining	0: Reciprocating chip removal; 1: High-speed reciprocating chip removal
Retract Amount	Retract amount after each feed in high-speed reciprocating chip removal mode	0~99999999 mm
Select ToolNo.	If this parameter is set to "Yes", the machining will be executed in terms of the specified tool No. in the machining file and only this file will be processed.	Yes: Valid; No: Invalid
Plt Params		
Lifting Height	It sets the tool lifting height of Z axis during rapid traverse when a PLT file is being processed.	0~99999 mm
Plt Unit	Normally, 1plt=40.195mm, which can be enlarged or diminished by setting this parameter.	0.001~99999
Tool step	The value should be confirmed in terms of the tool diameter and make the adjacent tool paths overlap for a full machining.	0.0001~99999 mm

Parameter	Meaning	Setting range
Processing Depth	It specifies the machining depth for 2D files.	-99999~0 mm
<p>DXF parameters are for the translation of DXF files. In DXF file machining, the system treats the action of tool lifting as the separate mark for the adjacent shapes, If there is no tool lifting, the system will consider only one shape is being processed. If tool lifting occurs, it indicates the machining of a complete shape is finished. For example, process several circles adjacent to each other. The depth of each circle is 10mm, and each feed depth of Z axis is 2mm. If the parameter "Shape Process" is set to "Yes", the machine tool will process the current circle 5 times, and then lift the tool, and then go to process the next circle. If it is set to "No", the machine tool will process the current circle once, then lift the tool, and then go to process the next circle. After all the circles are processed once, this process will be re-executed 4 times to finish machining all the shapes.</p> <p>ENG parameters are for the translation of ENG files.</p> <p>PLT parameters are for the translation of PLT files. PLT is a format of 2D machining files defined by an American company—Hewlett Packard (HP), usually used in embossment and advertising carving. At the same time, PLT is also a kind of unit. Normally, 1plt=40.195mm, which can be enlarged or diminished by setting the parameter "PLT Unit".</p>		

◆ Tool Change Parameters

Parameter	Meaning	Setting range
Tool Change		
ATC Capacity	Capacity of tool magazine	1~20
Current ToolNo.	Tool No. currently used	1~Value of ATC Capacity
Tool Offset	Modification to the tool offset along each axis	X/Y/Z: -10000~10000 mm
ToolChangeTip	Whether to send prompt when there is tool change command in the file	Yes: Valid; No: Invalid
X/Y/Z Cali Coord	The machine coordinate (X/Y/Z) of tool presetter in fixed tool measurement	/
CaliToolHeigh	The required tool lifting height after the end of tool measurement	0.001~9999 mm

◆ Ignore Command

Parameter	Meaning	Setting range
Ignore F Code	Whether to enable the feedrate command in the machining file	Yes: Enable the feed rate in the system No: Enable the feed rate in the machining file
Ignore S Code	Whether to enable the spindle command in machining file. When the parameter is set to "No", speed	Yes: Enable the spindle command in

	specified by S command in the file belongs to which gear, then the speed of the gear will be enabled as the current spindle speed, instead of the speed specified by the S command directly.	the system No: Enable the spindle command in the machining file
--	--	--

6.5. Mfr Param (Manufacturer Parameters)

◆ Velocity Parameters

Parameter	Meaning	Setting range
Decel. Dist.	To protect tools, the machine tool will decelerate (at [Approach Speed]) when approaching the target position during positioning. This parameter is used to specify the distance from the decelerating position to the target position.	0~999mm
Approach Speed	It is the feed speed of the tool when approaching workpiece during positioning (the distance between the tool and workpiece is smaller than deceleration distance).	Jump speed ~ Machining speed
Sgl Axis Acc.	Description of the acceleration/ deceleration capability of each feed axis, in "mm/s ² "	0.001~100000.0mm/s ²
Max. Turn Acc.	The max. acceleration of feed motion on adjacent axes	0.001~100000.0 mm/s ²
Jerk	The change rate of acceleration of single axis (acceleration's acceleration)	0.001~100000.0 mm/s ³
Max. Feedrate	To set the maximum speed of X,Y,Z axes	0~Maximum machining speed
ShortSegSpdLmt	Whether to enable speed limit for short segments	Yes: Valid; No: Invalid
SpdLmt Length	The max. length of short segments	0.001~100000mm
Z Down Option	The mode of Z axis downward cut	0: Not disposed 1: Only Z axis 2: XYZ synchronization
Z PlungeCutSpd	The downward cut speed of Z axis under G01 downward cut	0~Max. Speed of Z axis
Ref Cir Radius	See below for explanation.	0.001~100000.0 mm
Ref Cir. Speed	Reference circle is the reference for the machining of circular workpiece. The max. speed of reference circle refers to the max. speed of machine in machining this circle without obvious vibration.	Min. speed of arc machining ~ Machining speed
Jump Speed	The max. speed for the stepper motor at start-up without acceleration	[Approach Speed]~Machining speed

After the installation of a machine tool, you can make the machine process a circle, in which vibration will occur due to centrifugal force. The higher the speed is, the stronger the vibration will

Parameter	Meaning	Setting range
	<p>be. Gradually increase the feed speed to see the state of vibration of the machine tool until the max. circular speed is achieved, i.e. the max. speed of the machine tool without strong vibration. This circle is regarded as the reference circle, and its max. speed is the max. speed of reference circle. Max. centripetal acceleration “a” can be calculated in terms of the reference circle radius and its max speed. The formula is as follows: V_0 and R_0 are the speed and radius of the reference circle respectively, while V_x and R_x are the speed and radius of an arc to be processed. After R_x is confirmed, when the arc machining speed is larger than V_x calculated, the system will limit the arc machining speed automatically to ensure it is within the debugging value, i.e. the vibration will not be stronger than that during ex-factory debugging.</p> $a = \frac{V_0^2}{R_0} = \frac{V_x^2}{R_x}$	

◆ Parameters Related with Machine Tool Debugging

Parameter	Meaning	Setting range
Axis OutpDir	The motion direction of each axis	Positive; Negative
MachineStroke	The valid motion stroke of a machine tool, i.e. the valid machining range of a machine tool in X/Y/Z axis	Set according to the actual machine tool
ChangeToolStroke	The upper and lower limit of machine coordinates of X/Y/Z axes in changing tool.	Upper limit setting range: lower limit~67108.864; Lower limit setting range: -67108.864~67104.864.
Pulse Equiv.	The worktable stoke per pulse sent by the CNC device or the rotary degree of a rotary axis, i.e. the least distance the CNC system can control	0.00009~999.0 mm/p
REF. PointSet		
REFP Speed	The speed of rough positioning in backing to machine origin	0.001~Max. speed of machine tool
REFP Dir	The direction of rough positioning in backing to machine origin	Positive; Negative
Retract Dist	The additional motion distance after fine positioning stage in backing to machine origin, to move out of the machine origin signal sensitive zone	0~10000 mm
Sign of BK REF	Whether to eliminate the sign of backing to machine origin after E-stop	Yes: Eliminate No: Not eliminate



If you can ensure that the axis position will not deviate after E-stop, you can set the parameter “Sign of BK

REF” to “No”, so you can continue machining without backing to machine origin after E-stop is obviated. Otherwise, you need to set this parameter to “Yes” to ensure machining accuracy.

◆ **Spindle Parameters**

Parameter	Meaning	Setting range
Spindle Set		
Spindle Gears	Spindle speed is divided into several gears.	1~8
ON/OFF Delay	The wait time for the spindle to reach normal rotary speed or stop completely after turned ON or OFF	0~60000 ms
Initial Gear	Initial speed gear	1~[Spindle Gears]
Max. Spdl Speed	Max. spindle speed	Spindle speed~999999 mm/min

◆ **Y Rotaryaxis**

Parameter	Meaning	Setting range
Y AsRotaryAxis	Whether Y axis is set as rotary axis	Yes: Valid; No: Invalid
Rotary Y Pulse	The pulse equivalent of Y axis when it is set as rotary axis	0~100 mm/p
mm As Unit	It sets the measure unit for the rotary axis.	Yes: in mm No: in deg
Rev. WorkRadius	The length of Y axis in CAM programming is the value of workpiece radius $\times 2 \times \pi$. The value of this parameter changes with the radius of workpiece.	0~1000000mm
Rotary Takeoff	The takeoff speed of the rotary axis	0~1000000 mm/s
Rotary Y Acc.	The acceleration of the rotary axis, with unit as rad/s^2	0.001~100000.0 rad/s^2
Max. RotaryVel.	Max. rotary speed	0.06~6000000 r/min

◆ **Lubrication Setting**

Parameter	Meaning	Setting range
Lube		
EnableAutoLube	Whether to open lubrication pump automatically at fixed period	Yes: Valid No: Invalid
Time Interval	Time interval between two adjacent lubes	0~34560000 s
Duration	Duration time to release lubrication oil each time	0~34560000 s

◆ **Parameters Related with Algorithm**

Parameter	Meaning	Setting range
Enable S Algo	Whether to adopt S-type algorithm	Yes: Valid; No: Invalid

Parameter	Meaning	Setting range
Arc Increment	Whether to adopt arc increment mode In arc increment mode, the coordinates of the circle centre are relative to the starting point. Otherwise, they are relative to workpiece origin.	Yes: Valid; No: Invalid
Forward LookSeg	Used to set the max. look-ahead segments when calculating connection speed	0~10000
ARadiusToleranc	In the IJK incremental representation of G02 and G03, the circle radius is calculated twice. Generally, the two values calculated are not the same and their D-value is called arc radius tolerance. Typically, arc instruction does not incur too large tolerance, and the recommended value is about 0.01mm.	0.001~Max. speed of machine tool
Look Ahead Dis	The system looks ahead a certain distance to analyze and calculate path interpolation.	0~999mm



The parameter “Look Ahead Dis” is only available in NK105G3.

◆ Compensation Parameters

Parameter	Meaning	Setting range
Backlash Set		
Screw Error Compensation	Whether to enable screw error compensation	Yes: Valid; No: Invalid
EnableBacklash	Whether to enable backlash compensation	Yes: Valid; No: Invalid
AxisBacklash	The backlash compensation amount of X, Y and Z axes, valid only when “CompensationOn” is set to “Yes”	0~1000000 mm
Please refer to chapter 6.6.6 for more details about the compensation types. Note: for one machining task, only one compensation method can be enabled at a time. To put it in other words, when compensation is necessary, either screw error or backlash compensation can be enabled at one time.		

◆ Other Operations

Parameter	Meaning	Setting range
Smoothing Time	The larger the value is, the smoother the workpiece surface will be, but too large value will affect the dimension of workpiece. 0.01 is recommended for a mold machine, and 0.03 for a	0.0~0.064 ms

Parameter	Meaning	Setting range
	woodworking machine.	
G00 Feed 100%	Whether to enable 100% feedrate override for G00	Yes: Valid; No: Invalid
Safety Height	Calculated with respect to workpiece origin. The horizontal movement at this height is considered to be safe, used in breakpoint resume and backing to workpiece origin.	0~5000 mm
CalibThickness	The thickness of the tool presetter	0~Worktable range
Corner Option	The type of corner smooth	0: Not disposed 1: Curve 2: Arc
Corner Toler	For the integral smoothness of workpiece, the tool may not arrive at the specified position accurately at the connection of each two program segments. When the difference between the tool position and the specified position is equal to the value of this parameter, the system regards the end of the current program segment machining.	0.0~0.1
Setting Contro	Whether to enable 1.5ms control cycle	Yes: Enable No: Disable

6.6. Param Upkeep (Parameter Maintenance)

Press the “Menu” key→ 6. Param Upkeep, and then press [OK] to enter the page, in which select a submenu by pressing the “Up” and “Down” keys.

The submenus under this page are as shown in Fig. 6-9.

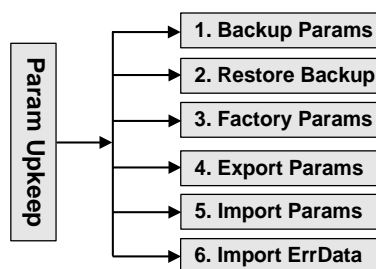

Fig. 6-9 Submenu list of parameter upkeep

6.6.1. Backup Params

Press [OK] to confirm backing up the parameters. No matter whether the parameter backup is successful or failed, a prompt will be displayed.

6.6.2. Restore Backup

It is used to restore the backup parameters. If the parameters have not been backed up, “Backup

File Not Found!” will be displayed.

If the recovery is successful, a prompt of rebooting the system will be displayed, as shown in Fig. 6-10. At this time, you can press [OK] to reboot the system directly, or [ECS] to return to the previous page.

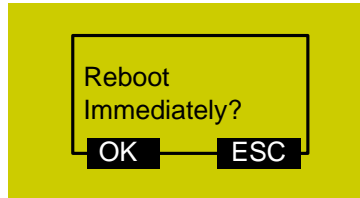

Fig. 6-10 Prompt dialog of system reboot

6.6.3. Factory Params

The action of ex-factory parameter recovery is to clear all the data and parameters interiorly set stored in the system memory chip. It is necessary to perform this action when there are messy codes in the interior file or after upgrade finishes.

Operate following the prompts displayed on the screen. After recovery is successful, a cue to reboot the system will be displayed on the screen, as shown in Fig. 6-10. At this time, you can press [OK] to restart the system, or [ESC] to back to the previous page.

The action of ex-factory parameter recovery won't clear the parameters backup file. Therefore, if this action is carried out accidentally and all the interior parameters are cleared, you can restore the backup parameters by “Restore Backup”.



Modification to this item will not become effective until the system is rebooted.

6.6.4. Export Parameters

In case of software or hardware fault, you can export parameters to an USB flash drive for backup.

6.6.5. Import Parameters

Import the parameters in the USB flash drive to the system, avoiding repeatedly setting parameters. After import is successful, the system will display a prompt of system reboot as shown in Fig. 6-11.

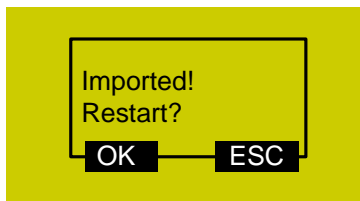

Fig. 6-11 Prompt dialog of successful parameter import

6.6.6. Import Error Data

Import the compensation file in the USB flash drive to the system. The system will compensate automatically according to the imported file in machining.

Screw error consists of screw pitch error and errors caused by backlash. Generally, there is no need to compensate above two errors. However, in high precision required situation, compensation for backlash is necessary, and for higher precision requirement, both error compensations are needed.

◆ Pitch Compensation

Pitch error is caused by screw defect and long-term wear, etc. In order to improve precision, pitch compensation is needed to meet the requirement. The sketch of a screw is shown in Fig. 6-12 (A). A coordinate system is established, based on “0” point on the screw as the reference point, nominal value as X-coordinate, and actual value as Y-coordinate. Then the ideal moving curve is as curve “1” in Fig. 6-12 (B), however, the actual curve will be curve “2” due to pitch error. That is to say, the Actual value is not the same as its corresponding Nominal value or the actual moving curve is deviating from the ideal one. We call their difference error, i.e.:

$$\text{Error} = \text{Nominal machine coordinate} - \text{Actual machine coordinate}$$

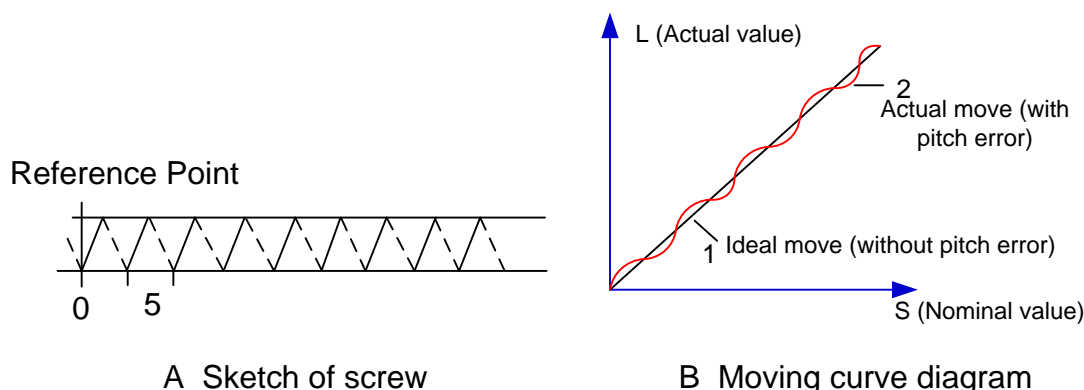

Fig. 6-12 Analysis of pitch error

In pitch compensation, generally pitch error value is irrelevant to feed direction. That is, when the pitch is too small in positive feed, additional pulse is needed, and thus, when negative feed passes the same position, the same amount of feed pulse should be added. But if the pitch is too large, deduction of pulse is needed, and neither is the reducing amount related to feed direction. In software

compensation, correction of each point on the error curve should be tabulated and saved to the system memory. Then auto compensation for coordinates of each point is available in running, so as to improve machine precision.

◆ **Backlash Compensation**

Hysteresis caused by forward and reverse clearance. Assume that driving shaft drives driven shaft in negative (CW) rotation, servo motor will be idling without moving worktable because of mechanical driving chain backlash, when the driving shaft suddenly begins CCW rotation (positive motion). After staying at a certain position for some time, the worktable will move backward with the driving shaft. The same situation will occur when the direction of the driving shaft changes again. We call it Hysteresis. If pitch error doesn't exist, namely under ideal condition, the moving curve of worktable is shown in Fig. 6-13 (A), in which the horizontal section is the curve without worktable movement during the idling of servo motor. The actual moving curve of worktable is shown in Fig. 6-13 (B).

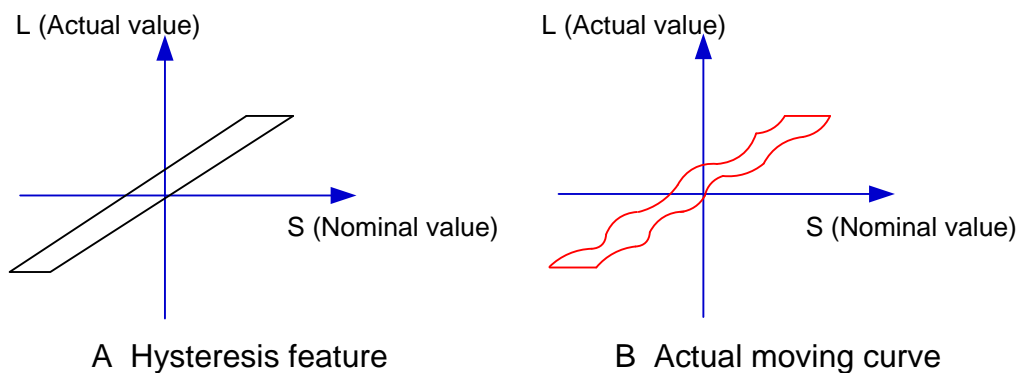

Fig. 6-13 Analysis of backlash

To put it in a simply way: because spindle is generally fixed on the screw whose outer wire and the inner wire on the outer wire cannot be completely matched, the spindle needs to finish the screw clearance in the last direction when reversing its moving direction. The compensation for the clearance is called backlash compensation.

➤ **Measuring Method and Compensation Method**

Backlash can be measured by a specialized gauge. Firstly, fix the gauge besides the spindle and turn its pointer to the zero position. Secondly, manually move the spindle “a” mm in one direction and move reversely the same “a” mm. Read the result of gauge, namely the actual moving distance “b” mm, and calculate the backlash, (a-b) mm.

Input and set the obtained compensation value to the parameter “AxisBacklash”.

◆ **Screw Error Compensation File**

Actually the system has already combined the above two errors (screw pitch error and backlash)

to deal with and will execute error compensation automatically based on the error data in the file after the backward error and forward error of the corresponding nominal coordinate of each coordinate axis are listed into the screw error compensation file.

The name of the screw error compensation file is *axeserr.dat*.

The file format is:

- 1) Firstly specify length unit, currently the supported length unit is mm and the style of writing is:
unit = mm
- 2) Then specify error sequence of each axis. To work properly, the contents in this sequence must be in the ascending order of nominal machine coordinate value. See as below:

```
[Axis Name]
<Nominal Machine Coordinate>, < Forward Error>, < Backward Error>
<Nominal Machine Coordinate>, < Forward Error >, < Backward Error >
<Nominal Machine Coordinate>, < Forward Error >, < Backward Error >
```

For [Axis Name]: X/Y/Z...(letters in upper case and lower case are the same)

Nominal Machine Coordinate: It is the machine coordinate with a sign with respect to reference point, which is calculated by the given pitch and pulse equivalent (i.e. the length calculated based on the nominal pitch, not on the physical one), arranged in ascending order. Nominal machine coordinate must be within the stroke range, or the compensation is invalid.

Backward Error: The error generated by the motion towards decreasing direction of coordinate value.

Forward Error: The error generated by the motion towards growing direction of coordinate value.



Pay special attention to the sign of nominal machine coordinate and actual machine coordinate, especially when equipment like laser interferometer is used to measure the length. Calculate after the measured length is converted to the corresponding machine coordinates, or a wrong result may occur.

- 3) Annotation: it must be in a separate line and started with a semicolon. Its syntax is:

<Annotation contents>

Note that a **semicolon** must be the first character of the separate line, that is, no other character should be in front of the semicolon, even blank space.

Example of screw error compensation file format---Common cases:

```
;unit=mm
[X]
-570.025,      0.027,      0.083
-450.020,      0.025,      0.077
```

```
-330.015,      0.015,      0.068
-210.010,      0.000,      0.057
```

Example of screw error compensation file format--A certain axis only needs backlash compensation

```
;unit=mm
[Y]
0.000,      0.000,      0.030
1000.00,    0.000,      0.030
```

◆ **Compensation Method**

Generally, screw error compensation error can be measured by the gauge, laser interferometer. Manually input the value into the compensation file as the file format introduced above after it has been obtained.

Save the modified compensation file under the root directory of USB flash driver, and insert the USB into NK105 control box, then import the file into the system. After the compensation file imported successfully, the system will automatically make compensation according to the file in machining.

6.7. System Upkeep

Press “Menu”→ 7. System Upkeep, and then press [OK] to enter its page, in which select a submenu by pressing the “Up” and “Down” keys. The submenus under this page are shown in Fig. 6-14.

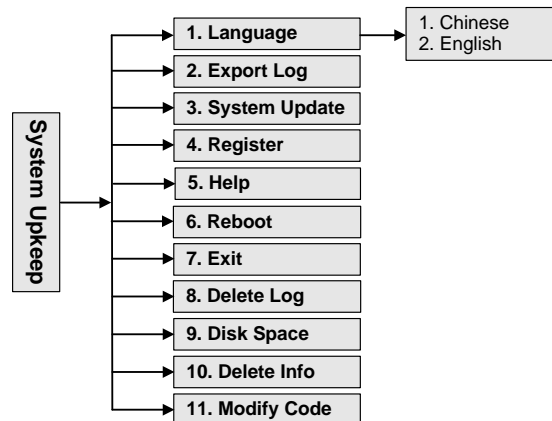

Fig. 6-14 Submenu list of system upkeep

6.7.1. Language

Currently, the system supports two kinds of language: Chinese and English, which can be switched in the following page.



Fig. 6-15 Chinese-English selection page

6.7.2. Export Log

A *Log.txt* will be generated after the log is exported to an USB flash drive. After log export finishes, “Log Exported Successfully” will be displayed on the screen. Press [OK] or [ESC] to return to the previous page.

6.7.3. System Update

After the cursor is on the “System Update” item, press [OK] for confirmation, after which a dialog will pop up asking whether to update the system. After [OK] is pressed again, a dialog as shown in Fig. 6-16 will pop up.

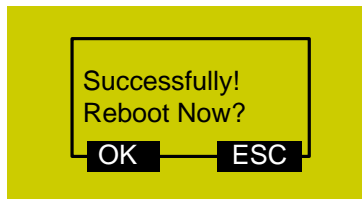

Fig. 6-16 Prompt dialog after successful system update

Press [OK] to reboot the system. After the system displays “USB Available Now!”, press [OK] to enter the system update page, as shown in Fig. 6-17.

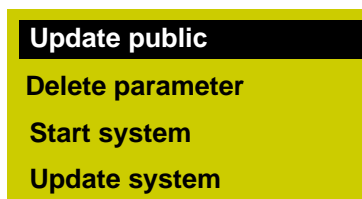

Fig. 6-17 System update page

Select a corresponding operation in this page by pressing the “Up” and “Down” keys. “Update public” is to update the *Public.dat* file; “Delete parameter” is to delete the configuration file in BOOT, which must be executed before “Update system”; “Start system” is to start the original system without upgrading it; “Update system” means deleting the original system and upgrading the system by the new application file in the USB flash drive. Refer to Chapter 9 for the details of system update.

At this time, you can select “Start system” and then press [OK] to exit from system update page, or select “Update system” and then press [OK] to exit from system update page and enter the machining page by booting the new system.

◆ Export Backup

The software will be exported to the USB flash drive for backup, with its backup folder named *Backup*.

◆ Import Parameter

This menu item is used to import the parameter file (file name: *Settings.dat*) in the USB flash drive into the system. Generally, the parameter file is under the root directory of the USB flash drive. If it is not in the root directory, search for it in the *Backup* folder.

◆ Version number

It is used to view the version number of BOOT loader.

6.7.4. Register

Move the cursor to “4. Register”, and then press [OK] to enter registration code input page, as shown in Fig. 6-18.

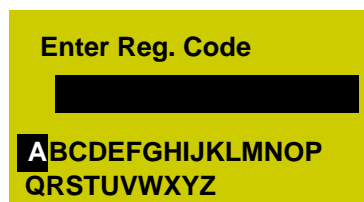

Fig. 6-18 Registration code input page

Register by entering the registration code in this page. Select a letter (end-around) by pressing the “Up” and “Down” keys, and then press [OK] for conformation; for the input of a number, press the corresponding number key.

6.7.5. Help

After the cursor is on the item “5. Help”, press [OK] to enter the “Help Message Show Delay” parameter setting page as shown in Fig. 6-19. The value of this parameter is an integer within the range of 1~999999.

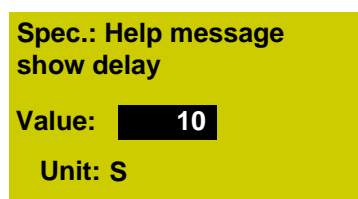

Fig. 6-19 Help setting page

6.7.6. Reboot

After the cursor is on this item, press [OK] to eject its dialog box asking “Sure To Reboot System”,

press [OK] to reboot the system.

6.7.7. Exit

After the cursor is on this item, pressing [OK] will eject a dialog box, in which pressing [OK] will exit from the system. And then the LCD goes blank. If you want to enter the system again, you need to power off and re-power the system.

6.7.8. Delete Log

After the cursor is on this item, pressing [OK] will eject a dialog box, in which pressing [OK] will delete the system log.

6.7.9. Disk Space

The menu item is used for viewing the capacity and used space of the system disk.

6.7.10. Delete Info

This menu item is used for clearing temporary files in the system to release space.

6.7.11. Modify Code

This menu item is used for changing manufacturer password.

6.8. Diagnosis

Press “Menu”→ 8. Diagnosis, and then press [OK] to enter its page, in which select a submenu by pressing the “Up” the “Down” keys.

The submenus under this page are as shown in Fig. 6-20.

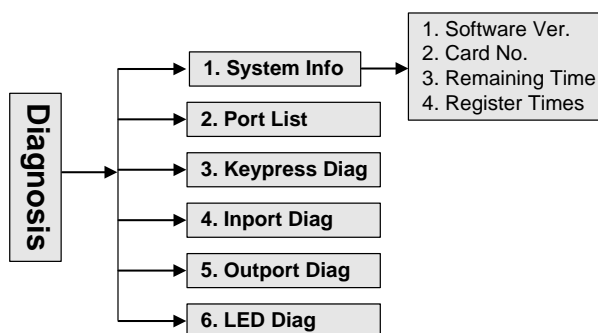

Fig. 6-20 Submenu list of system diagnosis



LED diagnosis is only available in NK105G3.

6.8.1. System Info

In this page, you can view the software version, control card No., remaining time and registered times. If an item is wrong, after pressing [OK] for confirmation, an error prompt “Failed to Read Registration Info” will be displayed. At the same time, the other items cannot be read, either.

6.8.2. Ports List

For details, see Chapter 5.3.

6.8.3. Keypress Diag

This menu item is used to check whether panel keys work normally. After entering the test page, the system will display a prompt “Press a key”. Pressing any key at this time will show the name of the pressed key on the screen, as shown in Fig. 6-21. If the pressed key is damaged and out of work, the screen will not display its name or the wrong key name. Pressing “ESC” will exit from this page.

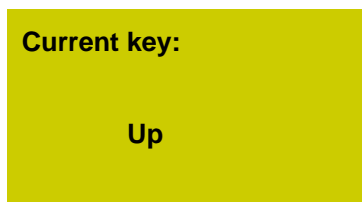

Fig. 6-21 Keypress diagnosis page

6.8.4. Inport Diag

This page is only for viewing the polarities of the input ports, instead of changing them.

6.8.5. Outport Diag

This page is only for viewing the polarities of the output ports displayed by running lights, instead of changing them. The corresponding relation among system output terminal No., terminal board ports and signals is listed in Chapter 5.3 Port Polarity.

6.8.6. LED Diag

This page is only for checking the work conditions of the LEDs on the NK105G3 handheld box.

In the LED diagnosis page, press F1. If the LEDs work regularly, all the LEDs become light.

7. Machining Operations of NK105G3

7.1. Manual Machining

Manual machining refers to manipulating a machine tool by the direction keys of the three axes on the panel. At the same time, the operation speed and step length, etc. can also be adjusted according to the requirements of operation.

After backing to the reference point, the system will enter into the manual state automatically, the screen display as shown in Fig. 7-1.







1X	0.000	Idle
1Y	0.000	SOff
1Z	0.000	Slow
Jog		100%

Fig. 7-1 Manual machining interface







7.1.1. Mode Selection of Manual Machining

To satisfy the requirements of manual motion under different situations, this system provides two kinds of manual motion modes: “Jog” and “Stepping”, which can be switched by pressing the “Shift” key. The current motion mode is displayed at the bottom of the LCD. For the setup of step, jog speed and rapid jog speed, press [OK] under the machining page to enter the setup interface.

◆ Jog Motion Mode

There is no concrete data control under this mode. You can press an axis direction key (, , , , , ) to move the machine tool accordingly under this mode. The machine tool will not stop until the direction key is released. For the motion speed, it is decided by the current type of speed (jog speed and rapid jog speed). This motion mode is suitable for coarse tuning of the position of machine coordinate.

◆ Stepping Motion Mode

Under this motion mode, the machine tool will move accordingly after an axis direction key is pressed (, , , , , ). Each time an axis direction key is pressed down, the machine tool will move the set step in the corresponding direction. This motion mode is suitable for fine tuning of the position of machine coordinate.

7.1.2. Parameter Setting of Manual Machining

Basic parameters of manual machining include: rapid jog speed (i.e. “High” shown in the machining page), jog speed (i.e. “Slow” shown in the machining page), XY step and Z step.

Parameter	Meaning	Setting range
MSpd (High)	Two types of speed under manual machining, deciding the axis motion speed during manual machining.	0.06~Max. speed of machine tool
MSpd (Slow)		0.06~Rapid jog speed
Step XYZ	The motion distance of the corresponding axis each time an axis direction key of X/Y/Z is pressed.	0.001~10000mm

Jog speed (Slow) and rapid jog speed (High) are switched by pressing . The concept of stepping (also called gridding in some other systems) is introduced for the accuracy of machining and debugging. When the system is in the stepping mode, step is the motion distance of the corresponding axis each time an axis direction key of X/Y/Z is pressed.

Under the main page, press the [OK] key to enter the parameter setting page of manual machining, as shown in Fig. 7-2.

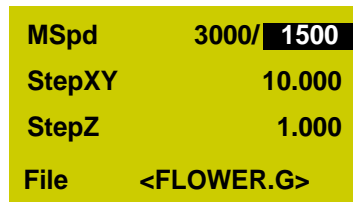

Fig. 7-2 Manual parameter setting page

Press “Up” or “Down” to select the desired parameter, and then press [OK] for confirmation after modification. Note that modification should be within the parameter range.

Current file name is displayed at the bottom of the LCD. Press “Up” or “Down” to move the cursor to the file name, and then press [OK] to enter the file list of C disk, as shown in Fig. 7-3. You can only load these files, unable to delete or copy them under this page.

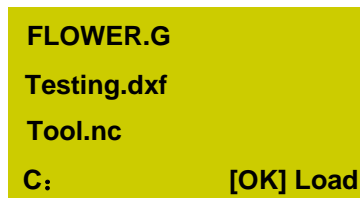

Fig. 7-3 File list page

If there is no file in the C disk, the prompt “File Not Found, Show USB File?” will be displayed; press [OK] to enter the file list of USB flash drive.

To switch between USB file list and C file list, press .

7.2. Automatic Machining

Automatic machining refers to that the system processes system files and the files in the USB flash drive in terms of instructions, also called file machining. All the parameters of machine tool and system should be set correctly before automatic machining starts.

7.2.1. Load File

◆ Load an Ordinary File

Press “Menu” to enter the menu page→ press the “Up” and “Down” keys to select “Local Files” or “USB Files”→ press [OK] to enter the corresponding file list page→ press [OK] to select the desired

machining file→ press  to load the selected file.

◆ Load an ENG File with Tool Selection Function

Find the desired ENG file following the steps above-mentioned to load an ordinary file, and then

press [OK] to select the ENG file to be machined, and then press  to automatically enter the tool selection page as shown in Fig. 7-4.

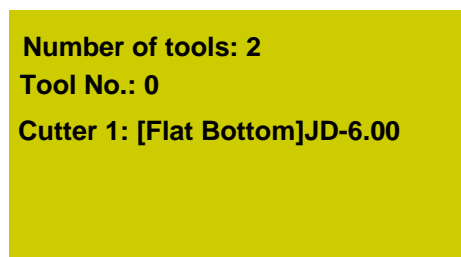

Fig. 7-4 Tool selection page



Number of tools: the number of tools in this ENG file

Tool No.: current tool No., selected by pressing the “Up” and “Down” keys

Cutter: selected by pressing the “Up” and “Down” keys, displaying tool sequence number and name

After parameters are set, press [OK] to load the file; after loading, the system will return to the machining page automatically.

7.2.2. WCS Selection

WCS and MCS are switched by pressing the combination key  + . And their screen display is as shown in Fig. 7-5.

7.2.4. Start Machining





Press the start key  to start automatic machining in the machining page.

Prompts like feedrate override and feed rate are scrolled on the LCD during file machining.

7.3. Adjustment during Automatic Machining

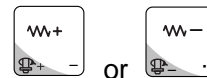

7.3.1. Feedrate Override Adjustment



Feedrate override can be increased or decreased by pressing  or  during file machining. And the feed rate changes with the feedrate override. The relation between actual feed rate and feedrate override is as follows:





$$\text{Actual feed rate} = \text{Feed rate} \times \text{Feedrate override}$$

The least unit of feedrate override is 0.1. Namely, override increases (decreases) by 0.1 after

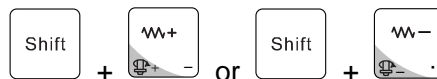
each press of  or ; at the same time, the feedrate override displayed on the LCD increases (decreases) by 10%. The range of feedrate override is within 0%~120%. In addition, the display of feed rate value changes with the feedrate override.

7.3.2. Spindle Speed Adjustment





Spindle speed are adjusted by pressing  +  or  + , and divided into 8 gears from S0~S7 with speed increasing sequentially.

7.3.3. Machining Pause and Jiggle

If machining is found not in position exactly, suspend the machining and then execute manual jiggle. Suspend machining by pressing the “Pause” key in machining, “Paus” displayed at the top right corner of the LCD while the machine tool stopping moving; as for the spindle, whether it stops or not is decided by the setting of the parameter “SOff at Pause”. Whether the spindle stops or not, at this time, the three axes can be jiggled, and the system is in “Stepping” mode by default. Each press of an axis direction key will make the corresponding axis move a specified step.

The operation steps as follows:



1) Press  in the process of machining, and then press  +  to enter the jiggle page.

2) Press “↑” or “↓” to select a step size from “0.01”, “0.02”, “0.05”, “0.10”, “0.20”, “0.50” and “1.00”.

- 3) Press one of “4”, “6”, “2”, “8”, “3” and “9” to execute jiggle on the desired axis in the corresponding direction.
- 4) Press “Start” to resume machining after jiggle.



If hard limit, soft limit or E-stop occurs in jiggle, the system will stop jiggle, give a limit prompt or an alarm, and return to the main page.

7.3.4. Soft Limit Handling

Soft limit occurs when an axis exceeds the setting range of “MachineStroke” during machining, and the system will display a limit dialog as shown below.

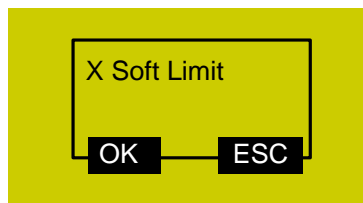

Fig. 7-7 Soft limit dialog

Press [OK] or [ESC] to exit from this warning dialog and return to the machining page, and then manually move the limit axis towards the reverse direction to release limit. After soft limit occurs, the system prohibits the limit axis from moving towards the limit direction.

7.3.5. Hard Limit Handling

The system detects hard limit periodically under the main page. When hard limit occurs, its prompt dialog is as shown in Fig. 7-8.

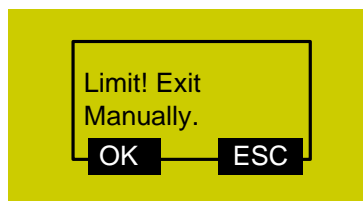

Fig. 7-8 Hard limit dialog

At this time, press [OK] to return to the main page under “Jog” mode, with “Limit Rls.” displayed at the bottom right corner of the LCD, as shown in Fig. 7-9. Or you can press [ESC] to directly back to the main page under “Jog” mode.



1X	15.617	Idle
1Y	551.107	SOff
1Z	9.900	Slow
Jog		Limit Rls.

Fig. 7-9 Prompt interface of limit release

Move the machine tool away from the limit position, "Limit Rls." disappearing. The main page returns to its normal state.

7.3.6. E-stop Handling

When E-stop occurs, the system will stop machining, and give an alarm as shown in Fig. 7-10, the "ALM" indicator on the panel ON. Before executing any other operations, remove this alarm by turning the E-stop button clockwise.

After E-stop alarm is removed, home all the axes, and then press  +  to execute breakpoint resume, i.e. to resume machining from the stop position when E-stop occurs.

1X	15.617	Estp
1Y	551.107	SOff
1Z	9.900	Slow
Jog		ESTOP2

Fig. 7-10 E-stop alarm



In E-stop state, all the other keys are invalid except the "Menu" key. You can press the "Menu" key to enter the menu page and make desired changes.









8. Cylinder ATC and Linear ATC Function













8.1. Cylinder ATC

NK105 3-axis multi-cylinder software is developed to realize alternative and synchronized machining with multi-tool.











8.1.1. Function Information of Combination Keys























◆ Functions of combination keys in G2:

Combination Key	Function
Shift +  1	Decrease of spindle speed gear
Shift +  2	First time measurement
Shift +  3	Measurement after tool change
Shift +  7	Increase of spindle speed gear
Shift +  -	Z clear
Shift +  4	Return to REF. point
Shift +  5	Return to workpiece origin
Shift +  8	Switchover between WCS and MCS
Shift +  0	Moveable measurement

Combination Key	Function
 + 	Show help info page of combination key
 + 	Open tool measuring page
 + 	Cylinder 1 ON/OFF
 + 	Cylinder 2 ON/OFF
 + 	Cylinder 3 ON/OFF (exclusive for 3-cylinder 1-inverter software)
 + 	Show simulation machining range

◆ Functions of combination keys in G3:

Combination Key	Function
 + 	Return to the fixed point
 + 	Cylinder 1 ON/OFF
 + 	Cylinder 2 ON/OFF
 + 	Cylinder 3 ON/OFF (exclusive for 3-cylinder 1-inverter software)
 + 	Open tool measuring page

Combination Key	Function
 + 	Y clear
 + 	Decrease of spindle speed gear
 + 	X clear
 + 	Increase of spindle speed gear
 + 	Return to REF. point
 + 	Switchover between WCS and MCS
 + 	Moveable measurement
 + 	Show help info page of combination key
 + 	Jiggle at pause
 + 	Breakpoint resume
 + 	Show simulation machining range



1) The combination key in the above two tables are ones by default.

2) Pressing combination key “Shift+Menu key” can open the help page of combination key list.









8.1.2. Tool Change Parameters







You can find “Tool Change” under “Oper Param”.

Parameter	Function	Setting Range
ATC Capacity	Capacity of tool magazine	1~20
CurrentToolNo.	Tool No. of the currently loaded tool	1~ATC Capacity
Tool Offset	Tool offset in each axis direction	X/Y/Z: -10000~10000 (mm)
ToolChangeTip	Whether to give a prompt when there is tool change command in the file	Yes: Prompt No: Not prompt
Cali Coor	Machine coordinates of tool sensor (presetter)	/
Cut Up Pos	Machine coordinates of upper position in tool change	/
Change tool sp	Tool moving speed in tool change	0.001~Max. speed of the machine tool
Pre-TC pos	Machine coordinates of pre-position in tool change	/
Tool positio	Machine coordinates of currently loaded tool	/
Calibrate Too	Whether to automatically measure the tool after tool change	Yes: Measure No: Not measure
Back Pre_Pos	Whether to back to the previous position before tool change after tool change completed	Yes: Back No: Not back
Change Delay	Delay time for tool change	0~600000 (ms)

8.1.3. Cylinder Operation Method

◆ 3-cylinder 1-inverter software

For NK105G3 CNC system: pressing  +  in the jog mode will make Z axis lift up to the “Cut Up Pos”, and start cylinder 1; pressing  +  again will close cylinder 1. Cylinder 2 and cylinder 3 can be started and closed by pressing  +  and  + . Remember that only one cylinder can be opened at one time. If a cylinder is opened, it will be turned off automatically if another cylinder is turned on.

To turn on/off cylinder 1/2/3 in NK105G2 CNC system, the corresponding shortcut keys are  +  ,  +  and  + .

◆ 2-cylidner 2-inverter software

For NK105G3 CNC system, pressing + in the jog mode will make Z axis lift up to the “Cut Up Pos”, and start cylinder 1; pressing + again will close cylinder 1. Cylinder 2 can be started and closed by pressing + . Remember that only one cylinder can be opened at one time. If one cylinder is opened, it will be turned off automatically if the other cylinder is turned on.

To turn on/off cylinder 1/2 in NK105G2 CNC system, the corresponding shortcut keys are + and + .



The operations introduced above, taking NK105G2/NK105G3 multi-cylinder software as an example, are provided for reference only.

8.1.4. Process of Tool Change

◆ 3-cylinder 1-inverter software

After machining starts, in case of meeting T1 command, the system will open spindle 1 while opening cylinder 1; in case of meeting T2 command, the system will close cylinder 1 and spindle 1, move Z axis to “Cut Up Pos”, open cylinder 2 and spindle 2, and call the position offset of tool 2 for machining; in case of meeting T3 command, the system will close cylinder 2 and spindle 2, move Z axis to “Cut Up Pos”, open cylinder 3 and spindle 3, and call the position offset of tool 3 for machining; after machining finishes, the system will close the current cylinder and spindle.



◆ 2-cylidner 2-inverter software

After machining starts, in case of meeting T1 command, the system will open spindle 1 while opening cylinder 1; in case of meeting T2 command, the system will close cylinder 1 and spindle 1, move Z axis to “Cut Up Pos”, open cylinder 2 and spindle 2, and call the position offset of tool 2 for machining; after machining finishes, the system will close the current cylinder and spindle.

8.1.5. Tool Measurement Page

Pressing + will open a tool measuring page, where three types of tool measurement are supported, namely “Manual Set” “Single Measure” and “All Measure”.

◆ Manual Set

Manually move the tool onto a certain height, press  +  to open the tool measurement page. Selecting the menu item “Manual Set” can set the current Z machine coordinate to the current tool offset of Z axis.

◆ Single Measure

Single tool measurement. Manually move the spindle/tool onto a position above the fixed tool sensor (also called tool presetter), and select “Single Measure” in the measuring page. The system will conduct measuring process automatically and set the measuring result to the current tool offset of Z axis.

◆ All Measure

Namely, measuring tools one by one. Like single measuring, manually move the spindle/tool onto a position above the fixed tool sensor and select “All Measure” item. The system will conduct measuring process automatically and set the result to the current tool offset of Z axis. Please note that measuring process of “All Measure” differs because of different cylinder configuration.

➤ For Dual-cylinder Configuration

If the current tool (the tool in the spindle) is T1, the measuring sequence is T1-T2; if the current tool is T2, the measuring sequence will be T2-T1.

➤ For Three-cylinder Configuration

If the current tool is T1, the measuring sequence is T1-T2-T3; if the current tool is T2, the measuring sequence is T2-T3-T1; if the current tool is T3, the measuring sequence is T3-T2-T1.



“Manual Set” “Single Measure” and “All Measure” are effective on condition that the current tool is single tool, or tool number being 1 or 2 or 3.

8.1.6. Breakpoint Resume

After breakpoint resume or power-off resume is executed, the system will open the corresponding cylinder according to the tool No. before machining stops, and start the spindle after 200ms delay.



The purpose of 200ms delay is to guard against the cylinder not in-position and the spindle and the inverter not connected.

8.1.7. Simulation

To execute simulation function, you can press + (or +). You can also find “4. Machining Info” under “3. Operations”, and then press “OK”. After simulation, the system will display estimated machining time and machining range of each axis.









8.2. Linear ATC

Linear tool magazine refers to a tool magazine storing tools in array. For example, if a customer has 12 tools, he can select a 1-line 12-row tool magazine, or a 2-line 6-row tool magazine, etc. Auto tool change can be realized by programming in the public.dat according to the above related information learned from the customer. NK105 linear tool magazine software is developed to realize machining with multi-tool.



8.2.1. Function Information of Combination Keys













◆ Functions of combination keys in G2:



Combination Key	Function
+	Moveable tool measurement
+	Decrease of spindle speed gear
+	First time measurement
+	Measurement after tool change
+	Return to REF. point

Combination Key	Function
Shift + 	Return to workpiece origin
Shift + 	Auto measure of tool length
Shift + 	Increase of spindle speed gear
Shift + 	Switchover between WCS and MCS
Shift + 	Clamp/unclamp tool manually
Shift + 	Z clear
Shift + 	Jiggle at pause
Shift + 	Show help info page of combination key
	Breakpoint resume

◆ Functions of combination keys in G3:

Combination Key	Function
Shift + 	Return to fixed point
Shift + 	Clamp/unclamp tool manually

Combination Key	Function
Shift + 	First time measurement
Shift + 	Measurement after tool change
Shift + 	Auto measure of tool length
Shift + 	Return to REF. point
Shift + 	Switchover between WCS and MCS
Shift + 	Moveable tool measurement
Shift + 	X clear
Shift + 	Y clear
Shift + 	Increase of spindle speed gear
Shift + 	Decrease of spindle speed gear
Shift + 	Jiggle at pause
Shift + 	Show help info page of combination key

Combination Key	Function
 + 	Breakpoint resume









- 1) Please note that the combination key in the above two tables are ones by default.
- 2) Pressing combination key “Shift+Menu key” can open help information page of combination key.

8.2.2. Tool Change Parameters

You can find “Tool Change” under “Oper Param”. See 0 for reference.

8.2.3. Clamp/Unclamp Tool Manually



For NK105G3 CNC system, you can press  +  to execute the tool unclamp command when manually changing a tool as needed in some special situations. At this time, the LED beside the terminal GY18 on the control box becomes light. After manually changing the tool, you need to press  +  to execute the tool clamp command, the LED beside the terminal GY18 on the control box turning off.

For NK105G2 CNC system,  +  is the combination key to manually clamp/unclamp tool.

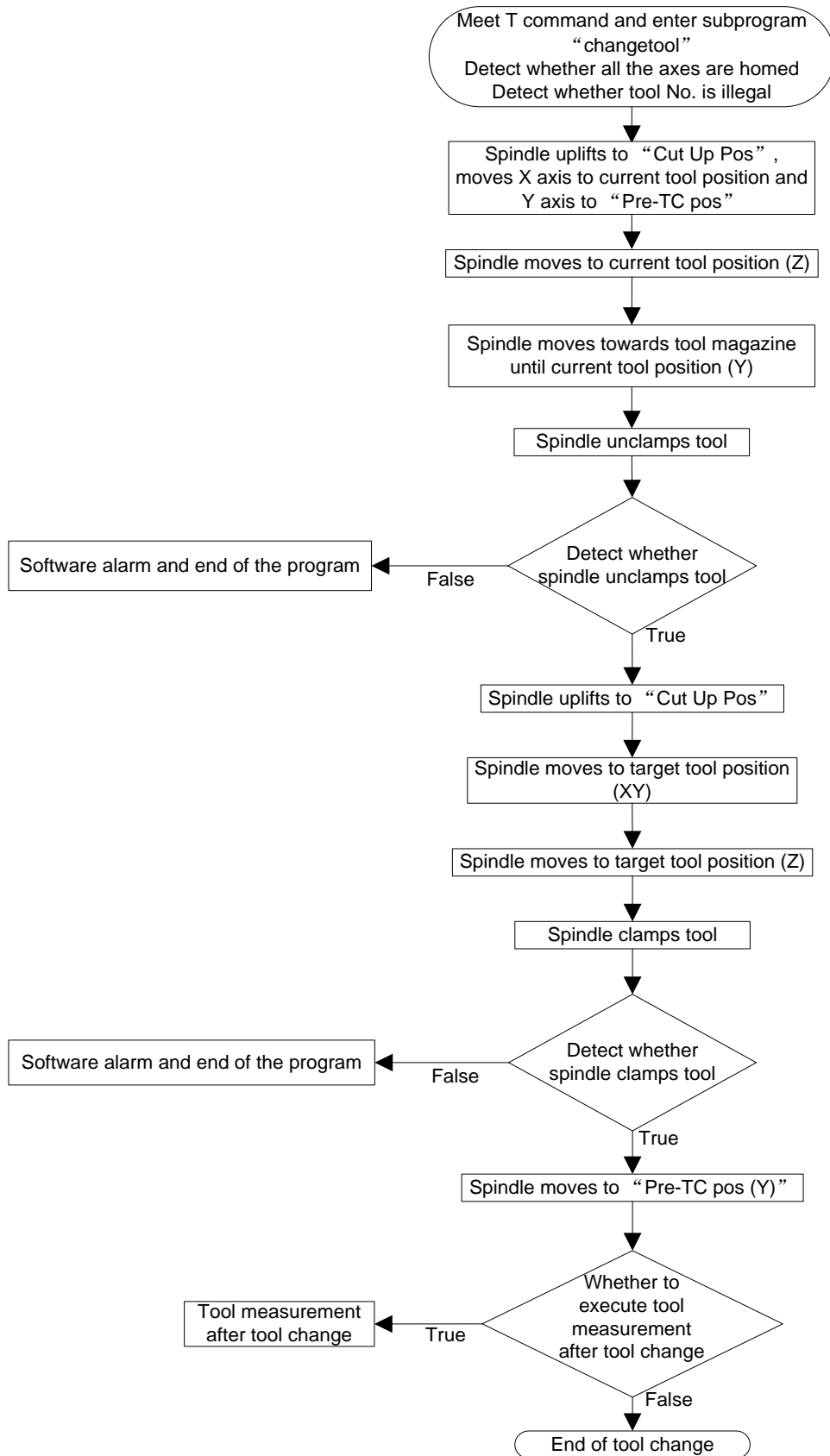
8.2.4. Process of Linear Tool Change



8.2.5. Auto Measure of Tool Length

For NK105G2/G3 CNC system, pressing  +  will automatically measure tool length. After tool length measured, the system will give a prompt “Succeed to set the tool length!”

8.2.6. Process of Tool Measurement

NK105 has three kinds of tool measurement. They are first time measurement, measurement after tool change and moveable tool measurement. The last one is the mostly used tool measurement in linear tool magazine software.

Moveable tool measurement executes tool measurement at the current position and probes workpiece surface, used for setting Z-axis workpiece origin.

The sketch map of the process of moveable tool measurement is as shown in Fig. 8-1:

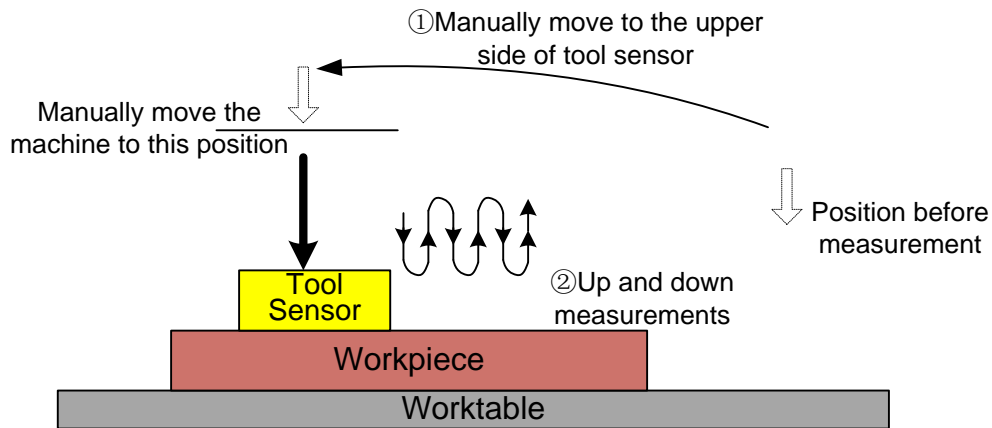

Fig. 8-1 Sketch map of moveable tool measurement

9. System Update

NK105G2/G3 can be used directly since the software has already been well installed before delivered. In case of breakdown, update the system.

9.1. Software Update

Software update is included in the process of system image update. If there is no need updating the system image, directly update the software following the below steps:

- 1) Store the software application to be updated under the root directory of an USB flash drive, and then insert the USB flash drive into the USB interface of NK105 control box. (The software application is composed of five file folders—“*CHN*”, “*Config*”, “*ENG*”, “*Font*”, and “*NewNK200*”, which should all be under the root directory of the USB flash drive)
- 2) Power on NK105, press “Shift” to enter the menu page, select “7. System Upkeep” and “3. System Update” in turn, and operate according to the tips on the LCD until “USB Available Now!” appears. Press “OK” to enter the system update interface, and then select “Delete parameter”. After parameter files are deleted, select “Update system” to start updating the software. After update completed, the new software will be rebooted automatically.



Parameters should be restored to factory setting after each software update, unless the update software is totally the same as the old software (e.g. the same version). If “Delete parameter” is not selected in the process of update, it is a must to restore ex-factory parameters after software updated by following the below steps: after the system is rebooted, press “Shift” to enter the menu page; and then select “6. Param Upkeep” and “3. Factory Params” sequentially, and then operate according to the tips on the LCD.

9.2. System Mirror Update

- 1) Store the system image (*NK105_NK_RX.X.X.nb*, please make sure the version of the image file is the latest one) and the software application to be updated under the root directory of an USB flash drive (above 1G), and then insert the USB flash drive into the USB interface of the NK105 control box. (The software application is composed of five file folders—“*CHN*”, “*Config*”, “*ENG*”, “*Font*”, and “*NewNK200*”, which should all be under the root directory of the USB flash drive)
- 2) Power on NK105, and then long press the “Menu” key  until entering the update selection interface. Press “1” to select “1: Update menu”, and then press 3 to select “3: OS” in the new pop-up page to start updating the system image.
- 3) Note that this process is a little long, about 3 minutes. After completed, “USB Available Now!” will be displayed on the LCD. Press “OK” to enter the system update interface, and then select

“Update system” to start updating the software. After update completed, the new system will be rebooted automatically.

The steps of EBOOT and FPGA update are similar to those of image update. The file for FPGA update is *NK105_FPGA_RXX.XX.XX.dat*, while that for EBOOT update is *NK105_EBOOT_RXX.XX.XX.nb0*. They should also be placed under the root directory of an USB flash drive. After entering the update selection interface and pressing “1” (“1: Update menu”), you can start FPGA update by pressing “1” (“1: FPGA”), or EBOOT update by pressing “2” (“2: BOOT”).



Since image update clears all the old files, it is strongly recommended to do backup before image update.

10. Driver

10.1.Driver Parameters

Driver parameters listed in this chapter can only make a machine tool motion normally, without ensuring machining effects. To get a better machining result, you need to read through the servo driver documentation of the corresponding brand and change the parameter setting according to the specific machine tool.

10.1.1. Parameter Setting of WISE Servo Driver

Para. No.	Function	Value	Description
Pr528	LED initial status	6	Monitor if the number of sent and received pulses is correct by setting this parameter. In Weihong control system, the correct quantity of pulse sent by control card is detected by pulse inspection in order to determine whether there is electrical interference.
Pr008	Command pulse No. per motor circle	0	When it is set to "0", parameters Pr009 and Pr010 are valid.
Pr009	1 st numerator of command pulse frequency division/multiplication	Need calculation	Range: $0 \sim 2^{30}$ Typical value: pitch 5 mm, encoder resolution 10000, deceleration ratio 1:1, pulse equivalent 0.001 mm: Pr009=10000 Pr010=pitch 5mm/ pulse equivalent 0.001mm=5000 Pr009/Pr010=10000/5000=2/1
Pr010	Denominator of command pulse frequency division/multiplication	Need calculation	
Pr100	1st position loop gain	480 (default)	Unit: 0.1/s. Set it according to the actual situation.
Pr101	1st velocity loop gain	270 (default)	Unit: 0.1Hz. Set it according to the actual situation.
Pr102	1st velocity loop integrated time constant	210 (default)	Unit: 0.1ms. Set it according to the actual situation.

Attached List: the relationship among parameters Pr008, Pr009 and Pr010.

Pr008	Pr009	Pr010	Description
$0 \sim 2^{20}$	— (no influence)	— (no influence)	<p>As shown above, the process is undergone in terms of the setting value of Pr008, not affected by the settings of Pr009 and Pr010.</p>
0	0	$0 \sim 2^{30}$	<p>When the values of Pr008 and Pr009 are both set to "0", as</p>

Pr008	Pr009	Pr010	Description
			shown above, the process is undergone in terms of the setting value of Pr010.
	0~2 ³⁰	0~2 ³⁰	<div style="display: flex; align-items: center; justify-content: space-around;"> <div style="text-align: center;"> <p>Command Pulse Input</p> <p>→</p> </div> <div style="border: 1px solid black; padding: 5px; text-align: center;"> <p>[Setting Value of Pr009]</p> <p>[Setting Value of Pr010]</p> </div> <div style="text-align: center;"> <p>→</p> <p>Position Command</p> </div> </div> <p>When the value of Pr008 is “0”, but the value of Pr009 is not “0”, as shown above, the process is undergone in terms of the setting values of Pr009 and Pr010.</p>

10.1.2. Parameter Setting of YASKAWA Σ -II Servo Driver

Para. No.	Function	Value	Description
Fn010	Set password (to prevent arbitrarily modification to parameters)	0000	Set [0000]: modification to user parameters [PnXXX] and part of auxiliary function parameters [FnXXX] permitted; Set [0001]: modification to user parameters [PnXXX] and part of auxiliary function parameters [FnXXX] prohibited.
Un00C	Pulse counter of input command	LXXXX (Hexadecimal system)	Monitor if the number of sent and received pulse is correct by setting this parameter. In Weihong control system, the correct quantity of pulse sent by control card is detected by pulse inspection in order to determine whether there is electrical interference.
Pn000	Direction selection Control mode selection	0010	Bit 0: Set 0, "CCW" is forward rotation (viewed from the load end of screw ball); Set 1, the rotation direction of the motor is reversed. Bit 1: Set 1, position control mode (calculate pulse instruction all the time).
Pn200	Select pulse instruction mode	0005	Bit 0: Set 5, select the instruction input mode as "pulse + direction", negative logic. Bit 3: Set 0, input differential signal into filter.
Pn50A	Selection function	8100	Bit 1: Set 0, Servo ON /S-ON, input from 40th pin; Set 7, Servo ON all the time. Bit 3: Set 8, positive rotation not used and signal input (P-OT) prohibited.
Pn50B	Selection function	6548	Bit 0: Set 8, reverse rotation not used and signal input (N-OT) prohibited.
Pn50F	Selection function	0300	Set it when servo motor with brakes. Bit 2: Set 3, brake interlock signal "/BK" is output from CN1-29, CN1-30 to control 24V relay for brake
Pn50E	Selection function	0211	Set it when servo motor with brakes To avoid of CN1-29 and CN1-30 being used for other function and leading to brake ineffective, "3" is not allowed to appear in the 4 digits.
Pn506	Servo off, time delay of brake when motor stops	Depended	Set it when motor with brakes Default setting is "0", setting unit is 10ms.

Para. No.	Function	Value	Description		
Pn201	Encoder cycle-divided ratio(Pulse output No. per motor cycle by encoder after cycle-divided)	Right-side	Gain Encoder	Type	Encoder Pulse No. per Motor Circle (pulses/ revolution)
				A	13bit 2048
				B	16bit 16384
				C	17bit 32768
Pn202	Electronic gear ratio (numerator)	Need Calculation	Pn202 = pulse No. of each encoder circle × 4 × mechanical deceleration ratio. Pn203 = (screw pitch/ pulse equivalent). Typical value: pitch 5mm, encoder 17-bit, deceleration ratio 1:1, pulse equivalent 0.001mm, Pn202=16384; Pn203=625. Pitch 5mm, encoder 17-bit, deceleration ratio 1:1, pulse equivalent 0.0005mm, Pn202=8192; Pn203=625.		
Pn203	Electronic gear ratio (denominator)	Need Calculation			

10.1.3. Parameter Setting of DELTA ASDA-A Servo Driver

Para. No.	Function	Format & Range	Value	Description
P0-02	Driver status display		02	Monitor if the number of sent and received pulse is correct by setting this parameter. In Weihong control system, the correct quantity of pulse sent by control card is detected by pulse inspection in order to determine whether there is electrical interference.
P1-00	External pulse input type	ZYX	002	X=2: pulse + direction; Z=0: positive logic
P1-01	Control mode setup	ZYX1X0	0000	Z=0: during control mode switching, DIO is maintaining the set value, regardless of mode switching, so Z=0. Y=0: forward rotation (CCW) (in terms of load), Y=1, the rotation direction is reversed; X1X0=00: position control mode
P1-32	Motor stop mode selection	YX	00	Y=0: when there is no servo enabled, motor dynamic brake occurs; Y=1: motor is free. X=0: motor stops instantly, X=1: motor stops with deceleration.
P1-44	Electronic Gear Ratio (Numerator) (N1)	1~32767	Need calculation	N1/M= encoder pulses× 4× pulse equivalent× mechanical deceleration ratio / pitch. Representative value: encoder pulses=2500, pitch=5mm, pulse equivalent=0.001, deceleration ratio=1, calculation as below: N1/M= 2500×4×0.001/5 = 2 / 1, N1=2, M=1;
P1-45	Electronic Gear Ratio (Denominator) (M)	1~32767	Need calculation	When the multi-electronic gear ratio is not used, P2-60~ P2-62 are not required.
P2-10	Digital Input Pin DI1	X2X1X0	101	X1X0=01: digital input (DI1=SON) corresponds to 9th pin of CN1. X2 = 1: set DI1 input as NO (normally open) a-contact point.
P2-15	Digital Input pin DI6	X2X1X0	100	Default factory setting of DI6 and DI7 are NC (normally closed) limit signal input pins; driver can't run without being connected to pin 32 and pin 31 of CN1.
P2-16	Digital Input Pin DI7	X2X1X0	100	X2=1: set DI6 and DI7 inputs as NO (normally open) a-contact points; X1X0=00, limit signal input of the driver is not used.

Para. No.	Function	Format & Range	Value	Description
P2-17	Function setting for digital input pin DI8	X2X1X0	100	External EMG stop input is not used.
P2-21	Function setting for digital output pin DO4	X2X1X0	108	DO4 corresponds to pin 1 & pin 26, used as clamping-position brake signal of Z-axis; X2=1: set DO4 output as NO (normally open) a-contact point; X2=0: set DO4 output as NC (normally closed) b-contact point; X1X0=08: set pin 1 and pin 26 as BK+ and BK- respectively.
P2-22	Function setting for digital output pin DO5	X2X1X0	007	DO5 corresponds to pin 28 & pin 27, used as servo alarm signal. X2=0: set DO5 output as NC b-contact point. X1X0=07: set pin 28 and pin 27 as ALRM+ and ALRM- respectively.
P2-51	Servo ON (SON) setup		0	0: Servo ON must be triggered by numerical input signal. 1: when servo is powered, if there is no alarm signal, servo will be on automatically. Set 1 when there is no SON signal line.

10.1.4. Parameter Setting of DELTA ASDA-A2 Servo Driver

Para. No.	Function	Format & Range	Value	Description
P0-02	Driver status display		02	Monitor if the number of sent and received pulse is correct by setting this parameter. In Weihong control system, the correct quantity of pulse sent by control card is detected by pulse inspection in order to determine whether there is electrical interference.
P1-00	External pulse train input type	ZYX	002	X=2: pulse + direction; Z=0: positive logic
P1-01	Set control mode	ZYX1X0	0000	Z=0: during control mode switching, DIO is maintaining the set value. Since switching control mode is not used, Z=0; Y=0: forward rotation (CCW) (from the view of load); Y=1: the rotation direction is reversed. X1X0=00: position control mode
P1-44	Electronic Gear Ratio (Numerator)(N1)	1~32767	Need calculation	N1/M= mechanical deceleration ratio × 4 × encoder pulses× pulse equivalent / pitch. Representative value: encoder pulses=2500, pitch =5mm, pulse equivalent=0.001, deceleration ratio = 1, calculation as below:
P1-45	Electronic Gear Ratio (Denominator)(M)	1~32767	Need calculation	N1 / M = 2500×4×0.001/5 = 2/1, N1=2, M=1; When the multi-electronic gear ratio is not used, P2-60 ~P2-62 are not required.
P2-10	Digital Input Pin 1 (DI1)	X2X1X0	101	X1X0=01: digital input (DI1 = SON) corresponds to 9 th pin of CN1. X2=1: set DI1 input as NO (normally open) a-contact point.
P2-15	Function setting for digital input pin DI6	X2X1X0	100	Default factory setting of DI6 and DI7 is NC (normally closed) limit signal input; driver can't run without being connected to pin 32 and pin 31 of CN1. X2=1: set DI6 and DI7 input as NO a-contact points. X1X0=00, limit input of driver is not used.
P2-16	Function setting for digital input pin DI7	X2X1X0	100	

Para. No.	Function	Format & Range	Value	Description
P2-17	Function setting for digital input pin DI8	X2X1X0	100	External EMG stop input is not used.
P2-21	Function setting for digital output pin DO4	X2X1X0	108	DO4 corresponds to pin 1 & pin 26, used as clamping-position brake signal of Z-axis; X2=1: set DO4 output as NO (normally open) a-contact point; X2=0: set DO4 output as NC (normally closed) b-contact point; X1X0=08: set pin 1 and pin 26 as BK+ and BK- respectively.
P2-22	Function setting for digital output pin DO5	X2X1X0	007	DO5 corresponds to pin 28 & pin 27, used as servo alarm signal. X2=0: set DO5 output as NC b-contact point. X1X0=07: set pin 28 and pin 27 as ALRM+ and ALRM- respectively.

10.1.5. Parameter Setting of PANASONIC MINAS_A4 Servo Driver

Para. No.	Function	Value	Description
Pr01	LED initial status	12	Monitor if the number of sent and received pulse is correct by setting this parameter. In Weihong control system, the correct quantity of pulse sent by control card is detected by pulse inspection in order to determine whether there is electrical interference.
Pr02	Select control mode	0	0: position mode 1: velocity mode 2: torque mode
Pr40	Select command pulse input	1	1: input through difference exclusive circuit
Pr42	Select command pulse input mode	3	Set command pulse input mode: command pulse + command direction, negative logic
Pr48	The 1st numerator of the command pulse frequency multiplication	Need calculation Range: 1~10000	Typical values: pitch 5 mm, encoder resolution 10000, deceleration ratio 1:1, pulse equivalent 0.001 mm: Pr48=10000 Pr4B= pitch 5mm/ pulse equivalent 0.001mm=5000 So, Pr48/Pr4B=10000/5000=2/1
Pr4B	Denominator of the command pulse frequency multiplication	Need calculation Range: 1~10000	

After the parameters are set, writing mode of EEPROM has to be selected. Please refer to the following steps:

- 1) Press [MODE] button → Select [EEPROM]→ Enter mode [EE_SET];
- 2) Press SET button, showing [EEP —];
- 3) Keep pressing UP direction key for approx. 3 seconds, then [EEP ——] will be displayed, and then writing starts until [Start] is displayed.

If [Finish] is displayed after saving the parameters, it means successful modification. If [Reset] is shown, alteration will be validated only after restarting the driver. If [Error] occurs, the write-in is a failure, and another setting is needed.

10.1.6. Parameter Setting of FUJI FALDIC-β Servo Driver

Para. No.	Name	Value	Description
01	Command pulse numerator α	Need calculation 1~32767	Command pulse numerator and denominator are also equal to those of the electronic gear ratio. $\alpha / \beta = \text{encoder resolution} \times \text{pulse equivalent} \times \text{mechanical deceleration ratio} / \text{screw pitch}$.
02	Command pulse denominator β	Need calculation 1~32767	Typical value: encoder resolution 65536, pitch 5mm, pulse equivalent 0.001, mechanical deceleration ratio 1, $\alpha / \beta = 65536 \times 0.001 / 5 = 8192 / 625$, So $\alpha = 8192$, $\beta = 625$.
03	Pulse string input form	0	Set the input mode of pulse string as: instruction + symbol, that is 'pulse + direction'.
04	Direction of rotation switch	0 or 1	Set 0: Positive direction: Forward rotation (CCW); Set 1: Positive direction: Reverse rotation (CW).
10	CONT1 distribution signal	1	CONT1 is distributed as RUN (i.e. SON); if not distributed, CONT1 will be auto ON if there is no alarming when powered.
11	CONT2 distribution signal	2	CONT2 is distributed as RST (i.e. servo alarming clearance CLR). When 12, 13, 14 are 0, that is CONT3, CONT4 and CONT5 can't be distributed as OT (over-travel) or EMG (external emergency stop).
15	OUT1 distribution signal	1	Set 1, OUT1 is distributed as a-contact point of alarming output; Set 2, OUT1 is distributed as b-contact point of alarming detection.
27	Parameter write-protection	0 or 1	Set 0, write-enable. Set 1, write-protected.
74	CONT Always ON 1	1	Its initial value is 0, and it is set "1" here to enable servo (RUN).



FUJI servo has no braking signal wire, so there is no need to set the parameters related to braking; you only need to provide 24V brake power to pin Br (lead wire 5 and 6) of motor with braking.

10.1.7. Parameter Setting of STONE GS Servo Driver

Para. No.	Para. Name	Value	Description																							
F0f	Electronic gear ratio numerator	2	Electronic gear ratio of position mode: $4 \times \text{pulse frequency fed back by motor encoder} = \text{command pulse frequency} \times F0f / F10$; value of $F0f / F10$ must be within 1/100~100. (calculated with pitch as 10mm)																							
F10	Electronic gear ratio denominator	1																								
F00	Control mode selection	2	<p>0: external speed running mode; make sure the value and direction of motor speed according to the external analog -10V ~ +10V signal of CN2-16, 17;</p> <p>1: internal speed running mode; make sure the value and direction of motor speed according to the setting of parameter F33, F35, F37, F39 and the port status of CN2-9, CN2-25;</p> <p>2: position pulse running mode; receive the input of external position command pulse and direction level signal;</p> <p>3: jog mode; make sure the motor speed in terms of parameter setting of F3b, and control the rotation direction by the direction keystroke ▼ and ▲;</p> <p>4: torque mode; make sure the value and direction of motor torque according to the external analog -10V ~ +10V signal of CN2-43, 1;</p> <p>5~10: mixed mode; select mode according to the port input status of CN2-24:</p> <table border="1" style="margin-left: 20px;"> <thead> <tr> <th rowspan="2">F00 Value</th> <th colspan="2">CN2-24 Interface Status</th> </tr> <tr> <th>OFF (Mode One)</th> <th>ON (Mode Two)</th> </tr> </thead> <tbody> <tr> <td>5</td> <td>Position Pulse Mode</td> <td>External Speed Running Mode</td> </tr> <tr> <td>6</td> <td>Position Pulse Mode</td> <td>Internal Speed Running Mode</td> </tr> <tr> <td>7</td> <td>Position Pulse Mode</td> <td>Torque Mode</td> </tr> <tr> <td>8</td> <td>Internal Speed Running Mode</td> <td>External Speed Running Mode</td> </tr> <tr> <td>9</td> <td>Internal Speed Running Mode</td> <td>Torque Mode</td> </tr> <tr> <td>10</td> <td>External Speed Running Mode</td> <td>Torque Mode</td> </tr> </tbody> </table>	F00 Value	CN2-24 Interface Status		OFF (Mode One)	ON (Mode Two)	5	Position Pulse Mode	External Speed Running Mode	6	Position Pulse Mode	Internal Speed Running Mode	7	Position Pulse Mode	Torque Mode	8	Internal Speed Running Mode	External Speed Running Mode	9	Internal Speed Running Mode	Torque Mode	10	External Speed Running Mode	Torque Mode
F00 Value	CN2-24 Interface Status																									
	OFF (Mode One)	ON (Mode Two)																								
5	Position Pulse Mode	External Speed Running Mode																								
6	Position Pulse Mode	Internal Speed Running Mode																								
7	Position Pulse Mode	Torque Mode																								
8	Internal Speed Running Mode	External Speed Running Mode																								
9	Internal Speed Running Mode	Torque Mode																								
10	External Speed Running Mode	Torque Mode																								
F2e	Pulse input mode selection	2	Command pulse string mode selection of position mode:																							

Para. No.	Para. Name	Value	Description		
			1- single pulse string positive logic		
			pulse	12 27	
			direction	13 28	
			2 - single pulse string negative logic		
			pulse	12 27	
			direction	13 28	
			3 - double pulse strings positive logic		
			CCW	12 27	
			CW	13 28	
			4 - double pulse strings negative logic		
			CCW	12 27	
			CW	13 28	
5 - quadrature pulse positive logic					
phase A	12 27				
phase B	13 28				
6 - quadrature pulse negative logic					
phase A	12 27				
phase B	13 28				

10.1.8. Parameter Setting of MITSUBISHI MR-E Servo Driver

Para. No.	Code	Function	Value	Description
0	*STY	Select control mode and regenerative fittings	X0X0	Bit 0: set 0: select position control mode. Bit 1, select motor series: 0: HC-KFE; 1: HC-SFE; Bit 3, select regenerative apparatus, set 0: not use. Bit 4, select motor power.
1	MBR	Function selection 1	001X	Bit 0: input signal filter. If external input signal causes chattering due to noises, etc., input filter is used to suppress it. Bit 1: CN1-12 function selection, set "1": electromagnetic brake interlock (MBR); set "0": zero speed detection signal.
3	CMX	Electronic gear numerator	Need calculation	$CMX/CDV = \text{command unit} \times \text{servo motor resolution} \times \text{mechanical deceleration ratio} / \text{pitch of screw}$. E.G., pitch 5 mm, encoder resolution 10000, deceleration ratio 1:1, pulse equivalent 0.001 mm, $CMX/CDV = 10000 \times 0.001 / 5 = 2/1$; When pulse equivalent = 0.0005mm, $CMX/CDV = 1/1$. Electronic gear ratio range: 1/50 ~ 500
4	CDV	Electronic gear denominator	Need calculation	

Para. No.	Code	Function	Value	Description
18	*DMD	Status display selection	00XX	3: cumulative command pulses E: load inertia When the parameter is set [3], monitor if the number of sent and received pulse is correct by setting this parameter. In Weihong control system, the correct quantity of pulse sent by control card is detected by pulse inspection to determine if there is electrical interference.
21	*OP3	Function selection 3 (command pulse format selection)	0001	Set pulse command input form: pulse train+ sign, negative logic
41	*DIA	Signal input SON-ON, LSP-ON and LSN-ON automatically selection	0110	Bit 0: Servo-ON selection. [0]: servo on by external input; [1]: servo on all the time inside. Bit 1: last signal of positive rotation range (LSP): [1]: auto servo on inside, without external wiring. Bit 3: last signal of negative rotation range (LSN) : [1]: auto servo on inside and no need of external wiring.



Regarding parameters with the symbol “*” in front, when changed, they will be effective after re-power on the driver.

10.2. Wiring Diagram of NK105 and Driver

10.2.1. Wiring Diagram of NK105 and Differential Input Stepping Driver

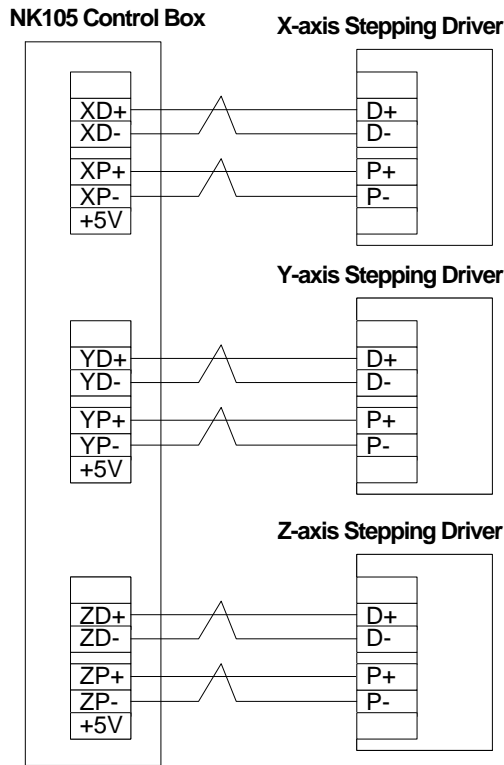

Note: twisted pair adopted for differential signal

Fig. 10-1 Wiring of NK105 control box and differential input stepping driver

10.2.2. Wiring Diagram of WISE Servo Driver

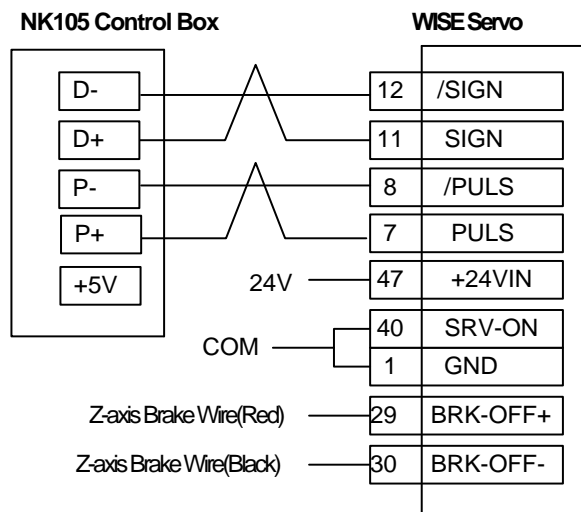

Note: twisted pair adopted for differential signal

Fig. 10-2 Wiring diagram of NK105 and Wise servo driver

10.2.3. Wiring Diagram of YASKAWA Σ -II Servo Driver

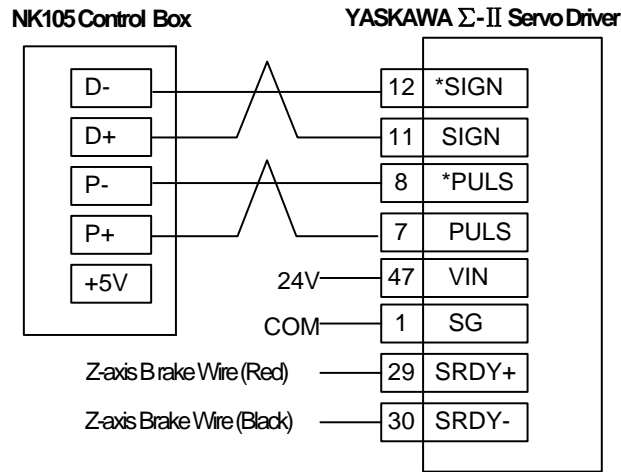

Fig. 10-3 Wiring diagram of NK105 and YASKAWA Σ -II servo driver



Wirings of X axis, Y axis, and Z axis are the same. Only Z axis has two brake signal lines which can be connected to relay to control brake.

10.2.4. Wiring Diagram of DELTA ASDA Servo Driver

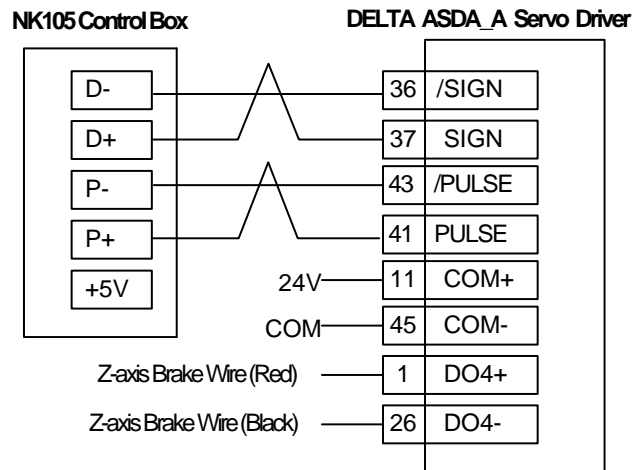

Fig. 10-4 Wiring diagram of NK105 and DELTA ASDA_A servo driver

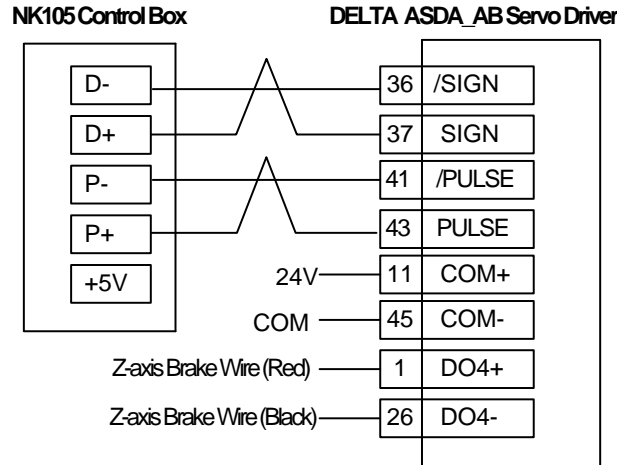

Fig. 10-5 Wiring diagram of NK105 and DELTA ASDA_AB servo driver



Wirings of X axis, Y axis, and Z axis are the same. Only Z axis has two brake signal lines which can be connected to relay to control brake.

10.2.5. Wiring Diagram of PANASONIC MINAS_A4 Servo Driver

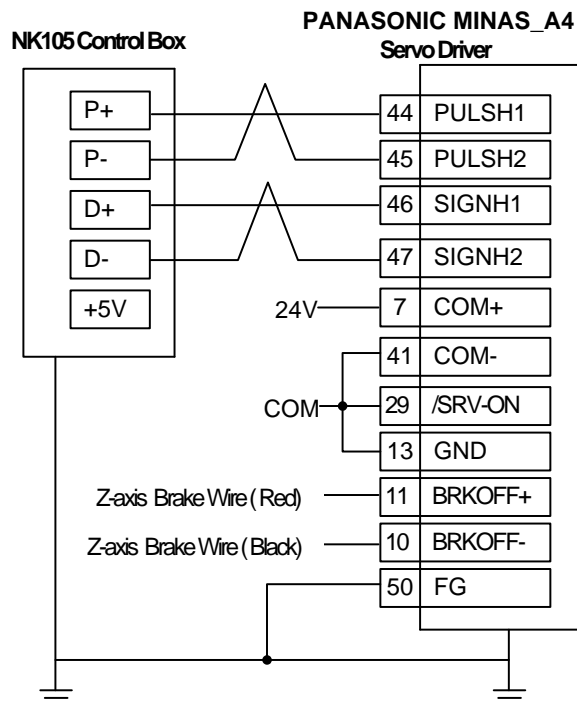

Fig. 10-6 Wiring diagram of NK105 and PANASONIC MINAS_A4 servo driver



Wirings of X axis, Y axis, and Z axis are the same. Only Z axis has two brake signal lines which can be

connected to relay to control brake.

10.2.6. Wiring Diagram of MITSUBISHI MR-E Servo Driver

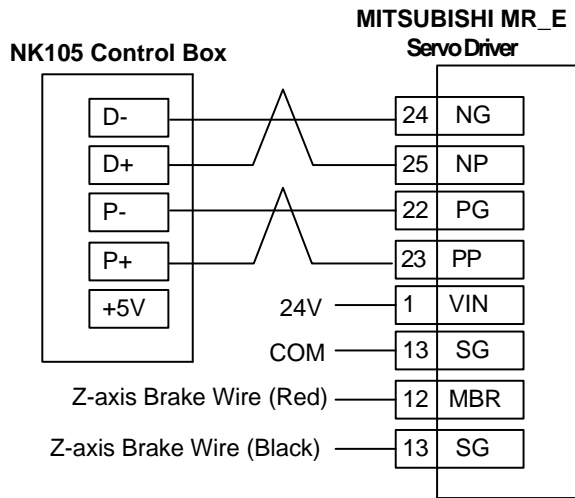
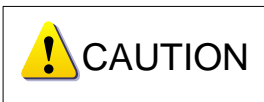

Fig. 10-7 Wiring diagram of NK105 and MITSUBISHI MR-E servo driver



Wirings of X axis, Y axis, and Z axis are the same. Only Z axis has two brake signal lines which can be connected to relay to control brake.

10.2.7. Wiring Diagram of FUJI FALDIC-β Servo Driver

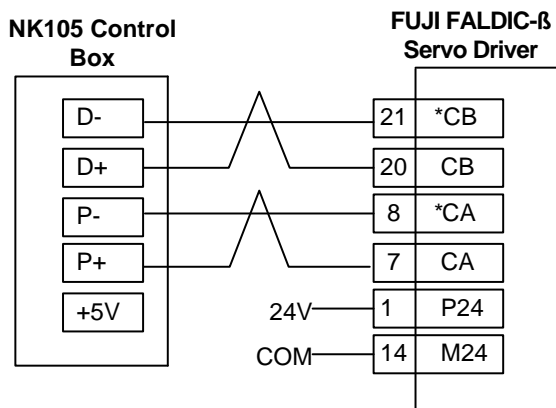

Fig. 10-8 Wiring diagram of NK105 and FUJI FALDIC-β servo driver



Wirings of X axis, Y axis, and Z axis are the same, and the brake of Z axis is internally controlled.

10.2.8. Wiring Diagram of STONE GS Servo Driver

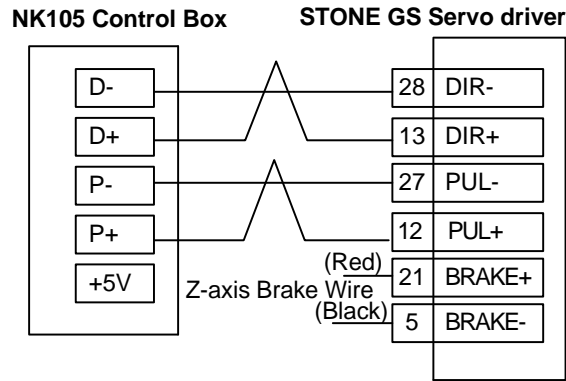

Fig. 10-9 Wiring diagram of NK105 and STONE GS servo driver



Wirings of X axis, Y axis, and Z axis are the same. Only Z axis has two brake signal lines which can be connected to relay to control brake.

11. Software License Agreement

Important—Read Carefully before Using This Product:

The term “Software Product” includes all copies of the licensed software and its documentation. This license agreement is a legal agreement between You (either an individual, a legal entity or any affiliated companies or other entities) and Weihong Electronic Technology Co., Ltd. (hereinafter referred to as Weihong Company). By installing, copying, or otherwise using the Software Product, you agree to be bound by the terms and conditions of this license. Unless otherwise stated in this agreement, you shall not use, copy, revise, rent, or transfer the Software product or any part of the Software Product for any other purposes.

Description of Further Rights and Restrictions:

1. You may install for use one copy of the Software Product on a single machine;
2. You may make a copy of the Software Product for archive or backup purposes and the copy is to be used on this machine only;
3. You may transfer the Software Product and the license agreement to a third party, provided that the third party accepts the terms and conditions stated in this agreement, with prior express permission from Weihong Company;
4. When transfer confirmed, you shall transfer all the copies of the original documents and the supplementary documents to the third party or destroy all the copies un-transferred;
5. You can use the Software Product on a network server or intranet server only if it is stipulated in explicit terms that you are allowed to use the Software Product on a network server or intranet server, or you have purchased license for each node and terminal using the Software Product;
6. You may NOT sublicense, assign or transfer the license agreement;
7. You may NOT or direct any third party to reverse engineer, decompile or disassemble the Software Product;
8. You may NOT copy or transfer the Software Product or any part of the Software Product unless otherwise expressly stated in this agreement;
9. The license agreement shall be terminated automatically upon you transfer the Software Product or copies of all or part of the Software Product to a third party.

Intellectual Property Rights Notice:

The Software Product and all intellectual property rights therein (including but not limited to any all copyrights, patents, trademarks, and publicity rights) are owned by Weihong Company. The Software Product is protected for Weihong Company on the basis of copyright law and international treaty provisions as well as on the basis of other laws and agreements regarding intellectual property. You

are not allowed to remove the copyright statement made in the Software Product, and guarantee that you shall copy the copyright statement in all copies of the Software Product or of any part of the Software Product. You are obliged to stop any form of illegal copying of the Software Product and accompanying materials.

After-sales Guarantee:

Weihong Company guarantees that for 90 days from the date of shipment the software carrier will be free from defects in materials and workmanship. When such a defect has been confirmed, our only responsibility is to replace the software carrier. This remedy is your exclusive remedy. This after-sales guarantee is invalid for any carrier defect caused by accidents, abuses or maloperation. The replaced software carrier enjoys the remaining guarantee time of the original software carrier or of a 30-day guarantee time, whichever is longer.

Except as the after-sales guarantee made above, the Software Product does not enjoy any other form of after-sale guarantee.

Limitation of Liability:

The above guarantee, whether made explicitly or by implication, constitutes the entire contents of the guarantee, including guarantee for the commerciality and applicability of special application aim. Whether you follow other terms in this agreement or not, Weihong Company, as well as its agents and sales staff, will not be responsible for any profits loss, availability loss, business break-off or any forms of indirect, special, accidental or inevitable damage or claim made by any third party, generated from the using of the Software Product, even if Weihong Company has been informed of the possible occurrence of such events in advance.

Termination:

This license may be terminated by Weihong Company at any time once you violate any terms or conditions made in this agreement. Once the license is terminated, you are obliged to destroy all the copies of the Software Product or return them to Weihong Company.

Applicable Law:

Copyright Law, Regulations for the Protection of Computer Software, Patent Law and other relevant laws and regulations.

Now, we affirm that you have already read through this agreement and understood it thoroughly and agreed to comply with all of the terms and conditions of this agreement strictly.

Weihong Electronic Technology Co., Ltd.