

# WANHAO DUPLICATOR 10 CATALOGUE



# YOUR SMART WANHAO D10 3D PRINTER

## Stable & Efficient Structure

- A. Invisible cable design.
- B. Basic 3D printer only.
- C. Simple and durable.
- D. Toy looking for family usage.
- E. Most affordable for students.
- F. WANHAO University support item.
- G. Create by students and work for students.
- H. Local service distributor available.
- I. Free online teaching courses.
- J. 7\*24H support team available.
- K. Multi language support.



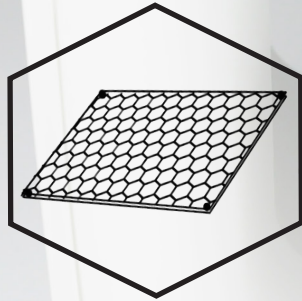

## Honeycomb Print Surface

Better sticking  
Honeycomb building plate  
Bendingable after printing  
Easy remove after printing

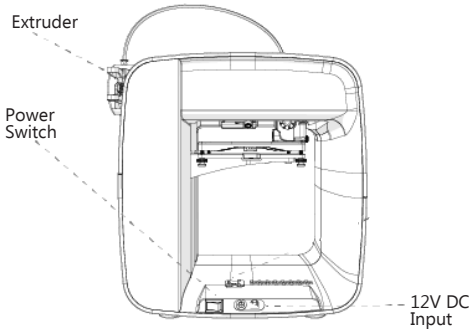
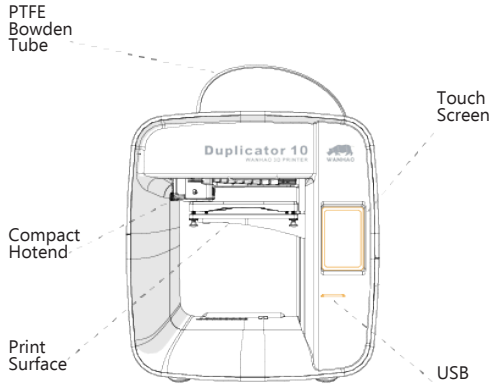

## Technical Specifications:

Max Printing Space:	116*116*125mm
Nozzle Diameter:	0.4mm
Max. Travel Speed:	200mm/s
Max. Printing Speed:	80mm/s
Compatible Filaments:	WANHAO PLA
Layer Height:	0.05-0.3(for 0.4mm Nozzle)
Data Transfer:	SD card /USB cable link printing
Primary attributes of the technology:	PLA printer, entrance level printer
Extruder system:	MK12 extruder
Leveling:	Pre-leveled
Extruder Quantity:	1
Filament diameter/light:	1.75mm
Case Material:	Plastic Case
Software:	CURA, host by Repitator, Simplify 3D
Accuracy:	X 0.012mm Y 0.012mm Z 0.0025mm
Platform:	Plastic platform W/O heating
LCD display:	English/ customized any language





## Stable & Efficient Structure

Standard 0.4mm nozzle

MK12 extruder

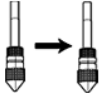
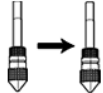
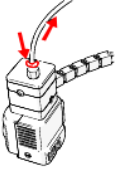
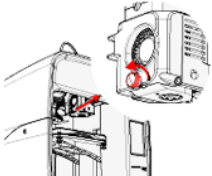
Balance between Speed and Quality

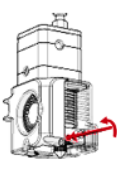
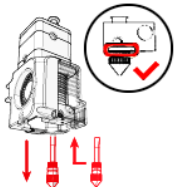
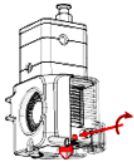
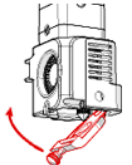
<p><b>1</b></p>  <p>Replace the Nozzle</p>	<p><b>2</b></p> <p>This guide is used to quickly replace the printer nozzle</p>  <p>Please confirm the printer doesn't install any filaments, or cut off the filaments installed</p>	<p><b>3</b></p>  <p>50°C / 200°C</p> <p>Waiting for the nozzle temperature to cool down below 50°C. And confirm that the tube has been removed</p>
<p><b>4</b></p>  <p>Find the hand wrench screw and rotate it in the direction of the picture for 3-5 laps</p>	<p><b>5</b></p>  <p>Remove the fan duct</p>	<p><b>6</b></p>  <p>Insert the hexagon wrench from the front of the hot head and loosen the screw</p>
<p><b>7</b></p>  <p>Pull out the used nozzle, insert a new nozzle till the correct position</p>	<p><b>8</b></p>  <p>Insert the hexagon wrench from the front of the hot head and tighten the screw</p>	<p><b>9</b></p>  <p>Install the fan duct and tighten the hand wrench screw</p>

# WANHAO DUPLICATOR 10 VISUAL DISPLAY

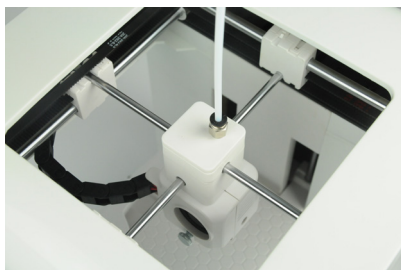

# PRINTER FIRMWARE DISPLAY

